

GEM

GEM OWNER'S MANUAL 2023

GEM E2
GEM E4
GEM E6
GEM eL XD

waev



WARNING

Read, understand, and follow all of the instructions and safety precautions in this manual and on all product labels.

Failure to follow the safety precautions could result in serious injury or death.



WARNING

Operating, servicing, and maintaining a passenger vehicle or off-road vehicle can expose you to chemicals including engine exhaust, carbon monoxide, phthalates, and lead, which are known to the State of California to cause cancer and birth defects or other reproductive harm. To minimize exposure, avoid breathing exhaust, do not idle the engine except as necessary, service your vehicle in a well-ventilated area and wear gloves or wash your hands frequently when servicing your vehicle.

For more information go to www.P65Warnings.ca.gov/passenger-vehicle.



2023 Owner's Manual for
Maintenance and Safety

WAEV

This vehicle was manufactured by GEM WAEV LLC, a wholly-owned subsidiary of Waev Inc.

QR Code® is a registered trademark of DENSO WAVE INCORPORATED. Brammo® is a registered trademark of Brammo Inc. MACPHERSON MACPHERSON RIDE® is a registered trademark of Aftermarket Auto Parts Alliance, Inc. Bluetooth® is a registered trademark of Bluetooth Sig, Inc. WD-40® is registered to WD-40 Manufacturing Company. Tread Lightly® is a registered trademark of the United States Department of Agriculture. OSHA® is a registered trademark of the Occupational Safety and Health Administration, U.S. Dept. of Labor.

Copyright 2022 GEM WAEV LLC. All information contained within this publication is based on the latest product information at the time of publication. Due to constant improvements in the design and quality of production components, some minor discrepancies may result between the actual vehicle and the information presented in this publication. Depictions and/or procedures in this publication are intended for reference use only. No liability can be accepted for omissions or inaccuracies. Any reprinting or reuse of the depictions and/or procedures contained within, whether whole or in part, is expressly prohibited.

The original instructions for this vehicle are in English. Other languages are provided as translations of the original instructions.

Printed in U.S.A.
9941150-EN Rev 01

SAFETY SYMBOLS AND SIGNAL WORDS

The following signal words and symbols appear throughout this manual and on your vehicle. Your safety is involved when these words and symbols are used. Become familiar with their meanings before reading the manual.

DANGER

DANGER indicates a hazardous situation which, if not avoided, WILL result in death or serious injury.

WARNING

WARNING indicates a hazardous situation which, if not avoided, COULD result in death or serious injury.

CAUTION

CAUTION indicates a hazardous situation which, if not avoided, COULD result in minor to moderate injury.

NOTICE

NOTICE provides key information by clarifying instructions.

IMPORTANT

IMPORTANT provides key reminders during disassembly, assembly, and inspection of components.

The Prohibition Safety Sign indicates an action NOT to take in order to avoid a hazard.



The Mandatory Action Sign indicates an action that NEEDS to be taken to avoid a hazard.



TABLE OF CONTENTS

Introduction	7
Safety	11
Features and Controls	25
Operation	53
Maintenance	63
Specifications	83
Warranty	87
Maintenance Log	93

INTRODUCTION

OVERVIEW

Please familiarize yourself with all laws and regulations concerning the operation of the vehicle in your area.

This manual applies to the following GEM vehicles:

- GEM e2 (two-passenger)
- GEM e4 (four-passenger)
- GEM e6 (six-passenger)
- GEM eL XD (two-passenger extra duty long-bed)

GEM CUSTOMER SERVICE

Phone	855-RIDEGEM (855-743-3436)
Web	www.gemcar.com

For the most up-to-date owner's manual and product information, see the GEM WAEV website.

GENERAL WARNINGS



WARNING

Failure to follow the warnings contained in this manual can result in severe injury or death.

Special precautions must be followed when owning and operating a battery-powered vehicle. This vehicle is not a toy and can be hazardous to operate. This vehicle handles differently than other vehicles. A collision or rollover can occur quickly, even during routine maneuvers, if you fail to take proper precautions.

- Read this owner's manual. Understand all safety warnings, precautions and operating procedures before operating the vehicle. Keep this manual with the vehicle at all times.
- Never permit a guest to operate this vehicle unless the guest has read this manual and all product labels.
- Never use this vehicle with drugs or alcohol, as these conditions impair judgment and reduce operator reaction time.
- Operate this vehicle only on public or private roads where speed limits are appropriate for low speed vehicles. Be familiar with motor vehicle laws in your area of operation. Do not operate this vehicle in situations where it could become an obstacle or an annoyance for faster-moving traffic.

INTRODUCTION

MANUFACTURER'S LABEL

Record your vehicle's identification numbers in the spaces provided.

The Vehicle Identification Number (VIN) is stamped on a tag affixed to the left dash at the base of the windshield ①. The VIN is also printed on the manufacturer's label ①, which is located on the left rear section of the interior roof panel.

The VIN indicates the model year, model type and serial number of your vehicle. The manufacturer's label also contains the Gross Vehicle Weight Rating (GVWR) and Gross Axle Weight Rating (GAWR) information for your vehicle. *Never exceed the GVWR or the GAWR.* See page 17.

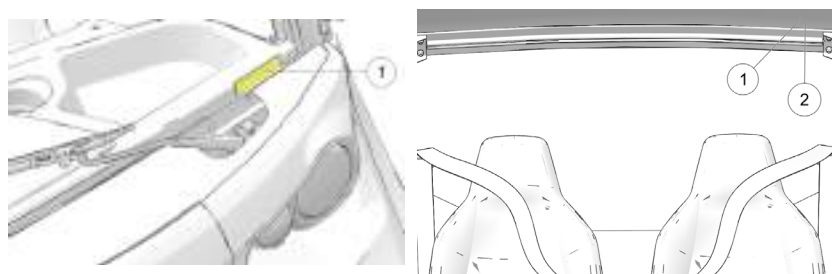

Vehicle Identification Number (VIN):	
Vehicle Model Number:	

VEHICLE EMISSION CONTROL INFORMATION (VECI)

The Vehicle Emission Control Information (VECI) label ② is located on the left rear section of the interior roof panel, below the manufacturer's label.

RADIO COMPLIANCE STATEMENTS

The following statements apply to radio components offered with this vehicle. These include but may not be limited to the touchscreen display.

This device complies with part 15 of the FCC Rules. Operation is subject to the following two conditions: (1) This device may not cause harmful interference, and (2) this device must accept any interference received, including interference that may cause undesired operation.

This device complies with FCC RF radiation exposure limits for general population.

This device contains license-exempt transmitter(s)/receiver(s) that comply with Innovation, Science and Economic Development Canada's license-exempt RSS (s). Operation is subject to the following two conditions:

1. This device may not cause interference.
2. This device must accept any interference, including interference that may cause undesired operation of the device.

CAUTION

This equipment complies with part 15 of the Federal Communications Commission (FCC) rules.

These requirements are intended to provide reasonable protection against harmful interference in a residential installation. This equipment generates, uses and can radiate radio frequency energy and, if not installed and used in accordance with the instructions, may cause harmful interference to radio communications. However, there is no guarantee that interference will not occur in a particular installation.

If this equipment does cause harmful interference to radio or television reception, which can be determined by turning the equipment off and on, the user is encouraged to try to correct the interference by one or more of the following measures:

- Reorient or relocate the receiving antenna.
- Increase the separation between the equipment and receiver.
- Connect the equipment into an outlet on a circuit different from that to which the receiver is connected.
- Consult the dealer or an experienced radio/TV technician for help.

Changes or modifications to this equipment not expressly approved by the party responsible for compliance could void the user's authority to operate the equipment.

REPLACEMENT KEYS

For an extra or replacement key for the ignition or accessory locks, a blank can be ordered from any GEM Dealer. The necessary blank can be identified by providing the Vehicle Identification Number to your Dealer. The blank will be cut using your existing key to create a spare, but not all dealers are able to cut key blanks and it may need to be taken elsewhere to be cut. If both of your keys have been lost, the ignition will need to be replaced.

SAFETY

AUDIBLE WARNING DEVICE

Your new GEM product is equipped with an Acoustic Vehicle Alerting System (AVAS). This system includes a noise emitting device designed in compliance with FMVSS-141 *Minimum Sound Requirements for Hybrid and Electric Vehicles*. The purpose of this device is to provide an audible alert to aid in pedestrian awareness of an active vehicle. The vehicle will emit a specific audible alert to enhance its ability to be detected during critical operating scenarios including: stationary, reverse and constant speeds up to 18.64 mph (30 km/h).

SAFETY LABELS AND LOCATIONS

Warning labels have been placed on the vehicle for your protection. Read and follow the instructions of the labels on the vehicle carefully. If any of the labels depicted in this manual differ from the labels on your vehicle, always read and follow the instructions of the labels *on the vehicle*.

If any label becomes illegible or comes off, contact your authorized GEM dealer to purchase a replacement. Replacement *safety* labels are provided at no charge. The part number is printed on the label.

SAFETY

ROOF WARNINGS AND DISCLOSURES

The roof warnings and disclosures are located on the underside of the roof.

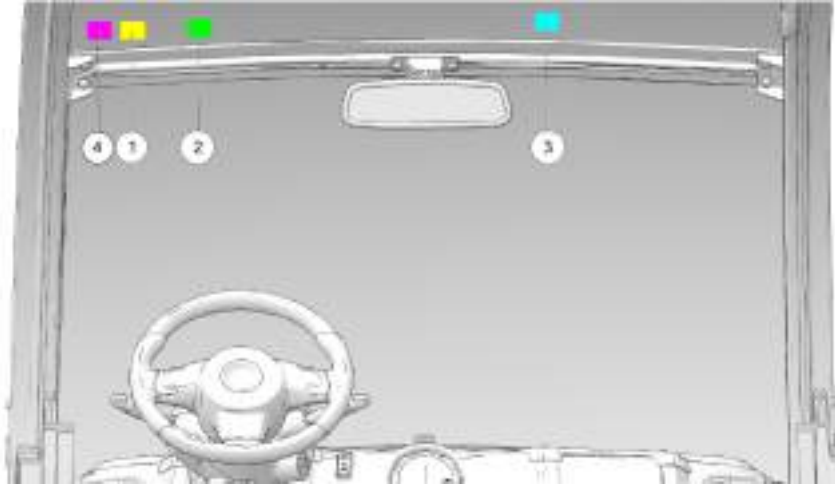

- | | |
|---|------------------------------------|
| ① Low Speed Vehicle Disclosure | ③ Cargo Limit Warning (eL XD only) |
| ② Ontario Low Speed Vehicle WarningLabel (Canadian Models only) | ④ Rollover Risk Warning |

LOW SPEED VEHICLE DISCLOSURE

This Vehicle:

- Has a maximum speed of greater than 20 miles per hour, but not greater than 25 miles per hour;
- May be a hazard on the roadways if it impedes traffic;
- May subject the driver to citations for impeding traffic;
- May not be equipped with such safety features as bumpers, a padded dashboard, visors, and a tamper-resistant odometer;
- May be subject to other restrictions specific to the state or local jurisdiction in which it is operated; and
- Shall not be operated on a public highway with a speed limit in excess of the maximum specified by the state or local jurisdiction in which it is operated, including:
 - NY: Shall not be operated on a public highway with a speed limit in excess of 35 miles per hour.
 - MD and IL: Shall not be operated on a public highway with a speed limit in excess of 30 miles per hour.

ONTARIO LOW SPEED VEHICLE WARNING LABEL (CANADIAN MODELS ONLY)

In accordance with the Ontario, Canada LSV program, warning label 7188616 will be placed by the dealer on models sold in Ontario to support Low Speed Vehicle Registration in this region. The recommended location for this label is on the left section of the interior roof panel.

WARNING

- This low-speed vehicle cannot attain a rate of speed greater than 40 kilometres per hour.
- This low-speed vehicle is not equipped with the safety features customarily found in passenger cars, and low-speed vehicle owners and drivers are advised to confirm the vehicle's safety features with the manufacturer or importer.
- The operation of this low-speed vehicle is restricted to highways the rate of speed for which is not greater than 50 kilometres per hour, and may be subject to other operating requirements imposed by law. Low-speed vehicle owners and drivers are advised to confirm the operating requirements that apply with respect to the highways on which they intend to operate the vehicle.
- This low-speed vehicle emits little or no noise, and low-speed vehicle owners and drivers are advised that, as a result, other road users may not be alerted to the presence of the vehicle.

CARGO LIMIT WARNING (EL XD ONLY)

⚠ WARNING

- Never carry passengers on rear platform
- Passengers can be thrown off. This can cause serious injury or death.

⚠ WARNING

- Distribute weight evenly.
- Ensure loads are properly secured.
- Do not exceed gross vehicle weight rating in owner's manual.



SAFETY

RATING	EL XD
A. Occupant Capacity	300 lb (136 kg)
B. Cargo Capacity (includes cargo, bed load, and optional equipment)	1150 lb (499 kg)*
C: Maximum Trailer Tongue Weight	150 lb (68 kg)
D: Maximum Gross Trailer Weight	1100 lb (499 kg)
A + B = Vehicle Rated Capacity	1450 lb (658 kg)
A + B + D, not to exceed stated Vehicle Combination Rated Capacity	1450 lb (658 kg)
Vehicle Dry Weight (Base Model)	1585 lb (719 kg)
A + B + Vehicle Dry Weight = Maximum Gross Vehicle Weight	2999 lb (1360 kg)
A + B + D + Vehicle Dry Weight, not to exceed stated Maximum Gross Vehicle Combination Weight	2999 lb (1360 kg)
* Cargo Capacity and Vehicle Dry Weight are directly affected by the vehicles features, options & accessories and will be unique to each specific configuration.	

ROLLOVER RISK WARNING

⚠ WARNING

Avoid Abrupt Maneuvers and Excessive Speed. Always Buckle Up. See Owner's Manual for further Information.

SEAT BELT WARNING

Seat belt warnings ⑤ are located near the shoulder anchor for each seat belt.

⚠ WARNING

TO AVOID PERSONAL INJURY OR DEATH: Always fasten your seat belt.

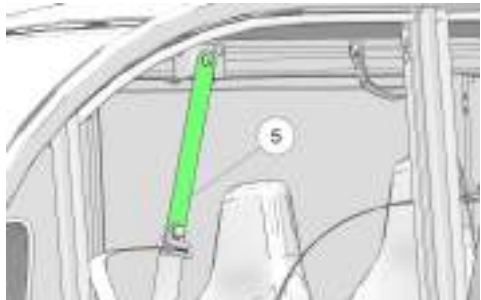

CARGO LIMIT WARNING (E2/E4/E6)

The cargo limit cargo warning label ⑥ is located at the rear of the vehicle.



⚠ WARNING

- Never carry passengers on rear platform.
- Passengers can be thrown off. This can cause serious injury or death.

⚠ WARNING

STANDARD CARGO LIMIT 15 kg / 33 lbs.
S-BED/TRUNK-BACK CARGO LIMIT 150 kg / 330 lbs.

Distribute weight evenly. Ensure loads are properly secured. Total weight of passengers, accessories, and cargo must not exceed gross vehicle weight rating in owner's manual.



OPERATOR SAFETY

 **WARNING**

Serious injury or death can result if you do not follow these instructions and procedures, which are outlined in further detail within this owner's manual.

- Read this manual and all labels carefully. Follow the operating procedures described.
- Never allow anyone under age 16 to operate this vehicle and never allow anyone without a valid driver's license to operate this vehicle.
- Never permit a guest to operate this vehicle unless the guest has read this manual and all product labels.
- Always make sure the seat belts are secured for operator and all passengers before operating.
- Never exceed the maximum occupant capacity of your vehicle:

GEM e2	2 occupants
GEM e4	4 occupants
GEM e6	6 occupants
GEM eL XD	2 occupants

- Never exceed the gross vehicle weight rating (GVWR) of your vehicle.
- The cab frame is not designed or intended to provide rollover protection. Avoid situations that could result in a rollover.
- Always be sure there are no obstacles or people behind your vehicle when operating in reverse. When it's safe to proceed in reverse, move slowly. Avoid turning at sharp angles in reverse.
- Always use the proper size and type of tires and always maintain proper tire pressure as specified in this manual and on safety labels.
- Never modify this vehicle with non GEM-approved parts and/or accessories.
- Always set the park brake and remove the key when leaving the vehicle unattended.
- The voltage in the battery pack is sufficient to cause death by electrocution. With the exception of battery inspections and fluid level maintenance, if applicable, never attempt to perform service on the electric drive system, including the battery pack, unless you are properly trained to work on electrical systems. Your authorized GEM dealer can provide battery-related service.
- Do not carry a passenger until you have at least two hours of driving experience with this vehicle.
- Always keep arms and legs inside the cab frame while the vehicle is in motion.
- Always keep both hands on the steering wheel and both feet on the floorboards of the vehicle during operation.
- Never consume alcohol or drugs before or while operating this vehicle.

- Never operate at excessive speeds. Always travel at a speed proper for the traffic, visibility and operating conditions, and your experience.
- Never attempt wheelies, jumps, doughnuts or other driving stunts.
- Always inspect your vehicle each time you use it to make sure it's in safe operating condition. Always follow the inspection and maintenance procedures and schedules described in this manual.
- Never operate on excessively rough, slippery or loose terrain.
- Always follow proper procedures for turning. Practice turning at slow speeds before attempting to turn at faster speeds. Never turn at excessive speeds.
- Always have this vehicle inspected by an authorized GEM service dealer if it has been involved in an accident.

GROSS VEHICLE WEIGHT RATING (GVWR)

WARNING

Exceeding the gross vehicle weight rating of your vehicle can reduce stability and handling and could cause loss of control. NEVER exceed the GVWR of your vehicle.

The maximum *payload capacity* of your vehicle is the maximum weight you may add to your vehicle *without exceeding the GVWR*. This capacity is determined by calculating the difference between your vehicle's GVWR and wet weight.

Refer to the specification section of this manual or the Manufacturer's Label on the vehicle for model-specific information.

When determining the weight, you will be adding to your vehicle, and to ensure you do not exceed the maximum payload capacity, include the following:

- operator body weight
- passenger body weight
- weight of all occupants' apparel and items in or on apparel
- weight of any options or accessories and their contents
- weight of any additional cargo on the vehicle
- weight is distributed evenly. Do not exceed the GAWR, see page 83
- weight distribution does not extend beyond the boundaries of the vehicle

SAFETY

EQUIPMENT MODIFICATIONS

Never install any accessory that grounds to the vehicle chassis. The chassis is a floating ground to protect against electrical short circuits and hazards.

Do not install any non-GEM-approved accessory or modify the vehicle including for the purpose of increasing speed or power.

A warranty claim on your GEM vehicle may be rejected if the failure is believed to be caused by non-GEM-approved equipment and/or modifications.

WARNING

Any modifications or installation of non-GEM-approved accessories could create a substantial safety hazard and increase the risk of bodily injury.

The addition of certain accessories, including (but not limited to) accessory boxes or large racks, may change the handling characteristics of the vehicle. Use only GEM-approved accessories, and familiarize yourself with their function and effect on the vehicle.

SEAT BELTS

Riding in this vehicle without wearing the seat belt increases the risk of serious injury in the event of an accident or sudden stop. Occupants must wear seat belts at all times. Always make sure the seat belts are secured for operator and all passengers before operating.

WARNING

Always wear your seat belt. Ensure the seat belts are secured for operator and all passengers before operating. Failure to do so could result in the risk of serious injury or death.

OPERATING WITHOUT INSTRUCTION

Operating this vehicle without proper instruction increases the risk of an accident. The operator must understand how to operate the vehicle properly in different situations and on different types of terrain. All operators must read and understand the Owner's Manual and all warning and instruction labels before operating the vehicle.



VENTILATION WHEN CHARGING BATTERIES (LEAD ACID BATTERIES ONLY)

WARNING

Maintenance and storage areas for Low Speed Vehicles (LSVs) must be properly ventilated, in accordance with applicable fire codes and ordinances, to prevent the accumulation of volatile hydrogen gas. Hydrogen gas is emitted during the LSV battery charging process. If not properly ventilated, hydrogen gas has a tendency to accumulate in pockets near the ceiling which can lead to fires and explosions. The amount of hydrogen gas emitted during charging depends on a number of factors including the condition of the batteries, the output rate of the battery charger, and the amount of time the batteries are charged.

Always ensure a minimum of 5 air changes per hour in the charging area (depending on factors such as the number of vehicles charging).

NOTICE

The minimum number of air changes required per hour during LSV charging depends on a number of factors including the number of vehicles charging, the size of the storage space, and the amount of hydrogen gas emitted. At least 1 air change per hour is recommended for 1 vehicle, but up to 5 air changes per hour can be required for multiple vehicles.

NOTICE

The process, SAE J1718, can be used to determine the amount of hydrogen gas an electric vehicle will generate while being charged in a residential garage.

Consult applicable fire and safety codes for more specific ventilation requirements and to ensure the proper use of explosion proof electrical equipment.

FAILURE TO INSPECT BEFORE OPERATING

WARNING

Failure to inspect and verify that the vehicle is in safe operating condition before operating increases the risk of an accident. Always inspect the vehicle before each use to make sure it's in safe operating condition. Always follow all inspection and maintenance procedures and schedules described in the owner's manual. See the Periodic Maintenance Section of the Maintenance Chapter.

SAFETY

USING ALCOHOL OR DRUGS

 **WARNING**

Operating the vehicle after consuming alcohol or drugs could adversely affect operator judgment, reaction time, balance and perception..

Never drink alcohol or use drugs or medications before or while operating this vehicle.

OPERATING A DAMAGED VEHICLE

 **CAUTION**

Operating a damaged vehicle can result in an accident. After any rollover or accident, have an authorized GEM dealer or qualified service dealer inspect the entire machine for possible damage, including (but not limited to) brakes, accelerator, steering system and electrical system.

OPERATING AT EXCESSIVE SPEEDS

 **CAUTION**

Operating this vehicle at excessive speeds increases the operator's risk of losing control. Always operate at a speed that's appropriate for your skills and the traffic, visibility and operating conditions.

EXHIBITION DRIVING

 **CAUTION**

Exhibition driving increases the risk of an accident or rollover. Never attempt wheelies, jumps, doughnuts or other stunts. Avoid exhibition driving.

TURNING IMPROPERLY

 **CAUTION**

Turning improperly could cause loss of traction, loss of control, accident or rollover. Always follow proper procedures for turning. Never turn abruptly or at sharp angles. Never turn at high speeds. Practice turning at slow speeds before attempting to turn at faster speeds.

VEHICLE ROLLOVER

WARNING

Vehicle rollover could cause serious injury or death. The cab frame is not designed or intended to provide rollover protection. Always make sure the seat belts are secured for operator and all passengers before operating. Avoid situations that could result in a rollover. Avoid sharp turns and abrupt steering maneuvers.

CARRYING CARGO

Carrying loads on the roof could damage the roof and affect vehicle handling, which could result in an accident or rollover. Never carry loads on the roof of the vehicle.

Never exceed the stated load capacity for this vehicle. Cargo should be properly distributed and securely attached.

Reduce speed and follow the instructions on cargo warning labels for hauling cargo. Allow a greater distance for braking.

IMPROPER TIRE MAINTENANCE

CAUTION

Operating this vehicle with improper tires or with improper or uneven tire pressure could cause loss of control or accident. Always use the size and type of tires specified for your vehicle.
Always maintain proper tire pressure as described in the owner's manual and on safety labels.

UNAUTHORIZED USE OF THE VEHICLE

Leaving the keys in the vehicle can lead to unauthorized use of the vehicle by someone without a driver's license or without proper training. This could result in an accident or rollover. Always remove the key when the vehicle is not in use.

HOT COMPONENTS

 **WARNING**

The motor, controller, and components are very hot during and after use of the vehicle. Hot components can cause burns and fire. Do not touch hot drive system components. Always keep combustible materials away from the drive system. Use caution when traveling near or through grass, brush or muddy conditions, especially dry grass or brush, and always inspect areas near the drive system afterwards. Promptly remove any grass or debris clinging to the vehicle.

PRECAUTIONS DURING MAINTENANCE

 **DANGER**

The voltage in the battery pack is sufficient to cause death by electrocution. With the exception of battery inspections, never attempt to perform service on the electric drive system, including the battery pack, unless you are properly trained to work on electrical systems.

Your authorized GEM dealer can provide battery- related service.

 **WARNING**

Do not work in or near the battery compartment or on any other electrical component of the vehicle while charging the batteries.

 **WARNING**

Before servicing the vehicle's electrical system, always disconnect the service disconnect first, then disconnect any electrical accessory connections, then disconnect the negative cable from the 12-volt battery, then disconnect the negative terminal from the main battery pack. For more information about disconnecting the service disconnect, see the Service Disconnect section for details.

Always follow all safety instructions in the maintenance portion of this owner's manual, as well as the following:

- Park the vehicle on an level surface.
- Make sure the vehicle is properly immobilized before beginning any maintenance.
- Always block the chassis securely before working under the vehicle.
- Turn the key off and remove it from the vehicle.
- Insulate any tools used within the battery area to prevent sparks or battery explosion caused by shorting the battery terminals or wiring. Remove the batteries, or cover the exposed terminals with an insulating material.

FOR MORE INFORMATION ABOUT SAFETY PLEASE CONTACT GEM CUSTOMER SERVICE.

GEM CUSTOMER SERVICE

Phone: 855 - RIDE GEM (855-743-3436)

Web: www.gemcar.com

FEATURES AND CONTROLS

CONSOLE

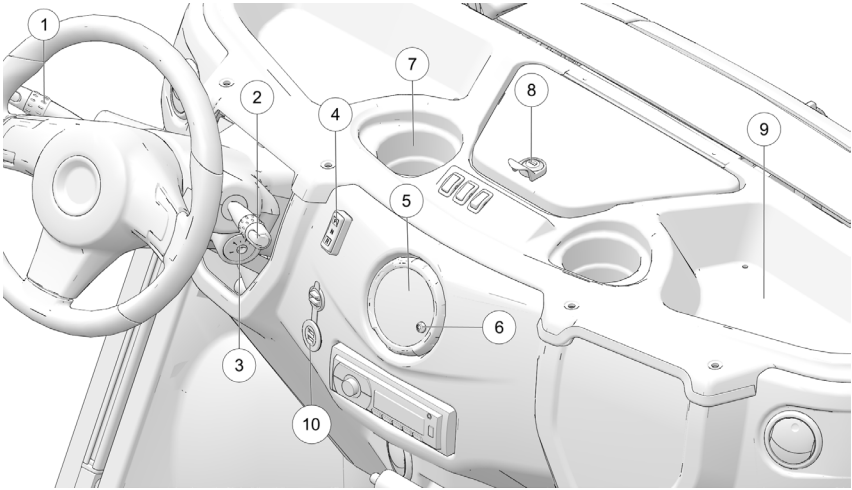

① Left Control Lever

② Right Control Lever

③ Key Switch

④ Drive Mode Switch

⑤ Gauge

⑥ Trip Switch/MODE Switch

⑦ Cup Holder

⑧ Glove Box Lock

⑨ Storage Tray

⑩ USB Port

FEATURES AND CONTROLS

LEFT CONTROL LEVER

The left control lever contains the turn signal switch, the horn switch, the headlight on/off switch and the high/low headlight beam switch.

TURN SIGNAL SWITCH

NOTICE

The key must be in the ON position to activate the turn signals.

Check turn signal lamps before each ride. When driving, activate a turn signal before turning to alert others of your intentions.

Move the lever upward ① to signal a right turn. Move the lever downward ② to signal a left turn. The corresponding turn signal lamps on the front and rear of the vehicle will flash. The corresponding turn indicator in the LCD display will also flash.

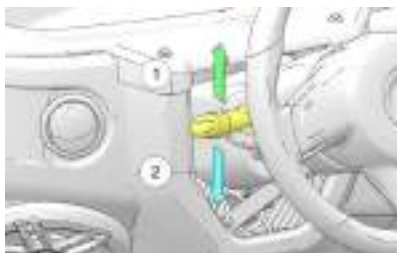

HORN SWITCH

Press the tip of the left control lever ① inward to sound the horn.

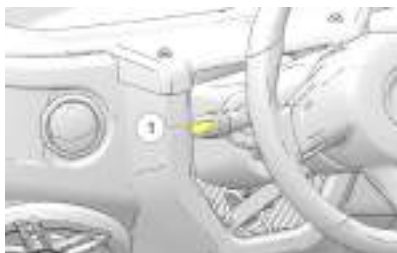

HEADLIGHT HIGH BEAM/LOW BEAM SWITCH

Pull the control lever toward the driver's seat to toggle the headlights between high beam and low beam.

RIGHT CONTROL LEVER

The right control lever contains the hazard signal switch, and the windshield wiper and washer switches (if equipped).

HAZARD SIGNAL SWITCH

Press the tip of the lever inward ① to cause all turn signal lamps to flash simultaneously. Use this feature to alert others of an emergency or other situation requiring caution, especially if your vehicle becomes disabled on or near a road. Press the switch again to cancel the hazard signals.



WINDSHIELD WIPER

Rotate the knurled barrel ① forward to turn the windshield wipers on. Pull the control lever toward the driver's seat to activate the washer (if equipped).

If the wiper fails to work, check for a blown fuse at the fuse block. See page 67.



⚠ CAUTION

A worn or damaged wiper blade could impair operator vision and result in an accident. A worn wiper blade could also damage windshield glass. Always replace worn or damaged wiper blades promptly.

FEATURES AND CONTROLS

KEY SWITCH

When the key is turned to the OFF position ①, the vehicle will not operate.

When the key is turned to the ON position ② (clockwise), the display will light up and all electrical functions can be used.



Leaving the key in the ON position will discharge the batteries. Always turn the key to the OFF position when not operating. Remove the key from the ignition to prevent unauthorized use.

If the key is left in the ON position and there are no user inputs from: the brake pedal, parking brake, seat belt, hazard or turn signal switches, the gear selector, and the headlight switch; the vehicle will enter sleep mode after some time to prevent the batteries from fully discharging. To exit the sleep mode, cycle the key switch to OFF and back to the ON position.

NOTICE

The steering column automatically locks when the ignition key is removed. The key only can be removed from the switch when it is in the OFF position.

WARNING

Never turn the key to the OFF position while the vehicle is in motion. This could lead to loss of speed control and loss of vehicle control, which could result in serious injury or death.

DRIVE MODE SWITCH

NOTICE

The malfunction light will illuminate after reversing direction if you press the accelerator pedal before coming to a complete stop.

Always come to a complete stop before reversing direction. To choose the forward option, push the top of the switch ①. Push the bottom of the switch to choose reverse operation ③. When the drive mode switch is in the center position ②, the vehicle is in neutral. The vehicle will not move if the accelerator is depressed.

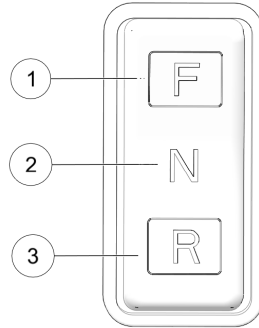

DIGITAL/ANALOG GAUGE

High-pressure water may damage components. Wash the vehicle by hand or with a garden hose using mild soap. Certain products, including insect repellents and chemicals, will damage the speedometer lens and other plastic surfaces. Do not use alcohol to clean the instrument cluster. Do not allow insect sprays to contact the lens.



SPEEDOMETER









When driving, the speedometer displays vehicle speed in either miles per hour (MPH) or kilometers per hour (km/h). See page 33.

MODE BUTTON

Use the MODE button to toggle through mode options. See page 33.

FEATURES AND CONTROLS

INDICATOR LAMPS

LAMP	INDICATES	CONDITION
	Vehicle Speed	When standard mode is selected, speed displays in miles per hour.
		When metric mode is selected, speed displays in kilometers per hour.
	Brake Indicator	The brake indicator illuminates when the park brake is engaged.
	Direction Indicators	A direction indicator flashes when a turn signal is active.
	Low Beam	This lamp illuminates when the headlamp switch is set to low beam.
	High Beam	This lamp illuminates when the headlamp switch is set to high beam.
	Chassis Fault	This lamp illuminates with the fault indicator on the rider information center to indicate a vehicle fault. See page 31. This lamp may also illuminate when the vehicle battery is charging.
	Seat Belt	When the key is turned on, the seat belt indicator lamp will illuminate if the driver's seat belt is not fastened. The lamp is a reminder to the operator to ensure all riders are wearing seat belts before operating.

RIDER INFORMATION CENTER

The rider information center is located in the instrument cluster. All segments will light up for one second at start-up. If the instrument cluster fails to illuminate, a battery over-voltage may have occurred and the instrument cluster may have shut off to protect the electronic speedometer. If this occurs, your dealer can provide proper diagnosis.

The information center is set to display standard units of measurement and a 12-hour clock at the factory.

- ① State of Charge Indicator
- ② Drive Mode/Charging Indicator
- ③ Information Display Indicator
- ④ Miles/Kilometers Indicator
- ⑤ Service Indicator



INFORMATION DISPLAY

This area will display clock, odometer, trip meter, or any existing fault codes or warning messages. See page 33.

MILES/KILOMETERS INDICATOR

The miles or kilometers indicator illuminates to indicate the mode of measurement selected.

SERVICE INDICATOR

When both the chassis fault lamp and the service indicator (wrench symbol) illuminate, use the mode button to toggle to VEH FAULT on the display, press and hold the mode button for 3 seconds to access the currently active trouble codes. Pressing the mode button momentarily will toggle through all current trouble codes. Your authorized GEM dealer can provide code details and diagnosis.

FEATURES AND CONTROLS

DRIVE MODE/CHARGING INDICATOR

This indicator displays the drive mode.

F = Forward

N = Neutral

R = Reverse (flashing)

C = Charging

STATE OF CHARGE

This indicator illuminates when the key is turned on. It also illuminates 8-10 seconds after the charging cord is connected, turning off when the batteries are 100% charged. To verify a full charge or to check the state of charge, turn the key on. As charge is depleted, illuminated bars begin to turn off from right to left. Remaining bars indicate remaining battery charge.

STATE OF CHARGE INDICATOR	
BARS	% OF CHARGE
1	Less Than 10
2	10-20
3	20-30
4	30-40
5	40-50
6	50-60
7	60-70
8	70-80
9	80-90
10	90-100

COLD TEMPERATURE OPERATION

Cold weather affects your electric vehicle's performance. The colder the ambient storage temperature, the slower the rate of charge and discharge of batteries. In the application of an electric vehicle like GEM, cold weather could decrease the achieved range on a charge.

INFORMATION DISPLAY MODE

This area will display clock, odometer, trip meter, or any existing fault codes or warning messages.

The display can be changed to show either standard or metric units of measurement for each of the following settings.

	Standard Display	Metrics Display
Distance	Miles	Kilometers
Temperature	Fahrenheit	Celsius
Time	12-Hour Clock	24-Hour Clock

1. Turn the key to the OFF position.
2. Press and *hold* the MODE button while turning the key to the ON position.
3. When the display flashes the distance setting, tap the MODE button to advance to the desired setting.
4. Press and *hold* the MODE button to save the setting and advance to the next display option.
5. Repeat the procedure to change remaining display settings.

NOTICE

To exit the set-up mode, turn the key off. Wait 5 seconds, then turn the key on. The gauge displays the mode that was displayed prior to setting the units.

CLOCK RESETTING

NOTICE

The clock must be reset any time the batteries have been disconnected or fully discharged.

FEATURES AND CONTROLS

1. Turn the key to the ON position. Use the MODE button to toggle to the clock display.
2. Press and *hold* the MODE button until the hour segment flashes. Release the button.
3. With the segment flashing, tap the MODE button to advance to the desired setting.
4. Press and *hold* the MODE button until the next segment flashes. Release the button.
5. Repeat steps 3-4 twice to set the 10-minute and 1-minute segments. After completing the 1-minute segment, step 4 will save the new settings and exit the clock mode.
6. Turn the key to the OFF position.

ODOMETER

The odometer displays the distance traveled by the vehicle since manufacture.

TRIP METER

The trip meter displays distance traveled since the last reset of the trip meter. To reset, toggle to the trip meter display. Press and hold the MODE button until the meter resets to zero.

STEERING WHEEL TILT ADJUSTMENT

If equipped, the steering wheel can be tilted upward or downward for rider preference.

Pull and hold the adjustment lever ① upward while moving the steering wheel upward or downward. Release the lever when the steering wheel is at the desired position.



GLOVE BOX

The glove box is equipped with a lock to protect items from theft or damage. Use the accessory lock key to lock and unlock the glove box door. Turn the key 1/4 turn counter-clockwise to unlock the door.

USB PORT

The fuse for the USB port ① is located under the hood in the fuse block. Always use fuses with the same type and rating.



NOTICE

Do not plug in devices requiring power exceeding 10.5 watts. Damage to the vehicle electrical system may occur or an accessory fuse may blow.

BATTERIES

BATTERY PACK

Your vehicle is equipped with a battery pack. This battery pack supplies the power needed to operate the vehicle.

These batteries perform best when recharged fully and often. *Recharge the batteries daily or after each use of the vehicle.*

FEATURES AND CONTROLS

NOTICE

Each vehicle is programmed at the factory for a particular battery type. Switching battery types should be done only by an authorized service technician. Your authorized GEM dealer can provide battery-related service.

To access the battery pack, remove any rear accessory back installed on the vehicle. See page 49. Release the battery pack access cover fasteners and remove the cover.

BATTERY PERFORMANCE TIPS

- New batteries will not perform to their fullest capacity until they have been discharged and recharged 20 to 30 times.
- Batteries should be fully charged before the first use.
- Recharge the batteries daily, or after each use of the vehicle.
- Always maintain a full charge on the batteries. For best battery life, avoid discharging the batteries more than 80%. When Charging, allow the full charge cycle to complete.
- Batteries should be at room temperature when recharging. Do not charge batteries at temperatures of 110 °F (43 °C) or higher.
- Range may be affected by road conditions, terrain, temperature and driving habits.

ON-BOARD CHARGER

The on-board battery charger is located under the hood.

The state of charge of the batteries displays in the rider information center and a “C” displays when the vehicle is charging.

When the vehicle will not be used for 10 or more days, connect the charger. For vehicles equipped with the standard charger, the state of charge of the batteries will be monitored, and charging will automatically be initialized when the state of charge drops below 97% or when 28 days have passed since the last charge completed.

This works best for maintenance free sealed Absorbent Glass Mat (AGM) batteries.

IMPORTANT

Avoid temperature extremes when choosing a storage area.

If the combined voltage of all batteries reaches 36 volts or less, a safety feature in the on-board charger will not allow the charger to activate. If this occurs, use the alternate charging method. See Batteries section in the Features and Controls chapter.

BATTERY CHARGING

Your vehicle is equipped with either a standard charge receptacle or a fast charge receptacle. The battery charge receptacle is located at the rear of the hood, just below the windshield.

WARNING

Using a non-recommended charge cord could result in fire, heat damage or charger failure, which could result in serious injury or death. Always use the recommended type of cord to charge the batteries.

WARNING

Charging from a circuit of lesser capacity and/or using a cord from the outlet to the vehicle that is not sufficient in wire gauge could create a fire hazard.

WARNING

Failure to provide adequate ventilation while charging batteries can result in an explosion. Hydrogen gas is emitted during charging and will rise and accumulate at the ceiling. Always ensure a minimum of five (5) air changes per hour in the charging area. Never charge the batteries in an area subject to a flame or spark, including areas containing gas or propane water heaters and furnaces. Do not smoke in the charging area.

NOTICE

Do not use a ground fault interrupt (GFI) type cord on a GFCI-protected outlet.

Always follow these precautions when charging:

- Position the vehicle on a level surface. Make sure the charging area is well ventilated.
- Make sure the key is off.
- Always use the recommended charge cord type.
- Inspect the charge cord for cracks, loose connections and frayed wiring. Never use a damaged charge cord.

FEATURES AND CONTROLS

NOTICE

A GFI (Ground Fault Interrupt) receptacle is recommended. See your authorized GEM dealer if you do not have a GFI receptacle at your regular recharge site.

- Make sure the charger uses a dedicated circuit to prevent overloading. If charging multiple vehicles, each vehicle should use a dedicated circuit.

STANDARD CHARGE RECEPTACLE

NOTICE

The standard charge receptacle ① is not compatible with the SAE J1772 standard.

The following information applies to use of the standard charge receptacle. See page 38 for information that applies to the use of the fast charge receptacle.

When charging the vehicle, always use the standard GEM charge cord.



1. To begin charging, align and insert the charge cord connector into the receptacle until it latches.
2. The lights on the charge station will indicate charging when the connection is made.
3. To remove the connector after the charge cycle is complete, press the release button and pull the connector out.

FAST CHARGE RECEPTACLE

The following information applies to use of the fast charge receptacle. See Batteries section in the Features and Controls Section for information that applies to the use of the standard charge receptacle.

NOTICE

Standard charge cord will not insert into the fast charge receptacle and damage may occur if forced.

1. Always use SAE J1772 approved charge stations and connectors.
2. To begin charging, align and insert the charge station connector into the

receptacle until it latches.

3. The lights on the charge station will indicate charging when the connection is made.
4. To remove the connector after the charge cycle is complete, press the release button and pull the connector out.

ALTERNATE BATTERY CHARGING METHOD

NOTICE

The following only applies to AGM Batteries. Do not attempt to charge Lithium Ion batteries with a charger other than the one on-board the vehicle.

If the combined voltage of all batteries reaches 36 volts or less, a safety feature in the on-board charger will not allow the charger to activate. Use the alternate charging method to add a small charge to each battery separately. The on-board charger will then activate properly to recharge all batteries to a full charge.

Use a 12-volt battery charger to charge 12-volt batteries. Charge each battery individually.

Use a 12-volt charger to charge 6-volt batteries. Charge in four groups, each consisting of two sequentially wired batteries.

1. Set the battery charger to the medium amp setting (10 to 30 amps).
2. Charge each battery for 10-20 minutes.
3. Move quickly from battery to battery, as this is only a residual charge and it will dissipate in a short period of time.
4. After charging the last battery, remove the off-board charger leads and plug the vehicle in.
5. If the on-board charger does not recognize the residual charge and activate, repeat the alternate charging method.

FEATURES AND CONTROLS

NOTICE

It is not necessary to remove or disconnect battery post connections during the alternate charging method.

BATTERY HANDLING PRECAUTIONS

WARNING

Do not work in or near the battery compartment or on any other electrical component of the vehicle while charging the batteries.

Before servicing the vehicle's electrical system, always disconnect the service disconnect first, then disconnect any electrical accessory connections, then disconnect the negative cable from the 12-volt battery, then disconnect the negative terminal from the main battery pack. See Service Disconnect section in the Features and Control chapter for more information. This will disable the vehicle by disconnecting the battery pack from the motor. It does not disable the battery pack. HIGH VOLTAGE will be present at the battery terminals and contactor.

HIGH BATTERY VOLTAGE IS ALWAYS PRESENT. DO NOT TOUCH THE BATTERY TERMINALS.

- Always make sure that all 12-volt electrical accessories are grounded directly to the negative (-) post on the terminal board. Never use the chassis or body as a ground connection. See 12-Volt Terminal Board Connections section in the Features and Controls chapter.
- Make sure vent caps are installed properly and securely during vehicle operation and battery charging.
- Never connect a 12-volt accessory directly to the batteries. Always connect any powered accessory to the 12-volt terminal board. See 12-Volt Terminal Board Connections section in the Features and Controls chapter.
- Never connect jumper cables to any of the batteries of this vehicle.

CAUTION

Always wear safety glasses or approved eye protection when servicing the vehicle. Wear a full-face shield and gloves when working with or around batteries and electrical connectors.

- Use only insulated tools when working in the battery compartment.
- Always keep battery terminals and connections clean and free of corrosion at all times. See Battery Inspections/Maintenance and Battery Cleaning section in the Maintenance chapter.

BRAMMO® LITHIUM-ION COLD BATTERY PERFORMANCE

- The Brammo® Lithium Ion batteries in your vehicle will not accept a charge unless internal battery temperatures are at or above 41 °F (5 °C).
- When ambient temperature is at or above -16 °F (-27 °C), the battery heaters will use battery pack energy to warm the batteries to an internal temperature of 41 °F (5 °C), at which point the batteries will accept a charge.
- The battery heaters will not operate when ambient temperature is below -16 °F (-27 °C).
- When ambient temperature is below -16 °F (-27 °C), the vehicle should remain in storage until ambient temperature is at or above -16 °F (-27 °C).

Whenever ambient temperatures could drop below freezing during storage:

- Always make sure the batteries contain at least 20% state of charge (SOC).
- Always connect the charger to make sure the batteries can support operation of the battery heaters and recharge the batteries as needed.

FEATURES AND CONTROLS

12-VOLT TERMINAL BOARD CONNECTIONS

Remove the upper dash to access the 12-volt terminal board ①. Always make sure that all 12-volt electrical accessories are grounded directly to the negative (-) post on the terminal board. Never use the chassis or body as a ground connection. Use the positive (+) terminal only for accessories that require constant power (when the ignition key is off). Use the accessory (ACC) terminal for accessories that require power only when the ignition key is on.

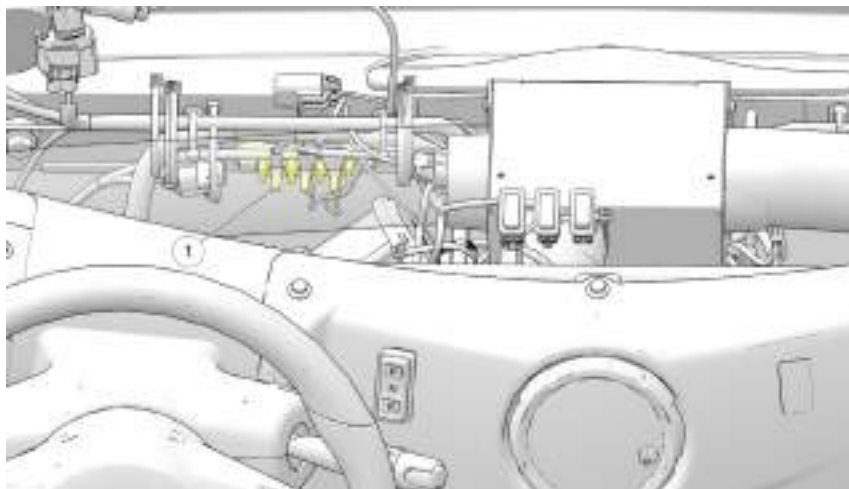

NOTICE

To avoid draining the battery system, always install an accessory exactly as stated in the provided installation instructions.

SERVICE DISCONNECT

When the service disconnect is unplugged, the power is disconnected from all electrical components, with the exception of the contactor. After servicing the vehicle, the service disconnect should be the last connection to be made.



DISCONNECTING POWER

1. Position the vehicle on a dry, firm, level surface.
2. Set the park brake.
3. Turn the key off.
4. Remove the hood, if needed. See page 50.
5. Locate the service disconnect ① at the lower left front of the vehicle, below the horn assembly. Unplug the service disconnect.
6. Locate and disconnect electrical accessory connectors (such as a heater or a heated windshield).
7. If equipped, disconnect the negative cable from the auxiliary 12-volt battery.
8. Disconnect the main NEGATIVE cable from the traction batteries. Isolate the cable end to ensure the circuit cannot be completed during service.

NOTICE

Damage to electrical connections and components will occur if they are unplugged before the service disconnect is disconnected.

WARNING

Before servicing the vehicle's electrical system, always unplug the service disconnect first, then disconnect any electrical accessory connections, then disconnect the negative cable from the 12-volt battery, then disconnect the negative terminal from the main battery pack.

WARNING

Insulate any tools used within the battery area to prevent sparks or battery explosion caused by shorting the battery terminals or wiring. Remove the batteries, or cover the exposed terminals with an insulating material.

RECONNECTING POWER

1. Reconnect the negative cable to the traction batteries. Torque the nut to 8 ft-lbs (10.8 N·m).
2. Reconnect the negative cable to the auxiliary 12-volt battery. Torque the screw to 5.5 ft-lbs (7.5 N·m).
3. Reconnect electrical accessory connectors (if equipped).
4. Reconnect the service disconnect.
5. Reinstall the hood, rear access panel, and dash.

BRAKE AND ACCELERATOR PEDALS

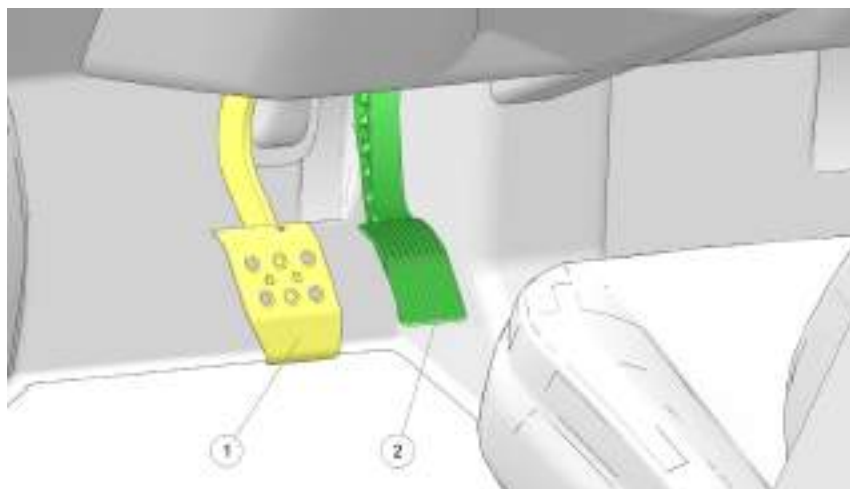

BRAKE PEDAL

The brake pedal ① is located on the floor to the left of the accelerator pedal ②. Push the brake pedal toward the floor to slow or stop the vehicle. Apply the brakes before turning the key on.

WARNING

Constant brake use (riding the brakes) can cause brakes to overheat and fail, which could lead to an accident resulting in serious injury or death. Do not drive with your foot resting or riding on the brake pedal.

ACCELERATOR PEDAL

The accelerator pedal ② is located on the floor to the right of the brake pedal. To begin moving or to increase vehicle speed, gradually push the accelerator pedal toward the floor. Holding the accelerator pedal down continuously will accelerate the vehicle to the maximum speed.

The accelerator pedal will function only if the key is on.

To slow the vehicle, release the accelerator pedal and apply the brake. The electric motor provides additional braking force when the brake pedal is applied.

PARK BRAKE LEVER

WARNING

A rolling vehicle can cause serious injury. Always set the park brake when leaving the vehicle unattended.
Remove the key from the ignition to prevent unauthorized use.

Always apply the brakes before setting or releasing the park brake. To release the park brake, press and hold the park brake release ① and move the lever to the disengaged position. To set the park brake, pull the park brake lever ② slightly upward and toward the center of the vehicle. If the key is turned off without setting the park brake, an alert will sound. Set the park brake to end the alert.



When the park brake is set and the brake indicator is illuminated, the vehicle will not move.

NOTICE

Be sure the park brake is fully disengaged before driving. Failure to do so can lead to overheating of the rear brakes.

NOTICE

The park brake is adjustable and should be checked periodically as outlined in the Periodic Maintenance Chart in the Maintenance chapter. Your authorized GEM dealer can assist.

DOME LIGHT

Turn the dome lights on or off by pressing the switch ① located on the dash between cup holders.



UNDER DASH LIGHTING (OPTION)

NOTICE

The location of under dash lighting switch in the bank of switches on the dash varies with the options installed on the vehicle.

The under dash lighting switch is located between the cup holders on the dash. The positions of the switch are:

- ① Blue Lights
- ② Off
- ③ White Lights

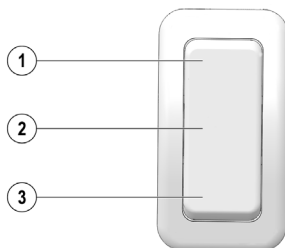

DOORS

Accessory doors are available for all models.

⚠ WARNING

Doors do not offer structural protection in the event of an accident and do not change the open body characteristics of the vehicle. The doors provide protection from the weather only. Always use seat belts. Failure to use the seat belts puts the driver and passengers at greater risk of serious injury or death in the event of an accident.

SEAT ADJUSTMENT

Seats can be adjusted forward or rearward. The seat adjustment lever ① is directly under the front of the seat.

- 1. Move the adjustment lever to the left and slide the seat to the desired position.
- 2. Release the lever.
- 3. Make sure the seat latches securely in position. Test the latch by attempting to slide the seat forward and rearward while seated.



SEAT BELTS

Riding in this vehicle without wearing the seat belt increases the risk of serious injury in the event of an accident or sudden stop. Occupants *must* wear seat belts at all times. Always make sure the seat belts are secured for operator and all passengers before operating.

WARNING

Always wear your seat belt. Ensure the seat belts are secured for operator and all passengers before operating. Failure to do so could result in the risk of serious injury or death.

PROPER SEAT BELT USE

This vehicle is equipped with three-point lap and diagonal seat belts for all occupants. Always make sure the seat belts are secured for operator and all passengers before operating.

When the key is turned on, the seat belt indicator lamp will illuminate if the driver's seat belt is not fastened. To wear the seat belt properly, follow this procedure:

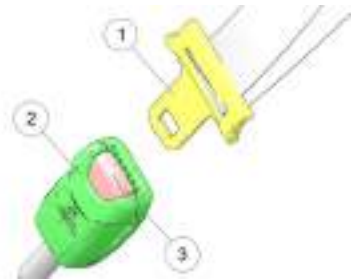

1. Pull the seat belt latch plate ① downward and across your chest toward the buckle ② at the inner edge of the seat.
2. Slide the latch plate up the webbing as far as needed for the belt to reach across your hips. The belt should fit snugly across your hips and diagonally across your chest. Make sure the belt is not twisted.
3. Push the latch plate into the buckle until it clicks.
4. Release the strap, it will self-tighten.
5. To remove slack in the lap belt portion of the belt, pull upward on the shoulder belt. To loosen the lap belt if it is too tight, tilt the buckle and pull the lap belt slightly longer.
6. To release the seat belt, press the square red button ③ in the buckle's center. If necessary, slide the buckle down the webbing to allow it to retract fully.

FEATURES AND CONTROLS

SEAT BELT SAFETY TIPS

- In a rear seat, you may have trouble tightening the lap/shoulder belt on the restraint because the buckle or latch plate is too close to the belt path opening on the restraint. Disconnect the latch plate from the buckle and twist the short buckle-end belt several times to shorten it. Insert the latch plate into the buckle with the release button facing outward.
- If the belt still cannot be tightened when using a safety seat, or if pulling and pushing on the restraint loosens the belt, disconnect the latch plate from the buckle, turn the buckle around and insert the latch plate into the buckle again. If you still cannot make the restraint secure, try a different seating position.

SEAT BELT INSPECTION

Inspect all seat belts for proper operation before each use of the vehicle.

1. Push the latch plate into the buckle until it clicks. The latch plate must slide smoothly into the buckle. A click indicates that it's securely latched.
2. Push the red release latch in the middle of the buckle to make sure it releases freely.
3. Pull each seat belt completely out and inspect the full length for any damage, including cuts, wear, fraying or stiffness. If any damage is found, or if the seat belt does not operate properly, have the seat belt system checked and/or replaced by a GEM authorized service dealer.
4. To clean dirt or debris from the seat belts, sponge the straps with mild soap and water. Do not use bleach, dye or household detergents.

STEREO SYSTEM (OPTION)

Optional stereo systems with different features are available. The stereo system ① is mounted in the middle of the dash. Refer to your stereo system's user manual for detailed operating instructions.



SOLAR PANEL (OPTION)

The optional solar panel ① is mounted on top of the vehicle. Refer to your solar panel user manual for details.

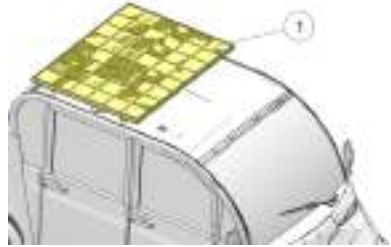

WARNING

Do not stack items on the solar panel. Never exceed the GVWR or GAWR.

REAR ACCESSORY BACKS (OPTION)

Many rear accessory options are available, a couple are shown below. Accessory backs are interchangeable.

1. Remove the contents of the installed rear accessory back.
2. Remove the attachment bolts.
3. Firmly grasp the installed back and remove it from the vehicle.

Trunkback



Cargo Carrier

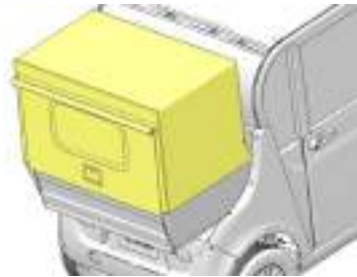

WARNING

Never carry a passenger on a rear accessory back. Do not overload an accessory back. Overloading the vehicle can reduce stability and handling and could cause loss of control. *Never exceed the GVWR or the GAWR of the vehicle.* See page 17.

FEATURES AND CONTROLS

NOTICE

Use only GEM-approved rear accessories. Others may cause damage to the locking system or vehicle, and may void warranty.

GRAB HANDLE PACKAGE (STANDARD)

Grab handles can be added at each seat position to assist riders in entering and exiting the vehicle. Interior grab handles are not intended to retain passengers in the vehicle. Always make sure the seat belts are secured for operator and all passengers before operating.

HOOD

Remove the hood to access the fuse box, windshield washer fluid tank (if equipped), service disconnect and electrical accessory connectors.

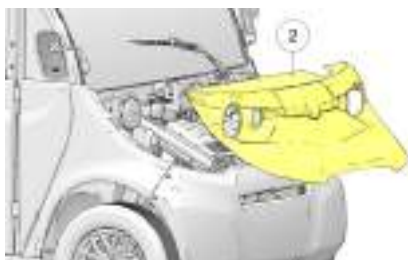
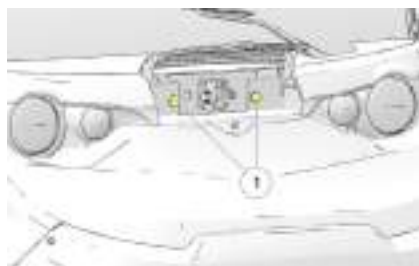

1. Remove the two hood screws ① located under the charge port door.
2. Keeping the hood ② parallel with the ground, pull the hood forward to release it from the grommets. Carefully lift the hood away from the vehicle.

PREMIUM BUMPERS/RUGGED BUMPERS (OPTION)

Front bumpers are for appearance only and will protect the body panels only from minor dents and scratches. They will not provide protection to the vehicle in front-end collisions.



NOTICE

Never use your GEM vehicle for pushing. Damage to the vehicle may result.

HEATER/FAN (OPTION)

The heater unit can be used to provide heat inside the vehicle. The switch is located on the console. Move the switch to the HEAT position. Move the switch to the FAN position to operate air flow without heat.

HEATED WINDSHIELD (OPTION)

The heated windshield has heating elements within the glass to assist in defogging the windshield.

Press the heated windshield switch on the console to turn on the heating elements. A light on the switch illuminates when the elements are heating.

Press the switch again to turn off the heating elements. If the heating elements are not turned off, they will automatically turn off after five minutes of operation.

ADJUSTABLE TILT STEERING COLUMN (OPTION)

1. Move and hold the tilt lever ① forward or rearward to release the latch.
2. Adjust the steering column to the desired position.
3. Release the lever to the center position to lock the steering column.

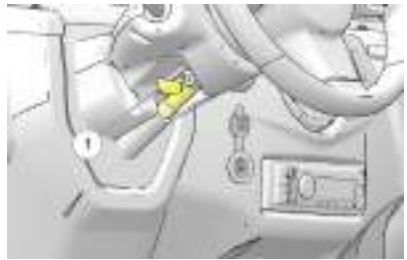

WINDSHIELD WASHER (OPTION)

Rotate the knurled barrel ① forward to turn the windshield wipers on.

Pull the control lever toward the driver's seat to activate the washer. Check the washer reservoir fluid level frequently.

When the level is low, remove the cap and add windshield solvent rated for -25°F (-31°C).



WARNING

Commercial windshield washer solvents are flammable. Keep sparks, flames and cigarettes away. Handle with caution.

OPERATION

OPERATION WARNING

 WARNING

Failure to operate the vehicle properly can result in a collision, loss of control, accident or rollover, which may result in serious injury or death. Read and understand all safety warnings outlined in the safety section of this owner's manual.

PRE-RIDE INSPECTION

 WARNING

Failure to inspect and verify that the vehicle is in safe operating condition before operating increases the risk of an accident. Always inspect the vehicle before each use to make sure it's in safe operating condition.

Item	Remarks	Page
Accelerator	Ensure proper operation	page 44
Brake system/pedal travel	Ensure proper operation	page 65
Brake fluid	Ensure proper level	page 65
Indicator lights/switches	Ensure operation	-
Headlamp	Check operation	page 75
Brake light/tail lamp	Check operation	-
Turn signals	Ensure operation of all signal lamps	page 26

OPERATION

Item	Remarks	Page
Mirrors	Adjust mirrors for proper side and rear view	-
Horn	Ensure operation	page 26
Seat belts	Check length of belt for damage, check latches for proper operation	page 47
Steering	Ensure free operation	page 35
Tires	Check tire condition and pressure	page 69
Latches (doors/seats/ accessory back)	Ensure all latches are secure	-
Batteries	Ensure full charges, proper water levels, clean terminals	
Battery cables	Inspect for proper cable routing, secure connections	page 76
Wheels/fasteners	Inspect, ensure fastener tightness	page 70

DRIVING PROCEDURE

1. Disconnect the charging cable.
2. Sit in the driver's seat and fasten the seat belt. Make sure passengers are seated with seat belts secured.
3. Adjust mirrors as needed.
4. Turn the key clockwise to the ON position.
5. Apply the brakes.
6. Release the park brake.
7. Move the direction switch to the desired position.
8. Check your surroundings and determine your path of travel.
9. Keeping both hands on the steering wheel, release the brake pedal and gradually push the accelerator toward the floor to begin driving.
10. Drive slowly. Practice maneuvering and using the accelerator and brakes on level surfaces.
11. Before turning, activate a turn signal to alert others of your intentions.
12. Do not carry a passenger until you have at least two hours of driving experience with this vehicle. Allow a passenger to ride only in a designated passenger seat with seat belt secured.
13. To stop the vehicle, release the accelerator pedal completely and brake to a complete stop.

NOTICE

Always bring the vehicle to a complete stop before changing the position of the direction switch.

14. Set the park brake.

WARNING

A rolling vehicle can cause serious injury or death. Always set the park brake when leaving the vehicle unattended.

15. Turn the key off.
16. Recharge the batteries daily, or after each use of the vehicle.

OPERATION

DRIVING IN REVERSE

Your vehicle comes with a reverse camera located on the rear-view mirror. Operation of the camera is automatic and is activated when the vehicle's drive mode switch is in the reverse position.

Follow these precautions when operating in reverse:

1. Always check for obstacles or people behind the vehicle. Always inspect left and right fields of vision before backing.
2. Avoid backing downhill.
3. Back slowly.
4. Apply the brakes *lightly* for stopping.
5. Avoid turning at sharp angles.
6. Never accelerate suddenly.

DRIVING ON SLIPPERY SURFACES

WARNING

Skidding or sliding can cause loss of control or rollover (if tires regain traction unexpectedly). When operating on slippery surfaces, reduce speed and use extra caution to reduce the chance of skidding or sliding out of control. Do not operate on excessively slippery surfaces.

Whenever driving on slippery surfaces such as wet or icy pavement or loose gravel, follow these precautions:

1. Do not operate on excessively slippery surfaces.
2. Slow down before driving onto a slippery surface.
3. Avoid quick, sharp turns, which can cause skids.
4. Correct a skid by turning the steering wheel in the direction of the skid. *Never apply the brakes during a skid.*

PARKING THE VEHICLE

1. Apply the brakes. Stop the vehicle on a level surface.
2. When parking inside a garage or other structure, be sure that the structure is well ventilated and that the vehicle is not close to any source of flame or sparks, including any appliance with pilot lights.
3. Move the direction switch to the neutral position.
4. Set the park brake.
5. Turn the key off. Remove the key from the ignition to prevent unauthorized use.

PARKING ON AN INCLINE

1. Apply the brakes.
2. Set the park brake.
3. Place the direction selector in neutral.
4. Turn the key off.

Avoid parking on an incline if possible. If it's unavoidable, follow these precautions:

- If parking in an open area, block the wheels on the downhill side of the vehicle after turning the key off.
- If parking parallel to a curb, stop the vehicle close to the curb. If the vehicle is facing downhill, turn the steering wheel toward the curb. The forward part of the front tire should be turned into the curb. If the vehicle is facing uphill, turn the steering wheel away from the curb. The rear part of the front tire should be turned into the curb.
- Set the park brake.

TOWING LOADS (EL XD)

Your vehicle has been designed to carry or tow specific capacities. Always read and understand the load distribution warnings listed on the warning labels. See Safety Labels and Location section in the Safety chapter.

The total load (operator, passenger, accessories, cargo and weight on hitch) must not exceed the maximum weight capacity of the vehicle.

OPERATION

Always follow these precautions when towing:

1. Never load more than 150 lb (68 kg) tongue weight on the towing bracket.
2. Slow down when towing. Towing a trailer increases braking distance.
3. Do not tow more than the recommended weight for the vehicle.
4. Attach a trailer to the trailer hitch bracket only. Do not attach a trailer to any other location on the vehicle.

TRANSPORTING THE VEHICLE

LOADING AND UNLOADING

The weight distribution of the cargo loaded onto the trailer is important and will have an impact on how the vehicle handles on the road. Ensure the weight of the cargo is distributed properly and the trailer is not rear, front, or side heavy.

Always use a spotter if you are uncomfortable loading the vehicle on your own. A wheel chock or marker can also be used as an indication of how close you will park the vehicle from the front of the trailer.

WARNING

When loading or unloading a vehicle onto a trailer, always wear the appropriate safety gear.

MINIMUM WORKING LOAD LIMIT

WARNING

Always secure cargo properly. Improperly securing a load can result in severe injury or death.

Securing devices, such as tie-down straps, are manufactured to support a load that can be applied during normal service. This is known as the Working Load Limit (WLL).

VEHICLE TYPE	TIE-DOWN MINIMUM WLL
All Vehicles	3,300 lb (1497 kg)

TRANSPORTING THE VEHICLE

Follow these procedures when transporting the vehicle.

NOTICE

Do not tow your GEM vehicle behind a car or other vehicle except on a trailer. Vehicle failures resulting from dolly towing will void warranty.

1. Properly load the vehicle onto the trailer or towing vehicle.
2. Apply the park brake.
3. Turn the key off and remove to prevent loss during transporting.
4. Ensure that all seats are attached correctly and are not loose.
5. Secure the vehicle and rear accessory back doors (if equipped).

WARNING

Cargo and other loose vehicle parts may fall off while transporting the vehicle. Secure or remove all cargo, and inspect the unit for loose parts prior to transport.

WARNING

Do not exceed the towing vehicle's or trailer's capacity when transporting. Refer to the towing vehicle and trailer's specifications.

WARNING

If transporting the vehicle in a non-enclosed trailer, the vehicle must FACE FORWARD. Failure to comply may allow airflow, vibration, or other factors to separate the roof from the vehicle and cause an accident, resulting in serious personal injury or death.

WARNING

If transporting the vehicle in a non-enclosed trailer and the vehicle is equipped with hard doors, put all windows down.

OPERATION

- Using tie-down straps of suitable Working Load Limit (WLL), secure the vehicle to the trailer at the designated tie-down points (front and rear). The straps must be secured in a manner that provides support in both vertical and lateral directions. Ensure that they are set with enough tension as to compress the suspension and prevent vehicle movement during transport. Do not allow the secured straps to make contact with any other part of the trailer or cargo.

 CAUTION

Always use the provided tie-down points. Not using the provided vehicle tie-down points could lead to premature component failure and/or excess wear on the tie-down straps.

 WARNING

Always secure the vehicle with at least four straps when trailering. Use two straps in the front, and two in the rear.

 WARNING

Never use chains to tie down the vehicle.

 WARNING

Never place tie straps across any plastic body or floor panel components.

 WARNING

Do not lay straps over any sharp edges. Sharp edges may damage straps during transportation.

- Periodically inspect the vehicle and trailer during transit. Adjust cargo and straps as needed to ensure that the cargo cannot shift, or fall from the trailer or towing vehicle.

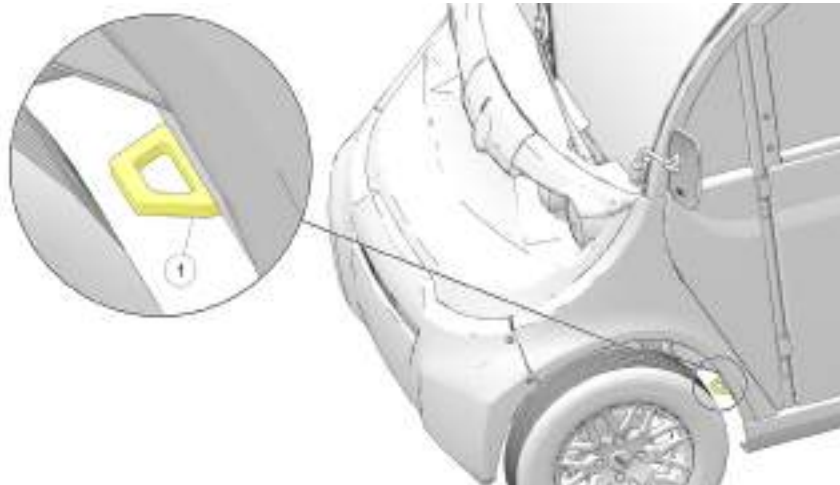
TIE-DOWN LOCATIONS

① Front tie-down point

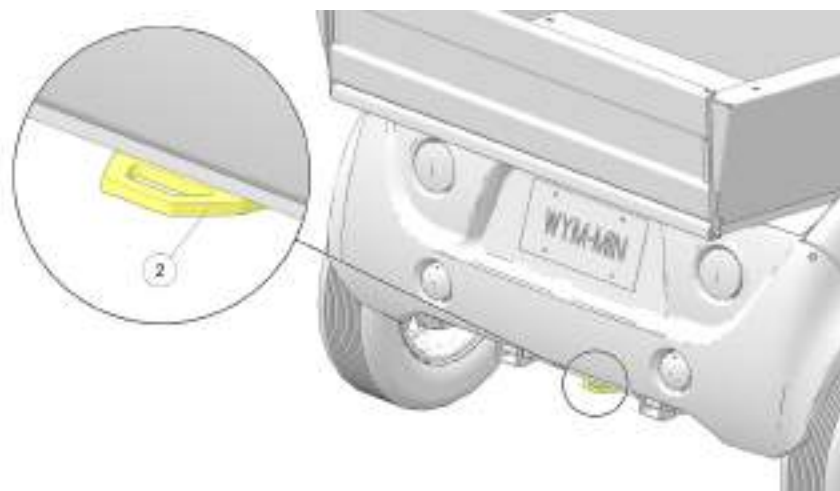

② Rear tie-down points

MAINTENANCE

PERIODIC MAINTENANCE CHART

 **WARNING**

Always wear safety glasses or approved eye protection when servicing the vehicle. Wear a full-face shield and gloves when working with or around batteries and electrical connectors. Always use insulated tools when working with or near batteries. Failure to follow these instructions could result in serious injury or death.

NOTICE

Damage to electrical connections and components will occur if they are unplugged before the service disconnect is unplugged.

 **WARNING**

Before servicing the vehicle's electrical system, always unplug the service disconnect first, then disconnect any electrical accessory connections, then disconnect the negative cable from the 12-volt battery, then disconnect the negative terminal from the main battery pack. See Service Disconnect in the Features and Controls chapter.

Careful periodic maintenance will help keep your vehicle in the safest, most reliable condition. Inspect, clean, lubricate, adjust and replace parts as necessary. When inspection reveals the need for replacement parts, genuine GEM parts are available from your authorized GEM dealer.

Record maintenance and service in the Maintenance Log at the back of the book.

NOTICE

Service and adjustments are important for proper vehicle operation. If you're not familiar with safe service and adjustment procedures, your authorized GEM dealer can perform these operations..

MONTHLY MAINTENANCE	SEE
Check cables and terminal connections.	page 77
Check for worn insulation or frayed wires.	page 77

MAINTENANCE

MONTHLY MAINTENANCE	SEE
Check battery hold-down bar to ensure batteries are tightly secured.	page 77
Check tires for correct air pressure and wear.	page 69
Check wheels for proper torque after first 100 miles (160 km) driven, and after first 100 miles (160 km) after any wheel if removed.	page 72
Rotate wheels every 5000 miles (8000 km), or more frequently if needed.	page 70
Check brake fluid reservoir for proper brake fluid level.	page 65
Check brake lines for leaks.	-
Check seat belts for proper operation.	page 48
Check headlights, horn, turn signals, windshield wiper and brake lights for proper operation.	-
Check steering wheel freeplay.	page 64

STEERING WHEEL INSPECTION

Check the steering wheel for specified freeplay and smooth operation at the intervals outlined in the Periodic Maintenance Chart.

1. Position the vehicle on a level surface.
2. Lightly turn the steering wheel left and right. There should be 0.8-1.0 in (20-25 mm) of freeplay at the outer rim of the steering wheel.
3. If there is excessive freeplay or strange noises, or the steering feels rough or "catchy," have the steering system inspected by an authorized GEM service dealer.

BRAKES

BRAKE INSPECTION

1. Check the brake system for fluid leaks.
2. Check the brake pedal for excessive travel or a spongy feel.
3. Check the friction pads for wear, damage and looseness.
4. Inspect the brake disc spline and pad wear surface for excessive wear.
5. Change pads when worn to 0.030 in (0.762 mm) ①.



BRAKE FLUID

Inspect the brake system routinely. Inspect the brake fluid level before each operation. If the level drops between fluid checks, add brake fluid as needed. Your authorized GEM dealer can provide service.

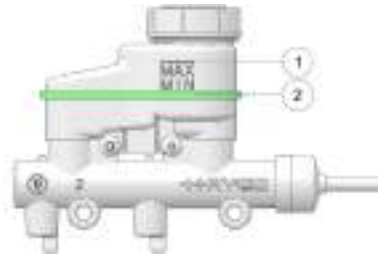

1. Position the vehicle on a level surface.
2. Open the hood. The brake fluid reservoir is located on the driver's side of the vehicle, above and to the rear of the front tire.
3. View the brake fluid level in the reservoir. The level should be between the upper (MAX) ① and lower (MIN) ② level lines.
4. If the fluid level is lower than the upper level line, add brake fluid to the upper (MAX) line.
5. Apply the brake forcefully for the few seconds and check for fluid leakage around the fittings.

Change the brake fluid every two years and any time the fluid becomes contaminated, the fluid level is below the minimum, or if the type and brand of the fluid in the reservoir are unknown. Always use DOT4 brake fluid.

MAINTENANCE

WARNING

After opening a bottle of brake fluid, always discard any unused portion. Never store or use a partial bottle. Brake fluid is hygroscopic, meaning it rapidly absorbs moisture from the air. The moisture causes the boiling temperature of the brake fluid to drop, which can lead to early brake fade and the possibility of accident or severe injury.

NOTICE

Brake fluid may cause damage to painted and finished surfaces. Use caution when refilling the brake fluid reservoir.

UPPER DASH REMOVAL/INSTALLATION

Some maintenance procedures require removal of the upper dash to access components.



1. Remove the eight (8) plastic push rivets ① securing the dash to the frame. Two of the rivets are located inside the glove box.
2. Slightly raise the dash and unplug any switch connections located between the cup holders.
3. Carefully remove the dash from the vehicle.
4. Reverse this procedure to reinstall the dash.

FUSES AND RELAYS

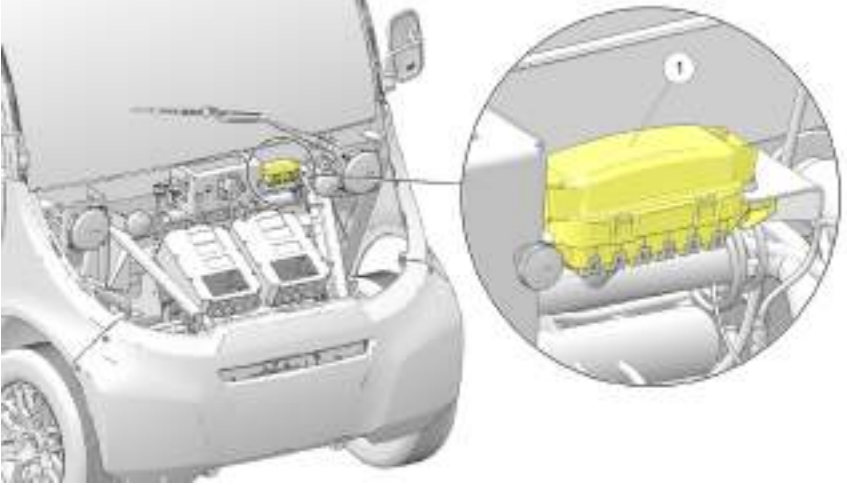

If you experience electrical failures not related to the batteries, a fuse may need replacement. Locate and correct any short circuits that may have caused the blown fuse, then replace the fuse. If you suspect a relay or diode needs replacement, your authorized GEM dealer can assist.

Open the hood to access the fuse box ① . See the label attached to the fuse box cover for the function and amp rating of each fuse.

MOTOR CONTROL RELAY	DISPLAY RELAY	CHASSIS RELAY	VCM RELAY	DC/DC RELAY	
BACKUP RELAY (OPT)	HORN 10A	DRIVE 5A	CHASSIS 30A	VCM 20A	CON- STANT 5A
	INT. LIGHT 5A	WIPER 15A	ACC 15A	DISPLAY 10A	LIGHTS 15A

MAINTENANCE

WARNING

Before servicing the vehicle's electrical system, always unplug the service disconnect first, then disconnect any electrical accessory connections, then disconnect the negative cable from the 12-volt battery, then disconnect the negative terminal from the main battery pack. See Service Disconnect section in the Features and Control Chapter.

FUSE AND RELAY RECOMMENDATIONS

STANDARD 12V FUSES		
APPLICATION	SIZE	LOCATION
Drive; Constant; Internal Lighting	5 amp	12V Fuse Center
Horn; Display	10 amp	12V Fuse Center
Wiper; ACC; Lights	15 amp	12V Fuse Center
VCM	20 amp	12V Fuse Center
Chassis	30 amp	12V Fuse Center
Battery Fuse	30 amp	Near the 12V Battery

OPTIONAL 12V FUSES		
APPLICATION	SIZE	LOCATION
Lithium-ion	5 amp	Lithium-ion Harness
Beacon Light	7.5 amp	Beacon Harness
Security Light	7.5 amp	Security Light Harness
Stereo	10 amp	Stereo Harness
Under Dash Lighting	10 amp	Under Dash Light Harness
EPS	30 amp	EPS Harness

STANDARD 48V FUSES		
APPLICATION	SIZE	LOCATION
Motor Controller/ BMC	5 amp	48V Fuse Center
DC-DC	15 amp	48V Fuse Center
Charger	30 amp	48V Fuse Center

OPTIONAL 48V FUSES		
APPLICATION	SIZE	LOCATION
Lithium-ion	5 amp	Lithium-ion Harness
Heater Heating Element	30 amp	Heater Harness
Defrost	30 amp	Defrost Harness

NOTICE

12V fuses must not be used in 48V applications. 48V fuses must not be used in 12V applications. Always install fuses with the recommended amperage to avoid damage to the electrical system.

TIRES

WARNING

Operating your vehicle with worn tires, improperly inflated tires, non-standard tires or improperly installed tires will affect vehicle handling and could cause an accident resulting in serious injury or death. Always follow all tire maintenance procedures as outlined in this manual and on the labels on the vehicle. Always use original equipment size and type when replacing tires.

TIRE PRESSURE

WARNING

Improper tire pressure can cause loss of control resulting in severe injury or death.

MAINTENANCE

Proper tire pressure is essential to the safe and comfortable operation of your vehicle. Check tire pressure daily, or before each use of the vehicle. For recommended tire pressures, see the manufacturer's label on your vehicle or the specifications section.

NOTICE

After inspecting or adjusting the tire pressure, always reinstall the valve stem cap (if equipped). This will prevent moisture and dirt from entering the valve stem, which could cause damage.

TIRE TREAD DEPTH

Any accelerated wear of tires may be an indicator of improper alignment or poor driving habits. Your authorized GEM dealer can assist.

Rotate wheels every 5000 miles (8000 km), or more frequently if needed.

Always replace tires when tread depth is worn to 1/8 in (3 mm) or less. ①

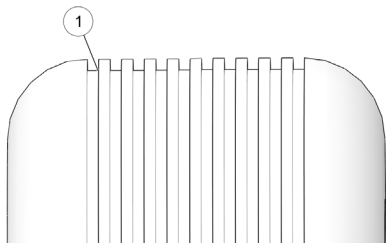

WHEEL NUT TORQUE



Inspect the following items occasionally for tightness, and if they've been loosened for maintenance service. Do not lubricate the stud, the lug nut, or the washers (washers equipped on vehicles with factory steel wheels).

Check wheels for proper torque after first 100 miles (160 km) driven and the first 100 miles (160 km) after any wheel is removed.

- ① 13 inch Steel wheels: 50 ft-lbs (67.8 N·m)
- ② 14 inch Cast Aluminum wheels: 63 ft-lbs (85.4 N·m)
- ③ 16 inch Cast Aluminum wheels: 63 ft-lbs (85.4 N·m)

WHEEL REMOVAL

WARNING

A falling vehicle can cause serious injury or death. Never place any part of your body under an elevated vehicle. If you need access to the bottom of the vehicle, use automotive jack stands to support the vehicle on a firm, level surface. Your authorized GEM dealer can assist.

1. Position the vehicle on a dry, firm, level surface.
2. Set the park brake.
3. Turn the key off.
4. Block both the front and rear of the tire that is located diagonally opposite the jacking position. For example, if the right front tire is being changed, block the left rear wheel.
5. Use a small floor style jack or low profile scissors jack only. Jack the vehicle only from the side of the vehicle, on the main frame rail, at the point where the tub or floor panel support and the main frame rail are welded . Alternative locations include the rear frame rail and the center of the front cross member.
6. Remove the wheel nuts and cone washers (for vehicles with factory steel wheels).
7. Remove the wheel.

NOTICE

Jacking at any location other than the recommended jacking points may cause significant damage to the vehicle frame and body.

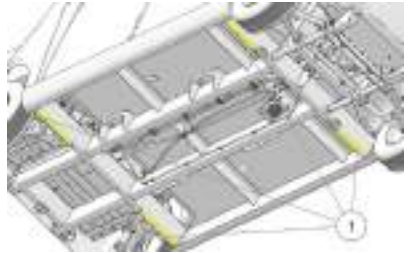

MAINTENANCE

WHEEL INSTALLATION

WARNING

Improperly installed wheels can adversely affect tire wear and vehicle handling, which can result in serious injury or death. Always ensure that all nuts are torqued to specification. Do not service axle nuts that have a cotter pin installed. Your authorized GEM dealer can provide service.

NOTICE

To ensure that the washers fully seat in the wheel taper, use other hand to position and center wheel, if necessary.

1. Set the park brake.
2. Place the wheel in the correct position on the wheel hub. Be sure the valve stem is toward the outside and rotation arrows on the tire point toward forward rotation.
3. Attach the wheel nuts and finger tighten. For vehicles with steel wheels, install cone washers then install new lug nuts. With hand tools, lightly tighten the nuts.
4. Carefully lower the vehicle to the ground.
5. Torque the wheel nuts to specification in the same criss-cross pattern as shown.





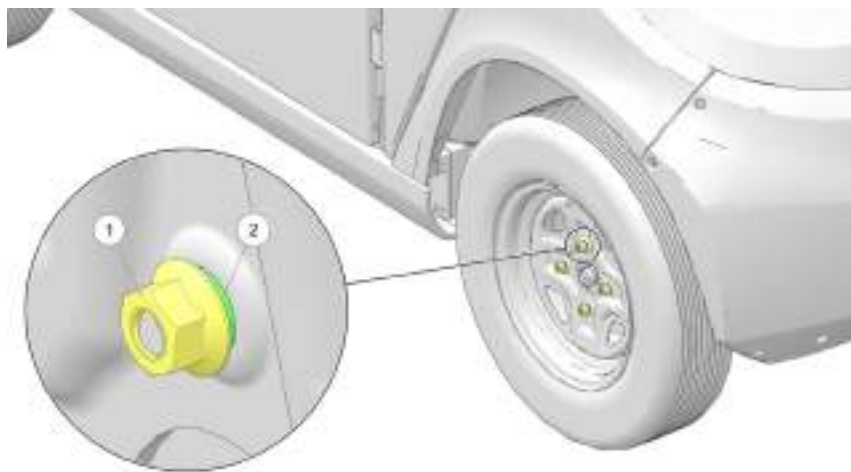

STEEL WHEEL HUB INSPECTION

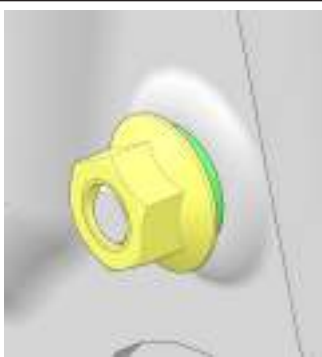

① Flange Nut

② Cone Washer

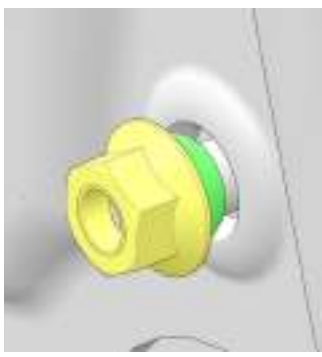
MAINTENANCE

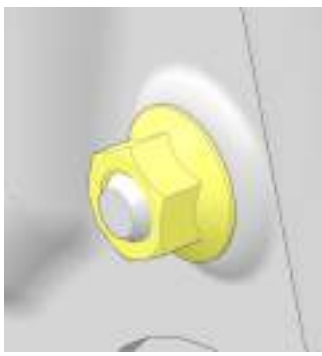
CORRECT	Flange nuts are tight and only in contact with the cone washers.		
INCORRECT	Flange nuts and cone washers are loose. The wheel is not secure.		
INCORRECT	Flange nuts are contacting the rim. Flange nuts and cone washers are over tightened.		

LIGHTS

Poor lighting can result in reduced visibility when driving. Headlight and taillight lenses become dirty during normal operation. Clean lights frequently and replace burned out lamps promptly. Do not operate this vehicle at night or in low light conditions until the headlight is replaced. Always make sure lights are adjusted properly for best visibility.

HEADLIGHT, TURN SIGNAL, AND BRAKE LIGHT REPLACEMENT

If an LED light fails to work properly, the entire assembly must be replaced. Your authorized GEM dealer can provide service.

HEADLIGHT BEAM ADJUSTMENT

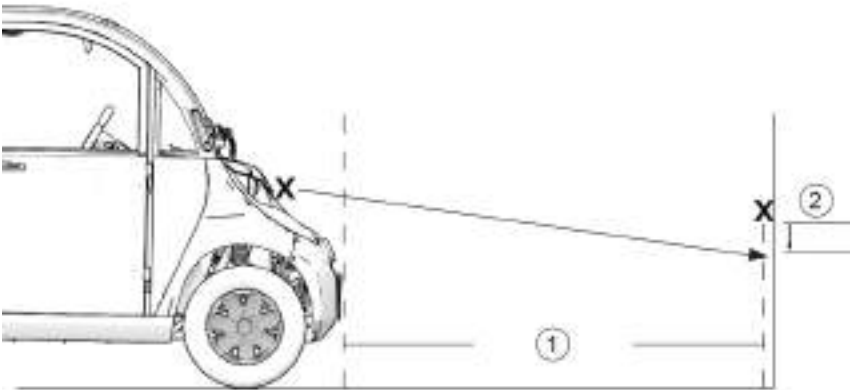

1. Place the vehicle on a level surface with the headlight approximately 25 ft (7.6 m) from a wall ①.
2. Measure the distance from the floor to the center of the headlight and make a mark on the wall at the same height.
3. Apply the brakes. Turn the key on. Turn the headlights on.
4. Observe the headlight aim. The most intense part of the headlight beam should be aimed 8 in (20 cm) below the mark placed on the wall ②. Include the weight of a rider on the seat while performing this step.
5. If a headlight needs adjustment, access the adjustment screw under the hood or through the wheel well.
6. Loosen the headlight adjustment screw, adjust the headlight, and tighten the screw.
7. Repeat steps 4-6 until the lamp is properly adjusted.

BATTERIES

DANGER

The voltage in the battery pack is sufficient to cause death by electrocution. With the exception of battery inspections, never attempt to perform service on the electric drive system, including the battery pack, unless you are properly trained to work on electrical systems. Your authorized GEM dealer can provide battery-related service.

WARNING

Battery posts, terminals and related components contain lead and lead compounds, chemicals known to cause cancer and reproductive harm. Always wash your hands after touching or handling the batteries.

WARNING

Charging a damaged battery can result in serious injury. Never attempt to charge a frozen or bulging battery. Discard the battery appropriately and install a new battery.

WARNING

Battery electrolyte is poisonous. It contains sulfuric acid. Serious burns can result from contact with skin, eyes or clothing.

Antidote:

External: Flush with water.

Internal: Drink large quantities of water or milk. Follow with milk of magnesia, beaten egg, or vegetable oil. Call physician immediately.

Eyes: Flush with water for 15 minutes and get prompt medical attention.

Batteries produce explosive gases. Keep sparks, flame, cigarettes, etc. away.

Ventilate when charging or using in an enclosed space. Always shield eyes when working near batteries. KEEP OUT OF REACH OF CHILDREN.

TRACTION BATTERY CONFIGURATIONS

NOTICE

Before accessing the batteries, make sure any wire or metal items remain clear of the battery compartment to avoid causing a short circuit to the electrical system.

Several battery pack configurations exist for GEM vehicles.

- Four 12-volt lead acid batteries
- Eight 6-volt lead acid batteries
- Single module lithium ion battery pack
- Dual module lithium ion battery pack

TRACTION BATTERY LOCATIONS

To access the battery pack, remove any rear accessory back installed on the vehicle. See page 50. Release the battery pack access cover fasteners and remove the cover.

ALL BATTERY CONFIGURATIONS	
MODEL	LOCATION
GEM e2	Under rear compartment
GEM e4	Under rear compartment
GEM e6	Under rear compartment
GEM e1 XD	Under rear bed compartment

BATTERY INSPECTIONS/MAINTENANCE

WARNING

Do not work in or near the battery compartment or on any other electrical component of the vehicle while charging the batteries. Before servicing the vehicle's electrical system, always unplug the service disconnect first, then disconnect any electrical accessory connections, then disconnect the negative cable from the 12-volt battery, then disconnect the negative terminal from the main battery pack. This will disable the vehicle by disconnecting the battery pack from the motor. It does not disable the battery pack. HIGH VOLTAGE will be present at the battery terminals. HIGH BATTERY VOLTAGE IS ALWAYS PRESENT. DO NOT TOUCH THE BATTERY TERMINALS.

MAINTENANCE

CHECK BATTERY CONNECTIONS

WARNING

Improper handling of high voltage wiring, batteries or control systems could result in serious injury or death by electric shock. Only qualified GEM technicians should repair or access high voltage wiring, battery packs and associated systems.

Inspect and clean battery terminal connections monthly. Carefully remove corrosion with a stiff wire brush. Coat battery terminals with dielectric grease or petroleum jelly. Using an insulated wrench, torque bolts to 8 ft-lbs (10.8 N·m).

CHECK BATTERY CABLES AND WIRING

Check the battery compartment for any signs of worn insulation, frayed cables or damaged cable ends. If found, see your authorized GEM dealer or other qualified service person for service before operating.

WARNING

If battery cable ends are damaged or corroded, they should be replaced or cleaned as necessary. Failure to do so may cause them to overheat during operation, possibly leading to fire, which may result in serious injury or death.

CHECK BATTERY HOLD-DOWN BARS

Battery hold-down bars should be snug to keep batteries from moving while the vehicle is in motion, but not so tight as to crack or buckle the battery case. Torque fasteners to 9.5 ft-lbs (13 N·m).

BATTERY REPLACEMENT

WARNING

Handling batteries and electrical components improperly can result in serious injury or death. Do not attempt to remove batteries or battery cables. Battery posts are identified on the battery case as positive (+) and negative (-). Your authorized GEM dealer can provide battery-related service.

With proper care and maintenance, as outlined in this owner's manual, battery life can be maximized, but the battery will eventually reach the end of its useful life. When battery replacement is necessary, your authorized GEM dealer can provide this service.

NOTICE

Always install batteries of the exact type and make originally supplied with the vehicle to prevent damage to the vehicle's electrical system.

BATTERY CARE DURING STORAGE

When the vehicle will not be used for a period of 10 days or longer, perform one of the battery storage procedures listed in the chart below.

NOTICE
<p>If ambient temperatures could drop below freezing during the storage of a vehicle equipped with lithium-ion batteries, refer to the cold battery performance information beginning on page 41.</p>

BATTERY STORAGE OPTIONS	
STORAGE PERIOD	CHARGING PROCEDURE
Less than 10 days	Fully charge the batteries, park the vehicle and turn the ignition key off. The battery will lose some of its charge during this period.
10 days to 24 weeks	Leave the charger connected. See Batteries section in Features and Control chapter.
Indefinitely to Unknown	Disconnect the charger and arrange for monthly charging.

AUXILIARY BATTERY STORAGE

Your vehicle is equipped with an auxiliary battery under the dash. When the main battery is connected to a charger, the auxiliary battery is charged along with the main battery. During long-term storage (24 weeks or longer) when the main battery is not connected to a charger, the auxiliary battery must be trickle charged. If the vehicle does not operate upon removal from storage, be sure to check the auxiliary battery voltage first.

BATTERY CLEANING

1. Remove corrosion with a stiff wire brush.
2. Wash the terminals and tops of the batteries with a solution of one tablespoon baking soda and one cup water. Rinse well with tap water and dry off with clean shop towels.
3. Make sure battery terminals are tight. Use an insulated wrench to tighten as needed.
4. Allow battery terminals to dry, then coat the terminals with dielectric grease or petroleum jelly, or spray them with battery anti-corrosion spray.

CLEANING AND STORAGE

CLEANING WINDSHIELDS, WINDOWS AND SOLAR PANELS

Use a liquid household glass cleaner to remove normal dust and dirt. To remove oil, grease or road tar, use isopropyl alcohol, then wash these surfaces with water. Dry gently with a soft cloth or chamois.

NOTICE

Be very careful when cleaning acrylic surfaces as they can be scratched or damaged. Do not use a cleaner with an abrasive, a combination cleaner and wax or any solvent that contains ethyl or methyl alcohol. Do not use products containing ammonia, soaps, or abrasives. Never use gasoline or cleaning solvent. These products scratch or destroy acrylic surfaces.

CLEANING SEATS

WARNING

Do not allow excess water to pool in the seams or anywhere else on the seat.
Do not use harsh chemicals.
Do not use abrasives to remove dirt or debris.

Using a circular motion, remove excess dirt from seats with a clean, damp cloth and warm water. Substances such as tar, asphalt and other soils will stain if not removed quickly. Use a clean cloth and solvent type vinyl cleaner, then wash the area thoroughly with a damp cloth and mild liquid detergent. Rinse with cool water. Towel dry any remaining water.

CLEANING THE INTERIOR

Use mild liquid detergent and warm water to clean the interior. Remove detergent or deposits with a clean, damp cloth.

NOTICE

Do not spray the interior of your vehicle. Liquids can damage electrical components. Handle liquids with care. Do not spray water directly into the upper or lower console.
Do not use high-pressure water on seats or any interior components.

STORAGE TIPS

CLEAN THE EXTERIOR

Make any necessary repairs and clean the vehicle as recommended.

CHECK FLUID LEVELS

Inspect the fluid levels. Add or change fluids as recommended. Change brake fluid every two years and any time the fluid looks dark or contaminated.

STORING THE VEHICLE

Any time the vehicle will be parked for more than 10 days, follow the recommended storage procedures:

1. Make any necessary repairs and clean the vehicle. See page 80.
2. Clean and prepare batteries for storage. See Battery section for more instruction.

NOTICE

Batteries can be permanently damaged (and the warranty voided) if allowed to remain in a low state of charge. Fully charge batteries before storing. In hot climates, battery self-discharge will increase. In cold climates, batteries could freeze if not properly charged.

3. Store the vehicle out of the sun in a cool, dry place.
4. Be sure the storage area is well ventilated.
5. Turn the key off.
6. Verify that tire pressure is at specification.
7. Block the wheels to prevent rolling.

WARNING

Do not cover the vehicle while the charger is connected. Dangerous levels of hydrogen gas could accumulate.

8. If the vehicle is not connected to the charger, unplug the service disconnect first, then disconnect any electrical accessory connections. Next, remove the upper dashboard to access the 12-volt auxiliary battery and disconnect its negative cable. Cover the vehicle with a genuine GEM vehicle cover. Do not use plastic or coated materials. They do not allow enough ventilation to prevent condensation, and may promote corrosion and oxidation.

SPECIFICATIONS

SPECIFICATIONS

	GEM E2	GEM E4
DIMENSIONS		
Dry Weight	1200 lb (544 kg)	1350 lb (612 kg)
Length	103 in (262 cm)	135 in (343 cm) Width
Width	55.5 in (141 cm)	55.5 in (141 cm)
Height	73 in (185 cm)	73 in (185 cm)
Wheelbase	69 in (175 cm)	101 in (257 cm)
Turning Circle/Radius	150 in (381 cm)	207 in (526 cm)

LOAD CAPACITY		
Payload Capacity (occupants, cargo, options)	799 lb (363 kg)	1149 lb (521 kg)
Gross Vehicle Weight Rating (GVWR)	1999 lb (906.7 kg)	2499 lb (1133.5 kg)
Gross Axle Weight Rating (GAWR), Front and Rear	1280 lb (581 kg)	1600 lb (726 kg)
Seating	2	4

PERFORMANCE	
Motor	5 kW (optional 6.5 kW) AC electric
Motor peak	13.3 kW (optional 18.5 kW)
Controller	Sevcon 450A AC Controller
Maximum speed	25 mph (40 km/h)
Range	Varies with conditions
Drive System	17.05:1 Single speed
On-board charger	Standard 1 kW, 120/240V input (optional 3 kW or 6 kW, SAE J1772)

SPECIFICATIONS

BRAKE SYSTEM	
Brakes	4-Wheel hydraulic brakes, disc front, drum rear
Park Brake	Dash-mounted lever-activated mechanical park brake
Front suspension	MacPherson® Strut
Rear suspension	Independent w/coil over shock
Tires	13 in. Rim: 155/80R13 14 in. Rim: 165/70R14 16 in. Rim: 195/45R16
Tire pressure	35 psi (241 kPa)

	GEM EL XD	GEM E6
DIMENSIONS		
Dry Weight	1585 lb (720 kg)	1696 lb (769 kg)
Length	145.5 in (370 cm)	167 in (424 cm)
Width	55.5 in (141 cm)	55.5 in (141 cm)
Height	73.1 in (186 cm)	73.1 in (186 cm)
Wheelbase	114 in (289.6 cm)	133.5 in (339 cm)
Turning Circle/Radius	233 in (592 cm)	264 in (671 cm)

LOAD CAPACITY		
Payload Capacity (occupants, cargo, options)	1414 lb (641 kg)	1303 lb (591 kg)
Gross Vehicle Weight Rating (GVWR)	2999 lb (1360.3 kg)	2999 lb (1360.3 kg)
Gross Axle Weight Rating (GAWR), Front and Rear	1920 lb (871 kg)	1920 lb (871 kg)
Maximum Trailer Tongue Weight	150 lb (68 kg)	-
Maximum Gross Trailer Weight	1100 lb (499 kg)	-
Seating	2	6

PERFORMANCE	
Motor	6.5 kW AC electric
Motor peak	18.5 kW

SPECIFICATIONS

PERFORMANCE	
Controller	Sevcon 450AAC Controller
Maximum speed	25 mph (40 km/h)
Range	Varies with conditions
Drive System	17.05:1 Single speed
On-board charger	Standard 1 kW, 120/240V input (optional 3 kW or 6 kW, SAE J1772)

BRAKE SYSTEM	
Brakes	4-Wheel hydraulic brakes, disc front, drum rear
Park Brake	Console-mounted lever-activated mechanical park brake
Front suspension	MacPherson® Strut
Rear suspension	Independent w/coil over shock
Tires	13 in. Rim: 155/80R13 14 in. Rim: 165/70R14 16 in. Rim: 195/45R16
Tire pressure	35 psi (241 kPa)

WARRANTY

LIMITED WARRANTY

GEM WAEV LLC, 2114 Ball Road, Anaheim, CA 92804, gives a TWO-YEAR/8,000 miles (12,900 km), whichever comes first, LIMITED WARRANTY on all components (except batteries) of your GEM vehicle against defects in material or workmanship. Mileage is unlimited for the first 6 months of the vehicle warranty. Any time after month 6, the vehicle warranty expires at 8,000 miles (12,900 km) or at the end of the two-year period, whichever comes first. This warranty covers the parts and labor charges for repair or replacement of defective parts and begins on the date of purchase by the original retail purchaser. This warranty is transferable to another consumer during the warranty period through a GEM dealer, but any such transfer will not extend the original term of either warranty. The duration of this warranty and/or the battery warranty may vary by international region based upon local laws and regulations.

LEAD ACID BATTERY PACK LIMITED WARRANTY

Battery coverage in this Limited Warranty begins on the date of purchase by the original retail purchaser and continues for twenty-four months or 8,000 miles (12,900 km), whichever comes first. Mileage is unlimited for the first 6 months of the battery warranty. Any time after month 6, the battery warranty expires at 8,000 miles (12,900 km) or at the end of the two-year period, whichever comes first. During this time period, GEM WAEV LLC warrants your vehicle's batteries against defects in materials or workmanship. After the first six months in service, a defective battery will be replaced on a manufacturer/customer shared basis provided that the warranty limit of 8,000 miles (12,900 km) has not yet occurred. Review the table below for guidelines.

TERM FOR VEHICLES WITH LESS THAN 8,000 MILES (12,900 KM)	WARRANTY COVERAGE FOR LEAD ACID BATTERIES DEEMED DEFECTIVE BY GEM
Purchase Date - 6th Month of Service	100% of the cost of an approved GEM battery at a GEM dealer
7th - 12th Month of Service	75% of the cost of an approved GEM battery at a GEM dealer
13th - 18th Month of Service	50% of the cost of an approved GEM battery at a GEM dealer
19th - 24th Month of Service	25% of the cost of an approved GEM battery at a GEM dealer

WARRANTY

LI-ION BATTERY LIMITED WARRANTY

GEM WAEV LLC gives a FIVE-YEAR/30,000 miles (48,300 km) LIMITED parts and labor warranty on the battery pack against defects in material or workmanship on your GEM vehicle. The FIVE-YEAR/30,000 miles (48,300 km) term begins on the purchase date, is fully transferable and has no deductible. The term ends 5 years after purchase, or after 30,000 miles (48,300 km), whichever occurs first.

All batteries experience some reduction in capacity/range over time. A capacity/range reduction of 30% or less during the battery warranty period does not constitute a defect. Any capacity/range reduction-based claim must be confirmed by an authorized GEM dealer and approved by GEM WAEV LLC to be eligible for coverage. In addition to the WARRANTY COVERAGE EXCLUSIONS listed below, the battery warranty also excludes failure, damage or capacity loss to the batteries caused by neglect, lack of charging or not following the recommended maintenance schedule outlined in the Owner's Manual. This Li-ion battery warranty is limited to the Li-ion batteries themselves, and does not include the other Li-ion system components.

REGISTRATION

At the time of sale, the Warranty Registration Form must be completed by your dealer and submitted to GEM WAEV LLC within three days. Upon receipt of this registration, GEM WAEV LLC will record the registration for warranty. No verification of registration will be sent to the purchaser as the copy of the Warranty Registration Form will be the warranty entitlement. If you have not signed the original registration and received the customer copy, please contact your dealer immediately. **NO WARRANTY COVERAGE WILL BE ALLOWED UNLESS YOUR VEHICLE IS REGISTERED WITH GEM WAEV LLC.** Initial dealer preparation and set-up of your vehicle is very important in ensuring trouble-free operation. Purchasing a vehicle in the crate or without proper dealer set-up will void your warranty coverage.

WARRANTY COVERAGE AND EXCLUSIONS FOR LIMITED WARRANTY AND BATTERY PACK WARRANTY

LIMITATIONS OF WARRANTIES AND REMEDIES

This GEM WAEV LLC limited warranty excludes any failures that are not caused by a defect in material or workmanship. THIS WARRANTY DOES NOT COVER CLAIMS OF DEFECTIVE DESIGN. This warranty also does not cover acts of God, accidental damage, normal wear and tear, abuse or improper handling. This warranty also does not cover any vehicle, component, or part that has been altered structurally, modified, neglected, improperly maintained or used for racing, competition or purposes other than for which it was designed, or for any damages which occur during trailer transit or as a result of unauthorized service or the use of unauthorized parts.

This warranty excludes damages or failures resulting from improper lubrication; corrosion; improper engine timing; improper fuel; surface imperfections caused by external stress, heat, cold or contamination; operator error or abuse; improper component alignment, tension, adjustment or altitude compensation; snow, water, dirt or other foreign substance ingestion/contamination; improper maintenance; modified components; use of aftermarket or unapproved components, accessories, or attachments; use of unapproved software or calibration; unauthorized repairs; or repairs made after the warranty period expires or by an unauthorized repair center.

This warranty excludes damages or failures caused by abuse, accident, fire, explosion, or any other cause other than a defect in materials or workmanship and provides no coverage for consumable components, general wear items, or any parts exposed to friction surfaces, stresses, environmental conditions and/or contamination for which they were not designed or not intended, including but not limited to the following items:

- Wheels and tires
- Suspension components
- Brake components
- Seat components
- Steering components
- Bushings/Bearings
- Finished and unfinished surfaces
- Upholstery
- Lubricants
- Sealants
- Circuit breakers/Fuses
- Light bulbs/Sealed beam lamps

WARRANTY

The battery coverage included in this warranty provides no coverage for:

- Batteries that fail due to lack of battery maintenance, over-charging, under-charging, abuse or neglect
- Batteries that fail due to fire, wreckage, explosion, or freezing
- Broken batteries
- Batteries damaged by a non-OEM charger
- Batteries to which an additive is added
- Batteries which have been improperly stored and allowed to discharge
- Any battery pack with other manufacturer's products
- Any battery improperly installed or with loose or corroded hardware
- Batteries that have been submerged in water

This warranty provides no coverage for personal loss or expense, including mileage, transportation costs, hotels, meals, shipping or handling fees, product pick-up or delivery, replacement rentals, loss of product use, loss of profits, or loss of vacation or personal time.

THE EXCLUSIVE REMEDY FOR BREACH OF THIS WARRANTY SHALL BE, AT GEM WAEV LLC'S OPTION, REPAIR OR REPLACEMENT OF ANY DEFECTIVE MATERIALS, COMPONENTS, OR PRODUCTS. THE REMEDIES SET FORTH IN THIS WARRANTY ARE THE ONLY REMEDIES AVAILABLE TO ANY PERSON FOR BREACH OF THIS WARRANTY. GEM WAEV LLC SHALL HAVE NO LIABILITY TO ANY PERSON FOR INCIDENTAL, CONSEQUENTIAL OR SPECIAL DAMAGES OF ANY DESCRIPTION, WHETHER ARISING OUT OF EXPRESS OR IMPLIED WARRANTY OR ANY OTHER CONTRACT, NEGLIGENCE, OR OTHER TORT OR OTHERWISE. THIS EXCLUSION OF CONSEQUENTIAL, INCIDENTAL, AND SPECIAL DAMAGES IS INDEPENDENT FROM AND SHALL SURVIVE ANY FINDING THAT THE EXCLUSIVE REMEDY FAILED OF ITS ESSENTIAL PURPOSE.

THE IMPLIED WARRANTY OF FITNESS FOR A PARTICULAR PURPOSE IS EXCLUDED FROM THIS LIMITED WARRANTY. ALL OTHER IMPLIED WARRANTIES (INCLUDING BUT NOT LIMITED TO THE IMPLIED WARRANTY OF MERCHANTABILITY) ARE LIMITED IN DURATION TO THE ABOVE WARRANTY PERIODS. GEM WAEV LLC DISCLAIMS ALL EXPRESS WARRANTIES NOT STATED IN THIS WARRANTY. SOME STATES DO NOT PERMIT THE EXCLUSION OR LIMITATION OF INCIDENTAL OR CONSEQUENTIAL DAMAGES OR ALLOW LIMITATIONS ON THE DURATION OF IMPLIED WARRANTIES, SO THE ABOVE LIMITATIONS MAY NOT APPLY TO YOU IF INCONSISTENT WITH CONTROLLING STATE LAW.

HOW TO OBTAIN WARRANTY SERVICE

If your vehicle requires warranty service, you must take it to a GEM Servicing Dealer. When requesting warranty service you must present your copy of the Warranty Registration Form to the dealer. (THE COST OF TRANSPORTATION TO AND FROM THE DEALER IS YOUR RESPONSIBILITY). GEM WAEV LLC suggests that you use your original selling dealer; however, you may use any GEM Servicing Dealer to perform warranty service.

In the country where your product was purchased:

Warranty or Service Bulletin repairs must be done by an authorized GEM dealer. If you move or are traveling within the country where your product was purchased, Warranty and Service Bulletin repairs may be requested from any authorized GEM dealer that sells the same line as your product.

Outside the country where your product was purchased:

If you are traveling temporarily outside the country where your product was purchased, you should take your product to an authorized GEM dealer. You must show the dealer photo identification from the country of the selling dealer's authorized location as proof of residence. Upon residence verification, the servicing dealer will be authorized to perform the warranty repair.

If you move:

If you move to another country, be sure to contact GEM Customer Assistance and the customs department of the destination country before you move. Product importation rules vary considerably from country to country. You may be required to present documentation of your move to GEM in order to continue your warranty coverage. You may also be required to obtain documentation from GEM in order to register your product in your new country. You should warranty register your product at a local GEM dealer in your new country immediately after you move to continue your warranty coverage and to ensure that you receive information and notices regarding your vehicle.

If you purchase from a private party:

If you purchase a GEM vehicle from a private party, to be kept and used outside of the country in which the product was originally purchased, all warranty coverage will be denied. You must nonetheless register your product under your name and address with a local GEM dealer in your country to ensure that you receive safety information and notices regarding your product.

WARRANTY

EXPORTED PRODUCTS

EXCEPT WHERE SPECIFICALLY REQUIRED BY LAW, THERE IS NO WARRANTY OR SERVICE BULLETIN COVERAGE ON THIS PRODUCT IF IT IS SOLD OUTSIDE THE COUNTRY OF THE SELLING DEALER'S AUTHORIZED LOCATION. This policy does not apply to products that have received authorization for export from GEM WAEV LLC. Dealers may not give authorization for export. You should consult an authorized dealer to determine this product's warranty or service coverage if you have any questions. This policy does not apply to products registered to government officials or military personnel on assignment outside the country of the selling dealer's authorized location. This policy does not apply to Safety Bulletins.

NOTICE

If your product is registered outside of the country where it was purchased and you have not followed the procedure set above, your product will no longer be eligible for warranty or service bulletin coverage of any kind, other than safety recalls. Products registered to government officials or military personnel on assignment outside of the country where the product was purchased will continue to be covered by the Limited Warranty.

Please work with your dealer to resolve any warranty issues. Dealership contacts can be found via this website, if needed:

www.gemcar.com

Should your dealer require any additional assistance, they will contact the appropriate person at GEM WAEV LLC.

This warranty gives you specific legal rights, and you may also have other rights which vary from state to state or in different countries. If any of the above terms are void because of federal, state, local law, all other warranty terms will remain in effect.

For questions call GEM WAEV Owner Connections:

United States & Canada: 855-RIDEGEM (855-743-3436)

To report a safety defect to Transport Canada, you may either fill out an online defect complaint form at their website:

English: <http://www.tc.gc.ca/recalls>

French: <http://www.tc.gc.ca/rappels>

Or contact their Defect Investigations and Recalls Division by calling toll-free 1-800-333-0510 (Canada) or 819-994-3328 (Ottawa-Gatineau area /International).

MAINTENANCE LOG

DATE	MILES (KM) OR HOURS	TECHNICIAN	SERVICE PERFORMED / COMMENTS

12-Volt Terminal Board Connections
42

A

Adjustable Tilt Steering Column 52
Alternate Battery Charging Method
39
Auxiliary Battery Storage79

B

Batteries35. 76
Battery Care During Storage . . .79
Battery Charging37
Battery Cleaning79
Battery Handling Precautions . .40
Battery Inspections/Maintenance77
Battery Pack35
Battery Performance Tips36
Battery Replacement.78
Brake/Accelerator Pedal44
Brake Fluid65
Brake Inspection65
BRAMMO® Lithium-Ion Cold
Battery Performance41

C

Cargo Limit Warning (e2/e4/e6) 15
Carrying Cargo21
Check Battery Cables and Wiring78
Check Battery Connections . . .78
Check Battery Hold-Down Bars 78
Check Fluid Levels81
Chrome Bumpers/Rugged Bumpers
51
Cleaning and Storage80
Cleaning Seats80
Cleaning the Interior80
Cleaning Windshields, Windows
and Solar Panels80
Clean the Exterior80
Console.25

D

Digital/Analog Gauge29
Dome Light45
Doors46
Drive Mode/Charging Indicator .32
Drive Mode Switch29
Driving in Reverse.56
Driving Procedure55

E

Electrical Components49
Equipment Modifications18
Exhibition Driving20
Exported Products.92

F

Failure to Inspect Before
Operating19
Fast Charge Receptacle38
Fuse and Relay Recommendations
68
Fuses and Relays67

G

Gem Customer Service7
General Warnings7
Glove Box35
Grab Handle Package50
Gross Vehicle Weight Rating
(GVWR).17

H	
Headlight Beam Adjustment . . .	75
Headlight, Turn Signal, and Brake Light Replacement	75
Heated Windshield	52
Heater/Fan	52
Hitches	51
Hood	51
Hot Components	22
How to Obtain Warranty Service	91

I	
Improper Tire Maintenance . . .	21
INDICATOR LAMPS	30
Information Display	31

K	
Key Switch	28

L	
LEAD ACID BATTERY PACK LIMITED WARRANTY	87
Left Control Lever	26
Lights	75
LI-ION BATTERY LIMITED WARRANTY	88
LIMITATIONS OF WARRANTIES AND REMEDIES	89
LIMITED WARRANTY	87

M	
Maintenance Log	93
Manufacturer's Label	8
Miles/Kilometers Indicator	31
MODE BUTTON	29

N	
NOTICE	92

O	
On-Board Charger	36
Operating a Damaged Vehicle . .	20
Operating at Excessive Speeds	20
Operating without Instruction . .	18
Operator Safety	16

P	
Park Brake Lever	45
Parking on an Incline	57
Parking the Vehicle	57
Periodic Maintenance Chart . . .	63
Precautions During Maintenance	22
Pre-Ride Inspection	53
Proper Seat Belt Use	47

R	
Radio Compliance Statements . .	8
Rear Accessory Backs	50
REGISTRATION	88
Replacement Keys	9
Rider Information Center	31
Right Control Lever	27
Rollover Risk Warning	14

S

Safety Labels and Locations . . .	11
Safety Symbols	3
Seat Adjustment	46
Seat Belt Inspection	48
Seat Belts	18, 47
Seat Belt Safety Tips	48
Seat Belt Warning	15
Service Disconnect	42
Service Indicator	31
Signal Words	3
Solar Panel	49
Specifications	83
Speedometer	29
Standard Charge Receptacle . .	38
State of Charge	32
Steel Wheel Hub Inspection . .	73
Steering Wheel Inspection . . .	64
Steering Wheel Tilt Adjustment .	35
Stereo system	48
Storage Tips	80
Storing the Vehicle	81

T

Tire Pressure	69
Tires	69
Tire Tread Depth	70
Towing Loads (eL XD)	57
Traction Battery Configurations .	77
Traction Battery Locations	77
Transporting the Vehicle	58
Turning Improperly	20

U

Unauthorized Use of the Vehicle	21
Under Dash Lighting	46
Upper Dash Removal/Installation	66
USB Port	35

V

Vehicle Emission Control Information (VECI)	8
Vehicle Rollover	21
Vehicle Tie-Down Loading And Unloading	58
Minimum Working Load Limit (WLL)	58
Tie-Down Locations	61
Ventilation When Charging Batteries (Lead Acid Batteries Only)	19

W

Warning Symbols	3
Wheel Installation	72
Wheel Nut Torque	70
Wheel Removal	71
Windshield Washer	52



WAEV

Waev Inc.
2114 W Ball Rd.
Anaheim, CA 92804

Part No. 9941150 Rev 01
Printed in USA