

# Vauxhall Mokka

Owner's Manual





---

# Contents

Introduction .....	2
In brief .....	6
Keys, doors and windows .....	19
Seats, restraints .....	34
Storage .....	54
Instruments and controls .....	70
Lighting .....	106
Climate control .....	116
Driving and operating .....	123
Vehicle care .....	162
Service and maintenance .....	204
Technical data .....	207
Customer information .....	219
Index .....	224

## Introduction

Fuel	Designation	<input type="text"/>		
Engine oil	Grade	<input type="text"/>		
	Viscosity	<input type="text"/>		
Tyre pressure	Tyre size		Front	Rear
	Summer tyres	<input type="text"/>	<input type="text"/>	<input type="text"/>
	Winter tyres	<input type="text"/>	<input type="text"/>	<input type="text"/>
Weights	Gross vehicle weight rating	<input type="text"/>		
	- Kerb weight, basic model	<input type="text"/>		
	= Loading	<input type="text"/>		

## Vehicle specific data

Please enter your vehicle's data on the previous page to keep it easily accessible. This information is available in the sections "Service and maintenance" and "Technical data" as well as on the identification plate.

## Introduction

Your vehicle is a designed combination of advanced technology, safety, environmental friendliness and economy.

This Owner's Manual provides you with all the necessary information to enable you to drive your vehicle safely and efficiently.

Make sure your passengers are aware of the possible risk of accident and injury which may result from improper use of the vehicle.

You must always comply with the specific laws and regulations of the country that you are in. These laws may differ from the information in this Owner's Manual.

Disregarding the description given in this manual may affect your warranty.

When this Owner's Manual refers to a workshop visit, we recommend your Vauxhall Authorised Repairer. For gas vehicles, we recommend a Vauxhall Authorised Repairer licensed to service gas vehicles.

All Vauxhall Authorised Repairers provide first-class service at reasonable prices. Experienced mechanics trained by Vauxhall work according to specific Vauxhall instructions.

The customer literature pack should always be kept ready to hand in the vehicle.

## Using this manual

- This manual describes all options and features available for this model. **Certain descriptions, including those for display and menu functions, may not apply to your vehicle due to model variant, country specifications, special equipment or accessories.**
- The "In brief" section will give you an initial overview.

- The table of contents at the beginning of this manual and within each section shows where the information is located.
- The index will enable you to search for specific information.
- This Owner's Manual depicts left-hand drive vehicles. Operation is similar for right-hand drive vehicles.
- The Owner's Manual uses the engine identifier code. The corresponding sales designation and engineering code can be found in the section "Technical data".
- Directional data, e.g. left or right, or front or back, always relate to the direction of travel.
- Displays may not support your specific language.
- Display messages and interior labelling are written in **bold** letters.

## Danger, Warnings and Cautions

### **⚠ Danger**

Text marked **⚠ Danger** provides information on risk of fatal injury. Disregarding this information may endanger life.

### **⚠ Warning**

Text marked **⚠ Warning** provides information on risk of accident or injury. Disregarding this information may lead to injury.

### **Caution**

Text marked **Caution** provides information on possible damage to the vehicle. Disregarding this information may lead to vehicle damage.

## Symbols

Page references are indicated with ⇨.  
⇨ means "see page".

Page references and index entries refer to the indented headings given in the section table of content.

Thank you for choosing a Vauxhall.

We wish you many hours of pleasurable driving.

**Your Vauxhall Team**



## In brief

### Initial drive information

#### Vehicle unlocking



Press  to unlock the doors and load compartment. Open the doors by pulling the handles. To open the tailgate, push the touchpad switch below the handle.

Radio remote control ⇨ 20, Central locking system ⇨ 21, Load compartment ⇨ 24.

#### Seat adjustment

##### Longitudinal adjustment



Pull handle, slide seat, release handle. Try to move the seat back and forth to ensure that the seat is locked in place.

Seat position ⇨ 35, Seat adjustment ⇨ 36.



### Backrest inclination



Pull lever, adjust inclination and release lever. Allow the seat to engage audibly.

Seat position ⇨ 35, Seat adjustment ⇨ 36.

### Seat height



Lever pumping motion

up : seat higher

down : seat lower

Seat position ⇨ 35, Seat adjustment ⇨ 36.

### Seat inclination



Press switch

top : front end higher

bottom : front end lower

Seat position ⇨ 35, Seat adjustment ⇨ 36.

## Head restraint adjustment



Pull the head restraint upwards. Press the catch (1) to release and push the head restraint downwards. Head restraints ⇨ 34.

## Seat belt



Pull out the seat belt and engage in belt buckle. The seat belt must not be twisted and must fit close against the body. The backrest must not be tilted back too far (maximum approx. 25°). To release belt, press red button on belt buckle.

Seat position ⇨ 35, Seat belts ⇨ 39, Airbag system ⇨ 42.

## Mirror adjustment

### Interior mirror



To adjust the mirror, move the mirror housing in the desired direction.

Manual anti-dazzle interior mirror ⇨ 28, Automatic anti-dazzle interior mirror ⇨ 29.

## Exterior mirrors



Select the relevant exterior mirror and adjust it.

Convex exterior mirrors ⇨ 27,  
Electric adjustment ⇨ 27, Folding  
exterior mirrors ⇨ 27, Heated  
exterior mirrors ⇨ 28.

## Steering wheel adjustment



Unlock the lever, adjust the steering wheel, then engage the lever and ensure it is fully locked.

Do not adjust the steering wheel unless the vehicle is stationary and the steering wheel lock has been released.

Airbag system ⇨ 42, Ignition positions ⇨ 125.

## Instrument panel overview



<p><b>1</b> Central locking system ..... 21</p> <p><b>2</b> Power windows ..... 30</p> <p><b>3</b> Exterior mirrors ..... 27</p> <p><b>4</b> Light switch ..... 106</p> <p><b>5</b> Cruise control ..... 139</p> <p style="padding-left: 20px;">Speed limiter ..... 140</p> <p style="padding-left: 20px;">Forward collision alert ..... 141</p> <p><b>6</b> Side air vents ..... 121</p> <p><b>7</b> Turn and lane-change signals ..... 112</p> <p style="padding-left: 20px;">Headlight flash ..... 108</p> <p style="padding-left: 20px;">Low beam and high beam . . 107</p> <p style="padding-left: 20px;">Buttons for Driver Information Centre ..... 88</p> <p><b>8</b> Instruments ..... 77</p> <p><b>9</b> Steering wheel controls ..... 71</p> <p><b>10</b> Windscreen wiper, windscreen washer system ... 72</p> <p style="padding-left: 20px;">Rear window wiper, rear window washer system ..... 74</p> <p><b>11</b> Centre air vents ..... 121</p>	<p><b>12</b> Electronic Stability Control (ESC) ..... 137</p> <p style="padding-left: 20px;">Hazard warning flashers .... 111</p> <p style="padding-left: 20px;">Control indicator for airbag deactivation ..... 83</p> <p><b>13</b> Anti-theft alarm system status LED ..... 25</p> <p><b>14</b> Info-Display ..... 92</p> <p><b>15</b> Instrument panel storage ..... 54</p> <p><b>16</b> Glovebox ..... 55</p> <p><b>17</b> Infotainment system</p> <p><b>18</b> Climate control system ..... 116</p> <p><b>19</b> Stop-start system ..... 126</p> <p style="padding-left: 20px;">Fuel selector ..... 78</p> <p><b>20</b> AUX input, USB input, SD card slot</p> <p><b>21</b> Selector lever, manual transmission ..... 133</p> <p style="padding-left: 20px;">Automatic transmission ..... 130</p> <p><b>22</b> Parking brake ..... 135</p> <p><b>23</b> Power outlet ..... 76</p> <p><b>24</b> Parking assist ..... 143</p> <p style="padding-left: 20px;">Descent control system ..... 85</p>	<p><b>25</b> Ignition switch with steering wheel lock ..... 125</p> <p><b>26</b> Horn ..... 72</p> <p style="padding-left: 20px;">Driver airbag ..... 45</p> <p><b>27</b> Steering wheel adjustment . . 71</p> <p><b>28</b> Bonnet release lever ..... 164</p> <p><b>29</b> Instrument panel storage ..... 54</p> <p style="padding-left: 20px;">Fuse box ..... 180</p>
---	---	---

## Exterior lighting



Turn light switch:

- 0 : lights off
- ☛☛ : sidelights
- ☛☛☛ : low beam



### Automatic light control

- AUTO** : automatic light control: exterior lighting is switched on and off automatically
- ☛ : activation or deactivation of the automatic light control
- ☛☛ : sidelights
- ☛☛☛ : low beam

### Fog lights

Press light switch:

- ☛☛☛ : front fog lights
- ☛☛☛☛ : rear fog light

Lighting ⇨ 106.

## Headlight flash, high beam and low beam



- headlight flash : pull lever
- high beam : push lever
- low beam : push or pull lever

Automatic light control ⇨ 107, High beam ⇨ 107, Headlight flash ⇨ 108, Adaptive forward lighting ⇨ 109.

### Turn and lane-change signals



lever up : right turn signal  
lever down : left turn signal

Turn and lane-change signals  
⇨ 112.

### Hazard warning flashers



Operated by pressing .  
Hazard warning flashers ⇨ 111.

### Horn



Press .

## Washer and wiper systems

### Windscreen wiper

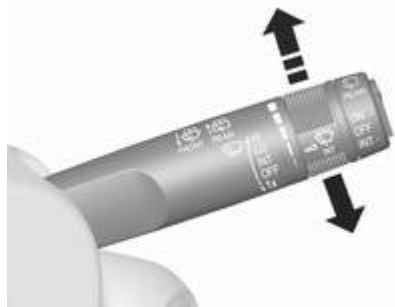

- HI** : fast
- LO** : slow
- INT** : interval wiping or automatic wiping with rain sensor
- OFF** : off

For a single wipe when the windscreen wiper is off, press the lever down to position **1x**.

Windscreen wiper ⇨ 72, Wiper blade replacement ⇨ 170.

### Windscreen washer system



Pull lever.

Windscreen washer system ⇨ 72,  
Washer fluid ⇨ 167.

### Rear window wiper

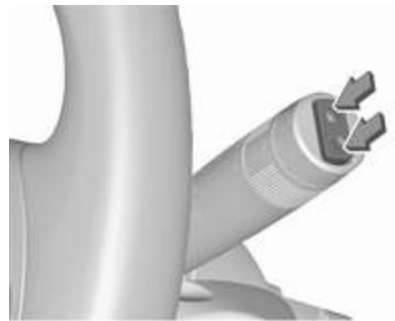

Press the rocker switch to activate the rear window wiper:

- upper switch : continuous operation
- lower switch : intermittent operation
- middle position : off



## Rear window washer

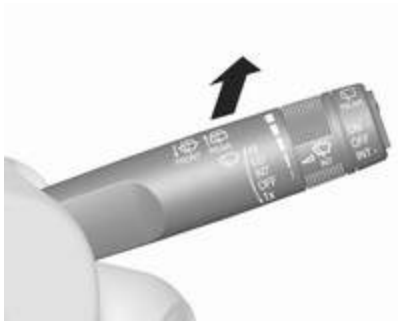

Push lever.

Washer fluid is sprayed on the rear window and the wiper wipes a few times.

Rear window wiper/washer ⇨ 74.

## Climate control

Heated rear window, heated exterior mirrors



The heating is operated by pressing .

Heated rear window ⇨ 31.

## Demisting and defrosting the windows



Press .

Set the temperature control to the highest level.

Heated rear window  on.

Climate control system ⇨ 116.

## Transmission

### Manual transmission

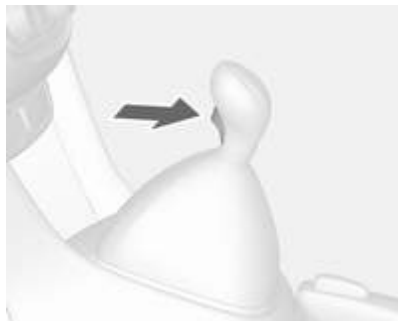

Reverse: with the vehicle stationary, depress clutch pedal, press the release button on the selector lever and engage the gear.

If the gear does not engage, set the lever to neutral, release the clutch pedal and depress again; then repeat gear selection.

Manual transmission ⇨ 133.

### Automatic transmission



**P** : park  
**R** : reverse  
**N** : neutral  
**D** : drive

Manual mode: Move selector lever to **M**.

**+** : higher gear  
**-** : lower gear

The selector lever can only be moved out of **P** when the ignition is on and the brake pedal is applied. To engage **P** or **R**, press the release button.

Automatic transmission ⇨ 130.

## Starting off

### Check before starting off

- Tyre pressure and condition  
⇨ 184, ⇨ 217.
- Engine oil level and fluid levels  
⇨ 165.
- All windows, mirrors, exterior lighting and number plates are free from dirt, snow and ice and are operational.
- Proper position of mirrors, seats, and seat belts ⇨ 27, ⇨ 35, ⇨ 40.
- Brake function at low speed, particularly if the brakes are wet.

## Starting the engine

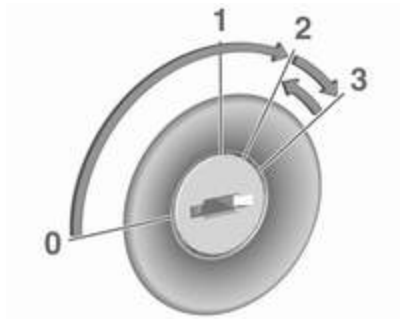

- Turn key to position **1**.
- Move the steering wheel slightly to release the steering wheel lock.
- Operate clutch and brake.
- Automatic transmission in **P** or **N**.
- Do not operate accelerator pedal.
- Diesel engines: turn the key to position **2** for preheating and wait until control indicator  extinguishes.
- Turn key to position **3** and release.

Starting the engine ⇨ 125.

## Stop-start system



If the vehicle is at a low speed or at a standstill and certain conditions are fulfilled, activate an Autostop as follows:

- Depress the clutch pedal.
- Shift the selector lever to **N**.
- Release the clutch pedal.

An Autostop is indicated by the needle at the **AUTOSTOP** position in the tachometer.

To restart the engine, depress the clutch pedal again.

Stop-start system ⇨ 126.

## Parking

### Warning

- Do not park the vehicle on an easily ignitable surface. The high temperature of the exhaust system could ignite the surface.
- Always apply the parking brake. Activate the parking brake without pressing the release button. Apply as firmly as possible on a downhill slope or uphill slope. Depress brake pedal at the same time to reduce operating force.
- Switch off the engine.
- If the vehicle is on a level surface or uphill slope, engage first gear or set the selector lever to position **P** before removing the ignition key. On an uphill slope, turn the front wheels away from the kerb. If the vehicle is on a downhill slope, engage reverse gear or

set the selector lever to position **P** before removing the ignition key. Turn the front wheels towards the kerb.

- Close the windows and the sunroof.
- Remove the ignition key from the ignition switch. For vehicles with automatic transmission, the key can only be removed when the selector lever is in position **P**.

Turn the steering wheel until the steering wheel lock is felt to engage.

- Lock the vehicle with  on the radio remote control.  
Activate the anti-theft alarm system ⇨ 25.
- The engine cooling fans may run after the engine has been switched off ⇨ 164.

### Caution

After running at high engine speeds or with high engine loads, operate the engine briefly at a low load or run in neutral for approx. 30 seconds before switching off, in order to protect the turbocharger.

Keys, locks ⇨ 19, Laying the vehicle up for a long period of time ⇨ 163.

## Keys, doors and windows

<b>Keys, locks</b> .....	<b>19</b>
Keys .....	19
Radio remote control .....	20
Memorised settings .....	21
Central locking system .....	21
Delayed locking .....	23
Automatic locking .....	23
Child locks .....	24
<b>Doors</b> .....	<b>24</b>
Load compartment .....	24
<b>Vehicle security</b> .....	<b>25</b>
Anti-theft locking system .....	25
Anti-theft alarm system .....	25
Immobiliser .....	26
<b>Exterior mirrors</b> .....	<b>27</b>
Convex shape .....	27
Electric adjustment .....	27
Folding mirrors .....	27
Heated mirrors .....	28
<b>Interior mirrors</b> .....	<b>28</b>
Manual anti-dazzle .....	28
Automatic anti-dazzle .....	29

<b>Windows</b> .....	<b>29</b>
Windscreen .....	29
Manual windows .....	29
Power windows .....	30
Heated rear window .....	31
Sun visors .....	31
<b>Roof</b> .....	<b>32</b>
Sunroof .....	32

## Keys, locks

### Keys

<b>Caution</b>
Do not attach heavy or bulky items to the ignition key.

### Replacement keys

The key number is specified on a detachable tag.

The key number must be quoted when ordering replacement keys as it is a component of the immobiliser system.

Locks ⇨ 201.

### Lock cylinders

Designed to free-wheel if they are forcefully rotated without the correct key or if the correct key is not fully inserted. To reset, turn cylinder with the correct key until its slot is vertical, remove key then re-insert it. If the cylinder still free-wheels, turn the key through 180° and repeat operation.

### Key with foldaway key section



Press button to extend.

To fold the key, first press the button.

### Radio remote control



Used to operate:

- central locking system
- anti-theft alarm system

The radio remote control has a range of approx. 30 metres. It can be restricted by external influences. The hazard warning flashers confirm operation.

Handle with care, protect from moisture and high temperatures and avoid unnecessary operation.

### Fault

If the central locking system cannot be operated with the radio remote control, it may be due to the following:

- The range is exceeded.
- The battery voltage is too low.
- Frequent, repeated operation of the radio remote control while not in range, which will require re-synchronisation.
- Overload of the central locking system by operating at frequent intervals, the power supply is interrupted for a short time.
- Interference from higher-power radio waves from other sources.

Unlocking ⇨ 21.

### Basic settings

Some settings can be changed in the menu **Settings** in the Info-Display. Vehicle personalisation ⇨ 99.

### Radio remote control battery replacement

Replace the battery as soon as the range reduces.



Batteries do not belong in household waste. They must be disposed of at an appropriate recycling collection point.

### Key with foldaway key section



Extend the key and open the unit. Replace the battery (battery type CR 2032), paying attention to the installation position. Close the unit and synchronise.

### Radio remote control synchronisation

After replacing the battery, unlock the door with the key in the driver's door lock. The radio remote control is synchronised when the ignition is switched on.

### Memorised settings

Whenever the key is removed from the ignition switch, the following settings are automatically memorised by the key:

- lighting
- infotainment system
- central locking system

The saved settings are automatically used the next time the memorised key is inserted into the ignition switch and turned to position 1 ↷ 125.

A precondition is that **Personalization by driver** is activated in the personal settings of the Graphic-Info-Display. This must be set for each key used. On vehicles equipped with

Colour-Info-Display, the personalisation is permanently activated.

Vehicle personalisation ↷ 99.

### Central locking system

Unlocks and locks doors, load compartment and fuel filler flap.

A pull on an interior door handle unlocks the respective door. Pulling the handle again opens the door.

#### Notice

In the event of an accident in which airbags or belt pretensioners are deployed, the vehicle is automatically unlocked.

#### Notice

A short time after unlocking with the remote control the doors are locked automatically if no door has been opened.



## Unlocking

### Radio remote control



Press .

Two settings are selectable:

- To unlock only the driver's door, load compartment and fuel filler flap, press  once. To unlock all doors, press  twice.
- Press  once to unlock all doors, load compartment and fuel filler flap.

The setting can be changed in the Settings menu in the Info-Display. Vehicle personalisation ↻ 99.

The setting can be saved for the key being used. Memorised settings ↻ 21.

## Locking

Close doors, load compartment and fuel filler flap.



Press .

If the driver's door is not closed properly, the central locking system will not work.

## Central locking buttons

Locks or unlocks all doors, the load compartment and fuel filler flap from inside the passenger compartment.



The central locking buttons are located in the driver's door.

Press  to lock.

Press  to unlock.



## Fault in radio remote control system

### Unlocking



Manually unlock the driver's door by turning the key in the lock. Switch on the ignition and press  to unlock the other doors, load compartment and fuel filler flap. By switching on the ignition, the anti-theft locking system is deactivated.

### Locking

Manually lock the driver's door by turning the key in the lock.

## Fault in central locking system

### Unlocking

Manually unlock the driver's door by turning the key in the lock. The other doors can be opened by pulling the interior handle twice. The load compartment and fuel filler flap cannot be opened. To deactivate the anti-theft locking system, switch on the ignition  25.

### Locking

Push inside locking knob of all doors except driver's door. Then close the driver's door and lock it from the outside with the key. The fuel filler flap and tailgate cannot be locked.

## Delayed locking

This feature will delay the actual locking of the doors and arming of the anti-theft alarm system for five seconds when the power door lock switch or radio remote control is used to lock the vehicle.

This can be changed in the vehicle settings.

Vehicle personalisation  99.

**ON:** When pressing the central locking button, three chimes will sound to signal delayed locking is activated.

The doors will not lock until five seconds after the last door is closed. You can temporarily override delayed locking by pressing the central locking button or the locking button on the radio remote control.

**OFF:** The doors will lock immediately when pressing the power lock switch or  on the radio remote control.

## Automatic locking

This security feature can be configured to automatically lock all doors, load compartment and fuel filler flap as soon as a certain speed is exceeded.

Additionally, it is configurable to unlock the driver's door or all doors after the ignition is switched off and the ignition key is removed (manual transmission) or the selector lever is moved to position **P** (automatic transmission).

Settings can be changed in the menu **Settings** in the Info-Display. Vehicle personalisation ↻ 99.

The settings can be saved for the key being used ↻ 21.

### Child locks



#### **Warning**

Use the child locks whenever children are occupying the rear seats.

Using a key or suitable screwdriver, turn the child lock in the rear door to the horizontal position. The door cannot be opened from the inside. For deactivation turn the child lock to the vertical position.

## Doors

### Load compartment

#### Tailgate

##### Opening



After unlocking, push the touchpad switch and open the tailgate.

##### Closing

Use one of the interior handles.

Do not push the touchpad switch or the brand emblem whilst closing as this will unlock the tailgate again.

Central locking system ↻ 21.

## General hints for operating tailgate

### ⚠ Danger

Do not drive with the tailgate open or ajar, e.g. when transporting bulky objects, since toxic exhaust gases, which cannot be seen or smelled, could enter the vehicle. This can cause unconsciousness and even death.

### Caution

Before opening the tailgate, check overhead obstructions, e.g. a garage door, to avoid damage to the tailgate. Always check the moving area above and behind the tailgate.

### Notice

The installation of certain heavy accessories onto the tailgate may affect its ability to remain open.

## Vehicle security

### Anti-theft locking system

#### ⚠ Warning

Do not use the system if there are people in the vehicle! The doors cannot be unlocked from the inside.

The system deadlocks all the doors. All doors must be closed otherwise the system cannot be activated.

If the ignition was on, the driver's door must be opened and closed once so that the vehicle can be secured.

Unlocking the vehicle disables the mechanical anti-theft locking system. This is not possible with the central locking button.

### Activating



Press  on the radio remote control twice within five seconds.

### Anti-theft alarm system

The anti-theft alarm system is combined with the central locking system.

It monitors:

- doors, load compartment, bonnet
- ignition

Unlocking the vehicle deactivates the anti-theft alarm system.

## Activation

- Self-activated 30 seconds after locking the vehicle (initialisation of the system).
- Directly by pressing  on the radio remote control once more after locking.

### Notice

Changes to the vehicle interior, e.g. the use of seat covers, and open windows, could impair the function of passenger compartment monitoring.

## Status LED



Status LED is integrated in the sensor on top of the instrument panel.

Status during the first 30 seconds of anti-theft alarm system activation:

LED illuminates : test, arming delay  
 LED flashes : doors, tailgate or bonnet not completely closed, or system fault

Status after system is armed:

LED flashes : system is armed slowly

Seek the assistance of a workshop in the event of faults.

## Deactivation

Unlocking the vehicle deactivates the anti-theft alarm system.

## Alarm

The alarm can be silenced by pressing any button of the radio remote control or by switching on the ignition.

The anti-theft alarm system can be deactivated by pressing  or switching on the ignition.

## Auto door locking

After unlocking doors with the radio remote control, if no door is opened or the key is not located in ignition switch position **2** or **3** ⇄ 125 within three minutes of unlocking, all doors are locked automatically and the anti-theft alarm system is re-activated.

## Automatic door unlocking

All doors will be automatically unlocked when impact is delivered to impact sensors while the ignition is switched on.

However, the doors may not be unlocked if mechanical problems occur with the door locking system or battery.

## Immobiliser



The system is part of the ignition switch and checks whether the vehicle is allowed to be started with the key being used.

The immobiliser is activated automatically after the key has been removed from the ignition switch.

If the control indicator  flashes when the ignition is on, there is a fault in the system; the engine cannot be started. Switch off the ignition and repeat the start attempt.

If the control indicator continues flashing, attempt to start the engine using the spare key and seek the assistance of a workshop.

#### Notice

The immobiliser does not lock the doors. You should always lock the vehicle after leaving it and switch on the anti-theft alarm system  21,  25.

Control indicator   87.

## Exterior mirrors

### Convex shape

The convex exterior mirror contains an aspherical area and reduces blind spots. The shape of the mirror makes objects appear smaller, which will affect the ability to estimate distances.

### Electric adjustment



Select the relevant exterior mirror by turning the control to left (**L**) or right (**R**). Then swivel the control to adjust the mirror.

In position **0** no mirror is selected.

## Folding mirrors

### Manual folding



For pedestrian safety, the exterior mirrors will swing out of their normal mounting position if they are struck with sufficient force. Reposition the mirror by applying slight pressure to the mirror housing.

### Electric folding



Turn control to **0**, then push the control backwards. Both exterior mirrors will fold in.

Push the control backwards again - both exterior mirrors return to their original position.

### Heated mirrors



Operated by pressing .

Heating functions with the engine running and is switched off automatically after a short time.

### Interior mirrors

#### Manual anti-dazzle



To reduce dazzle, adjust the lever on the underside of the mirror housing.

## Automatic anti-dazzle



Dazzle from following vehicles at night is automatically reduced.

## Windows

### Windscreen

#### Heat-reflecting windscreen

The heat-reflecting windscreen has a coating which reflects solar radiation. Also data signals, e.g. from toll stations, might be reflected.

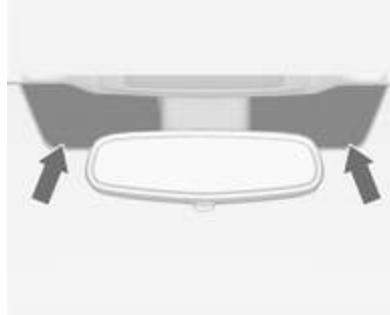

The marked areas of the windscreen behind the interior mirror are not covered with the coating. Devices for electronic data recording and fee payment must be attached in these areas. Otherwise data recording malfunctions may occur.

### Windscreen stickers

Do not attach stickers such as toll road stickers or similar on the windscreen in the area of the interior mirror. Otherwise the detection zone of the sensor and the view area of the camera in the mirror housing could be restricted.

### Windscreen replacement

#### Caution

If the vehicle has a front-looking camera sensor for the driver assistance systems, it is very important that any windscreen replacement is performed accurately according to Vauxhall specifications. Otherwise, these systems may not work properly and there is a risk of unexpected behaviour and/or messages from these systems.

### Manual windows

The door windows can be opened or closed with the window cranks.

## Power windows

### ⚠ Warning

Take care when operating the power windows. Risk of injury, particularly to children.

If there are children on the rear seats, switch on the child safety system for the power windows.

Keep a close watch on the windows when closing them. Ensure that nothing becomes trapped in them as they move.

Switch on ignition to operate power windows.



Operate the switch for the respective window by pushing to open or pulling to close.

Pushing or pulling gently to the first detent: window moves up or down as long as the switch is operated.

Pushing or pulling firmly to the second detent and then releasing: window moves up or down automatically with safety function enabled. To stop movement, operate the switch once more in the same direction.

## Safety function

If the window glass encounters resistance above the middle of the window during automatic closing, it is immediately stopped and opened again.

## Override safety function

In the event of closing difficulties due to frost or the like, switch on the ignition, then pull the switch to the first detent and hold. The window moves up without safety function enabled. To stop movement, release the switch.



## Child safety system for rear windows



Press  to deactivate rear power windows.

To activate, press  again.

## Overload

If the windows are repeatedly operated within short intervals, the window operation is disabled for some time.

## Initialising the power windows

If the windows cannot be closed automatically (e.g. after disconnecting the vehicle battery), activate the window electronics as follows:

1. Close doors.
2. Switch on ignition.
3. Pull switch until the window is closed and keep pulling for additional two seconds.
4. Repeat for each window.

## Heated rear window



Operated by pressing .

The LED in the button indicates activation.

Heating works with the engine running and is switched off automatically after a short time.

## Sun visors

The sun visors can be folded down or swivelled to the side to prevent dazzling.

The sun visors mirror covers should be closed when driving.

If the sun visors have a vanity mirror lamp, the lamp will illuminate when opening the vanity mirror cover.

## Roof

### Sunroof

#### ⚠ Warning

Take care when operating the sunroof. Risk of injury, particularly to children.

Keep a close eye on the movable parts when operating them. Ensure that nothing becomes trapped in them as they move.

Switch on ignition to operate the sunroof.



#### Open or close

Press switch **1** or switch **2** gently to the first detent: sunroof is opened or closed as long as the switch is operated.

Press switch **1** or switch **2** firmly to the second detent and then release: the sunroof is opened or closed automatically with safety function enabled. To stop movement, operate the switch once more.

#### Raise or close

Press switch **3** or switch **4**: sunroof is raised or closed automatically with safety function enabled.

If the sunroof is raised, it can be opened in one step by pressing switch **1**.

#### Sunblind

The sunblind is operated manually. Close or open the sunblind by sliding. When the sunroof is open, the sunblind is always open.

Dirt and debris may collect on the sunroof seal or in the track that could cause an issue with sunroof operation, noise or plug the water drainage system. Periodically open the sunroof and remove any obstacles or loose debris. Wipe the sunroof seal and roof sealing area using a clean cloth, mild soap, and water. Do not remove grease from the sunroof.

#### General hints

##### Safety function

If the sunroof encounters resistance during automatic closing, it is immediately stopped and opened again.

##### Override safety function

In the event of closing difficulties due to frost or the like, press and hold switch **2**. The sunroof closes without safety function enabled. To stop movement, release the switch.

**Initialising after a power failure**

After a power failure, it may only be possible to operate the sunroof to a limited extent. Have the system initialised by your workshop.

## Seats, restraints

<b>Head restraints</b> .....	<b>34</b>
<b>Front seats</b> .....	<b>35</b>
Seat position .....	35
Seat adjustment .....	36
Heating .....	38
<b>Seat belts</b> .....	<b>39</b>
Three-point seat belt .....	40
<b>Airbag system</b> .....	<b>42</b>
Front airbag system .....	45
Side airbag system .....	45
Curtain airbag system .....	46
Airbag deactivation .....	47
<b>Child restraints</b> .....	<b>48</b>
Child restraint systems .....	48
Child restraint installation locations .....	49
ISOFIX child restraint systems ..	52
Top-tether fastening eyes .....	53

## Head restraints

### Position

#### ⚠ Warning

Only drive with the head restraint set to the proper position.



The upper edge of the head restraint should be at upper head level. If this is not possible for extremely tall people, set to highest position, and set to lowest position for small people.

## Adjustment

### Head restraints on front seats



### Height adjustment

Pull the head restraint upwards.

To move down, press the catch (1) and push the head restraint downwards.

### Removing

Raise head restraint to its full height.

Press the catches (1) and (2) at the same time.

Pull up the head restraint.

### Horizontal adjustment



To adjust horizontally, pull the head restraint forwards. It engages in three positions.

To return to its rearmost position, pull fully forwards and release.

### Head restraints on rear seats



#### Height adjustment

Pull the head restraint upwards.

To move down, press the catch (1) and push the head restraint downwards.

#### Removal

Raise head restraint to its full height.

Press the catches (1) and (2) at the same time.

Pull up the head restraint.

## Front seats

### Seat position

#### **⚠ Warning**

Only drive with the seat correctly adjusted.

#### **⚠ Danger**

Do not sit nearer than 25 cm from the steering wheel, to permit safe airbag deployment.

#### **⚠ Warning**

Never adjust seats while driving as they could move uncontrollably.

#### **⚠ Warning**

Never store any objects under the seats.



- Sit with buttocks as far back against the backrest as possible. Adjust the distance between the seat and the pedals so that legs are slightly angled when fully pressing the pedals. Slide the front passenger seat as far back as possible.
- Set seat height high enough to have a clear field of vision on all sides and of all display instruments. There should be at least one hand of clearance between head and the headlining. Your thighs should rest lightly on the seat without pressing into it.

- Sit with shoulders as far back against the backrest as possible. Set the backrest rake so that it is possible to easily reach the steering wheel with arms slightly bent. Maintain contact between shoulders and the backrest when turning the steering wheel. Do not tilt the backrest too far back. We recommend a maximum rake of approx. 25°.
- Adjust seat and steering wheel in a way that the wrist rests on top of the steering wheel while the arm is fully extended and shoulders on the backrest.
- Adjust the steering wheel ↻ 71.
- Adjust the head restraint ↻ 34.
- Adjust the height of the seat belt ↻ 40.
- Adjust the thigh support so that there is a space approx. two fingers wide between the edge of the seat and the hollow of the knee.
- Adjust the lumbar support so that it supports the natural shape of the spine.

## Seat adjustment

Drive only with engaged seats and backrests.

### Longitudinal adjustment



Pull handle, slide seat, release handle. Try to move the seat back and forth to ensure that the seat is locked in place.

**Backrest inclination**

Pull lever, adjust inclination and release lever. Allow the backrest to engage audibly.

**Seat height**

Lever pumping motion  
up : seat higher  
down : seat lower

**Seat inclination**

Press switch  
top : front end higher  
bottom : front end lower

### Lumbar support



Adjust lumbar support using the four-way switch to suit personal requirements.

Moving support up and down: push switch up or down.

Increasing and decreasing support: push switch forwards or backwards.

### Adjustable thigh support



Pull the lever and slide the thigh support.

### Heating



Adjust heating to the desired setting by pressing  for the respective seat one or more times. The control indicator in the button indicates the setting.

Prolonged use of the highest setting for people with sensitive skin is not recommended.

Seat heating is operational when engine is running and during an Autostop.

Stop-start system ⇨ 126.



## Seat belts



The seat belts are locked during heavy acceleration or deceleration of the vehicle holding the occupants in the sitting position. Therefore the risk of injury is considerably reduced.

### ⚠ Warning

Fasten seat belt before each trip.

In the event of an accident, people not wearing seat belts endanger their fellow occupants and themselves.

Seat belts are designed to be used by only one person at a time. Child restraint system ⇨ 48.

Periodically check all parts of the belt system for damage and proper functionality.

Have damaged components replaced. After an accident, have the belts and triggered belt pretensioners replaced by a workshop.

#### Notice

Make sure that the belts are not damaged by shoes or sharp-edged objects or are trapped. Prevent dirt from getting into the belt retractors.

Seat belt reminder ⚠ ⇨ 83.

### Belt force limiters

On the front seats, stress on the body is reduced by the gradual release of the belt during a collision.

### Belt pretensioners

In the event of a head-on or rear-end collision of a certain severity, the front seat belts are tightened.

### ⚠ Warning

Incorrect handling (e.g. removal or fitting of belts) can trigger the belt pretensioners.

Deployment of the belt pretensioners is indicated by continuous illumination of control indicator ⚠ ⇨ 83.

Triggered belt pretensioners must be replaced by a workshop. Belt pretensioners can only be triggered once.

#### Notice

Do not affix or install accessories or other objects that may interfere with the operation of the belt pretensioners. Do not make any modifications to belt pretensioner components as this will invalidate the vehicle type approval.

## Three-point seat belt

### Fasten



Withdraw the belt from the retractor, guide it untwisted across the body and insert the latch plate into the buckle.

Tighten the lap belt regularly whilst driving by pulling the shoulder belt.



Loose or bulky clothing prevents the belt from fitting snugly. Do not place objects such as handbags or mobile phones between the belt and your body.

### **⚠ Warning**

The belt must not rest against hard or fragile objects in the pockets of your clothing.

## Height adjustment



1. Pull belt out slightly.
2. Shift the height adjuster upwards or press button to disengage and push the height adjuster downwards.



Adjust the height so that the belt lies across the shoulder. It must not lie across the throat or upper arm.

**⚠ Warning**

Do not adjust while driving.

### Unfasten



To release belt, press red button on belt buckle.

### Seat belts on the rear seats

The seat belt for the rear centre seat can only be withdrawn from the retractor if the backrest is engaged in upright position.

### Using seat belt during pregnancy

**⚠ Warning**

The lap belt must be positioned as low as possible across the pelvis to prevent pressure on the abdomen.

## Airbag system

The airbag system consists of a number of individual systems depending on the scope of equipment.

When triggered, the airbags inflate within milliseconds. They also deflate so quickly that it is often unnoticeable during the collision.

### ⚠ Warning

If handled improperly the airbag systems can be triggered in an explosive manner.

### Notice

The airbag systems and belt pretensioner control electronics are located in the centre console area. Do not put any magnetic objects in this area.



Do not affix any objects onto the airbag covers and do not cover them with other materials.

Each airbag is triggered only once. Have deployed airbags replaced by a workshop. Furthermore, it may be

necessary to have the steering wheel, the instrument panel, parts of the panelling, the door seals, handles and the seats replaced.

Do not make any modifications to the airbag system as this will invalidate the vehicle type approval.

When the airbags inflate, escaping hot gases may cause burns.

Control indicator  for airbag systems  83.

### Child restraint systems on front passenger seat with airbag systems

Warning according to ECE R94.02:



**EN:** NEVER use a rearward-facing child restraint on a seat protected by an ACTIVE AIRBAG in front of it; DEATH or SERIOUS INJURY to the CHILD can occur.

**DE:** Nach hinten gerichtete Kindersitze NIEMALS auf einem Sitz verwenden, der durch einen davor befindlichen AKTIVEN AIRBAG geschützt ist, da dies den TOD oder SCHWERE VERLETZUNGEN DES KINDES zur Folge haben kann.

**FR:** NE JAMAIS utiliser un siège d'enfant orienté vers l'arrière sur un siège protégé par un COUSSIN GONFLABLE ACTIF placé devant lui, sous peine d'infliger des BLESSURES GRAVES, voire MORTELLES à l'ENFANT.

**ES:** NUNCA utilice un sistema de retención infantil orientado hacia atrás en un asiento protegido por un AIRBAG FRONTAL ACTIVO. Peligro de MUERTE o LESIONES GRAVES para el NIÑO.

**RU:** ЗАПРЕЩАЕТСЯ устанавливать детское удерживающее устройство лицом назад на сиденье автомобиля,

оборудованном фронтальной подушкой безопасности, если ПОДУШКА НЕ ОТКЛЮЧЕНА! Это может привести к СМЕРТИ или СЕРЬЕЗНЫМ ТРАВМАМ РЕБЕНКА.

**NL:** Gebruik NOOIT een achterwaarts gericht kinderzitje op een stoel met een ACTIEVE AIRBAG ervoor, om DODELIJK of ERNSTIG LETSEL van het KIND te voorkomen.

**DA:** Brug ALDRIG en bagudvendt autostol på et forsæde med AKTIV AIRBAG, BARNET kan komme i LIVSFARE eller komme ALVORLIGT TIL SKADE.

**SV:** Använd ALDRIG en bakåtvänd barnstol på ett säte som skyddas med en framförvarande AKTIV AIRBAG. DÖDSFALL eller ALLVARLIGA SKADOR kan drabba BARNET.

**FI:** ÄLÄ KOSKAAN sijoita taaksepäin suunnattua lasten turvaistuinta istuimelle, jonka edessä on AKTIIVINEN TURVATYYNY, LAPSI VOI KUOLLA tai VAMMAUTUA VAKAVASTI.

**NO:** Bakovervendt barnesikringsutstyr må ALDRI brukes på et sete med AKTIV KOLLISJONSPUTE foran, da det kan føre til at BARNET utsettes for LIVSFARE og fare for ALVORLIGE SKADER.

**PT:** NUNCA use um sistema de retenção para crianças voltado para trás num banco protegido com um AIRBAG ACTIVO na frente do mesmo, poderá ocorrer a PERDA DE VIDA ou FERIMENTOS GRAVES na CRIANÇA.

**IT:** Non usare mai un sistema di sicurezza per bambini rivolto all'indietro su un sedile protetto da AIRBAG ATTIVO di fronte ad esso: pericolo di MORTE o LESIONI GRAVI per il BAMBINO!

**EL:** ΠΟΤΕ μη χρησιμοποιείτε παιδικό κάθισμα ασφαλείας με φορά προς τα πίσω σε κάθισμα που προστατεύεται από μετωπικό ΕΝΕΡΓΟ ΑΕΡΟΣΑΚΟ, διότι το παιδί μπορεί να υποστεί ΤΡΑΥΜΑΤΙΣΜΟ.

**PL:** NIE WOLNO montować fotelika dziecięcego zwróconego tyłem do kierunku jazdy na fotelu, przed którym znajduje się WŁĄCZONA PODUSZKA POWIETRZNA. Niezastosowanie się do tego zalecenia może być przyczyną ŚMIERCI lub POWAŻNYCH OBRAŻEŃ u DZIECKA.

**TR:** Arkaya bakan bir çocuk emniyet sistemini KESİNLİKLE önünde bir AKTİF HAVA YASTIĞI ile korumakta olan bir koltukta kullanmayınız. ÇOCUK ÖLEBİLİR veya AĞIR ŞEKİLDE YARALANABİLİR.

**UK:** НІКОЛІ не використовуйте систему безпеки для дітей, що встановлюється обличчям назад, на сидінні з УВІМКНЕНОЮ ПОДУШКОЮ БЕЗПЕКИ, інакше це може призвести до СМЕРТІ чи СЕРІОЗНОГО ТРАВМУВАННЯ ДИТИНИ.

**HU:** SOHA ne használnjon hátrafelé néző biztonsági gyerekülést előlről AKTÍV LÉGZSÁKKAL védett ülésen, mert a GYERMEK HALÁLÁT vagy KOMOLY SÉRÜLÉSÉT okozhatja.

**HR:** NIKADA nemojte koristiti sustav zadržavanja za djecu okrenut prema natrag na sjedalu s AKTIVNIM ZRAČNIM JASTUKOM ispred njega, to bi moglo dovesti do SMRTI ili OZBILJNIH OZLJEDA za DIJETE.

**SL:** NIKOLI ne nameščajte otroškega varnostnega sedeža, obrnjenega v nasprotni smeri vožnje, na sedež z AKTIVNO ČELNO ZRAČNO BLAZINO, saj pri tem obstaja nevarnost RESNIH ali SMRTNIH POŠKODB za OTROKA.

**SR:** NIKADA ne koristiti bezbednosni sistem za decu u kome su deca okrenuta unazad na sedištu sa AKTIVNIM VAZDUŠNIM JASTUKOM ispred sedišta zato što DETE može da NASTRADA ili da se TEŠKO POVREDI.

**MK:** НИКОГАШ не користете детско седиште свртено наназад на седиште заштитено со АКТИВНО ВОЗДУШНО ПЕРНИЧЕ пред него, затоа што детето може ДА ЗАГИНЕ или да биде ТЕШКО ПОВРЕДЕНО.

**BG:** НИКОГА не използвайте детска седалка, гледаща назад, върху седалка, която е защитена

чрез АКТИВНА ВЪЗДУШНА ВЪЗГЛАВНИЦА пред нея - може да се стигне до СМЪРТ или СЕРИОЗНО НАРАНЯВАНЕ на ДЕТЕТО.

**RO:** Nu utilizați NICIODATĂ un scaun pentru copil îndreptat spre partea din spate a mașinii pe un scaun protejat de un AIRBAG ACTIV în fața sa; acest lucru poate duce la DECESUL sau VĂTĂMAREA GRAVĂ a COPILULUI.

**CS:** NIKDY nepoužívejte dětský zadržný systém instalovaný proti směru jízdy na sedadle, které je chráněno před sedadlem AKTIVNÍM AIRBAGEM. Mohlo by dojít k VÁŽNĚMU PORANĚNÍ nebo ÚMRTÍ DÍTĚTE.

**SK:** NIKDY nepoužívajte detskú sedačku otočenú vzad na sedadle chránenom AKTÍVNÝM AIRBAGOM, pretože môže dôjsť k SMRTI alebo VÁŽNÝM ZRANENIAM DIEŤAŤA.

**LT:** JOKIU BŪDU nemontuokite atgal atgręžtos vaiko tvirtinimo sistemas sėdynėje, prieš kurią įrengta AKTYVI ORO PAGALVĖ, nes VAIKAS GALI ŽŪTI arba RIMTAI SUSIŽALOTI.

**LV:** NEKĀDĀ GADĪJUMĀ neizmantojiet uz aizmuguri vērstu bērnu sēdekļi sēdvietā, kas tiek aizsargāta ar tās priekšā uzstādītu AKTĪVU DROŠĪBAS SPILVENU, jo pretējā gadījumā BĒRNS var gūt SMAGAS TRAUMAS vai IET BOJĀ.

**ET:** ÄRGE kasutage tahapoole suunatud lapseturvaistet istmel, mille ees on AKTIIVSE TURVAPADJAGA kaitstud iste, sest see võib põhjustada LAPSE SURMA või TÕSISE VIGASTUSE.

**MT:** QATT tuża trażżin għat-tfal li jħares lejn in-naħa ta' wara fuq sit protett b'AIRBAG ATTIV quddiemu; dan jista' jikkawża l-MEWT jew ĠRIEHI SERJI lit-TFAL.

Beyond the warning required by ECE R94.02, for safety reasons never use a forward-facing child restraint system on the passenger seat with an active front airbag.

 **Danger**

Do not use a child restraint system on the passenger seat with active front airbag.

The warning label is located on both sides of the front passenger sun visor.  
Airbag deactivation ⇨ 47.

## Front airbag system

The front airbag system consists of one airbag in the steering wheel and one in the instrument panel on the front passenger side. These can be identified by the word **AIRBAG**.

The front airbag system is triggered in the event of a front-end impact of a certain severity. The ignition must be switched on.

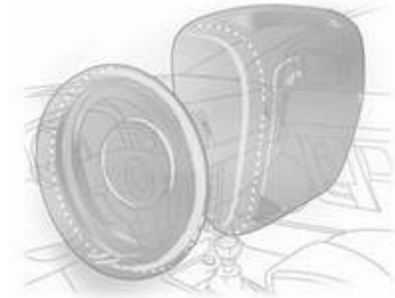

The inflated airbags cushion the impact, thereby reducing the risk of injury to the upper body and head of the front seat occupants considerably.

### ⚠ Warning

Optimum protection is only provided when the seat is in the proper position.

Seat position ⇨ 35.

Keep the area in which the airbag inflates clear of obstructions.

Fit the seat belt correctly and engage securely. Only then is the airbag able to protect.

## Side airbag system



The side airbag system consists of an airbag in each front seat backrest. This can be identified by the word **AIRBAG**.

The side airbag system is triggered in the event of a side impact of a certain severity. The ignition must be switched on.

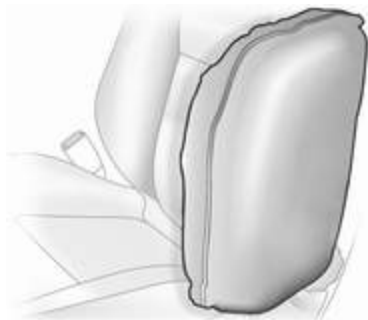

The inflated airbags cushion the impact, thereby reducing the risk of injury to the upper body and pelvis in the event of a side-on collision considerably.

### **⚠ Warning**

Keep the area in which the airbag inflates clear of obstructions.

### **Notice**

Only use protective seat covers that have been approved for the vehicle. Be careful not to cover the airbags.

## **Curtain airbag system**

The curtain airbag system consists of an airbag in the roof frame on each side. This can be identified by the word **AIRBAG** on the roof pillars.



The curtain airbag system is triggered in the event of a side-on impact of a certain severity. The ignition must be switched on.

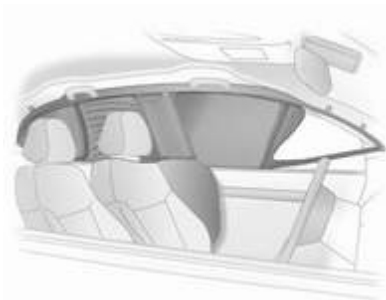

The inflated airbags cushion the impact, thereby reducing the risk of injury to the head in the event of a side-on impact considerably.

### **⚠ Warning**

Keep the area in which the airbag inflates clear of obstructions.

The hooks in the roof frame are only suitable for hanging up light articles of clothing, without coat hangers. Do not keep any items in these clothes.





## Airbag deactivation

The front passenger airbag system must be deactivated if a child restraint system is to be fitted on this seat. The side airbag and curtain airbag systems, the belt pretensioners and all driver airbag systems will remain active.



The front passenger airbag system can be deactivated via a key-operated switch on the right side of the instrument panel.

Use the ignition key to choose the position:

- OFF**  : front passenger airbags are deactivated and will not inflate in the event of a collision. Control indicator **OFF**  illuminates continuously in the centre console. A child restraint system can be installed in accordance with the chart **Child restraint installation locations** ⇨ 49. No adult person is allowed to occupy the front passenger seat.
- ON**  : front passenger airbags are active. A child restraint system must not be installed.

### Danger

Risk of fatal injury for a child using a child restraint system on a seat with activated front passenger airbag.

Risk of fatal injury for an adult person on a seat with deactivated front passenger airbag.



As long as the control indicator **OFF**  is not illuminated, the front passenger airbag system will inflate in the event of a collision.

Change status only when the vehicle is stopped with the ignition off.

Status remains until the next change.

Control indicator for airbag deactivation ⇨ 83.

## Child restraints

### Child restraint systems

We recommend the Vauxhall child restraint system which is tailored specifically to the vehicle.

When a child restraint system is being used, pay attention to the following usage and installation instructions and also those supplied with the child restraint system.

Always comply with local or national regulations. In some countries, the use of child restraint systems is forbidden on certain seats.

#### Warning

When using a child restraint system on the front passenger seat, the airbag systems for the front passenger seat must be deactivated; if not, the triggering of the airbags poses a risk of fatal injury to the child.

This is especially the case if rear-facing child restraint systems are used on the front passenger seat.

Airbag deactivation ⇨ 47.

Airbag label ⇨ 42.

### Selecting the right system

The rear seats are the most convenient location to fasten a child restraint system.

Children should travel facing rearwards in the vehicle as long as possible. This ensures that the child's backbone, which is still very weak, is under less strain in the event of an accident.

Suitable are restraint systems that comply with valid UN ECE regulations. Check local laws and regulations for mandatory use of child restraint systems.

Ensure that the child restraint system to be installed is compatible with the vehicle type.

Ensure that the mounting location of the child restraint system within the vehicle is correct, see following tables.

Allow children to enter and exit the vehicle only on the side facing away from the traffic.

When the child restraint system is not in use, secure the seat with a seat belt or remove it from the vehicle.

#### Notice

Do not affix anything on the child restraint systems and do not cover them with any other materials.

A child restraint system which has been subjected to stress in an accident must be replaced.

## Child restraint installation locations

### Permissible options for fitting a child restraint system

Weight and age class	On front passenger seat		On rear outboard seats	On rear centre seat
	activated airbag	deactivated airbag		
<b>Group 0: up to 10 kg</b> or approx. 10 months	X	U <sup>1</sup>	U <sup>2</sup>	U <sup>2</sup>
<b>Group 0+: up to 13 kg</b> or approx. 2 years	X	U <sup>1</sup>	U <sup>2</sup>	U <sup>2</sup>
<b>Group I: 9 to 18 kg</b> or approx. 8 months to 4 years	X	U <sup>1</sup>	U <sup>2</sup>	U <sup>2</sup>
<b>Group II: 15 to 25 kg</b> or approx. 3 to 7 years	X	X	U <sup>2</sup>	U <sup>2</sup>
<b>Group III: 22 to 36 kg</b> or approx. 6 to 12 years	X	X	U <sup>2</sup>	U <sup>2</sup>

<sup>1</sup> : if the child restraint system is being secured using a three-point seat belt, move seat height adjustment to uppermost position and ensure that vehicle seat belt runs forwards from the upper anchorage point. Adjust seat backrest inclination as far as necessary to a vertical position to ensure that the belt is tight on the buckle side.

<sup>2</sup> : move the head restraint to uppermost position. If it interferes with the proper installation of the child restraint system, remove the head restraint ↪ 34.

U : universal suitability in conjunction with three-point seat belt.

X : no child restraint system permitted in this weight class.

## Permissible options for fitting an ISOFIX child restraint system

Weight class	Size class	Fixture	On front passenger seat	On rear outboard seats	On rear centre seat
Group 0: up to 10 kg	E	ISO/R1	X	IL <sup>1</sup>	X
Group 0+: up to 13 kg	E	ISO/R1	X	IL <sup>1</sup>	X
	D	ISO/R2	X	IL <sup>1</sup>	X
	C	ISO/R3	X	IL <sup>1</sup>	X
Group I: 9 to 18 kg	D	ISO/R2	X	IL <sup>1</sup>	X
	C	ISO/R3	X	IL <sup>1</sup>	X
	B	ISO/F2	X	IL, IUF	X
	B1	ISO/F2X	X	IL, IUF	X
	A	ISO/F3	X	IL, IUF	X
Group II: 15 to 25 kg or approx. 3 to 7 years			X	IL	X
Group III: 22 to 36 kg or approx. 6 to 12 years			X	IL	X

- 
- <sup>1</sup> : move front passenger seat to the foremost position or adjust front seat backrest inclination as far as necessary to a vertical position to ensure that there is no interference between child restraint system and front seat backrest.
- IL : suitable for particular ISOFIX restraint systems of the "specific-vehicle", "restricted" or "semi-universal" categories. The ISOFIX restraint system must be approved for the specific vehicle type.
- IUF : suitable for ISOFIX forward-facing child restraint systems of universal category approved for use in this weight class.
- X : no ISOFIX child restraint system approved in this weight class.

### **ISOFIX size class and seat device**

- A – ISO/F3 : forward-facing child restraint system for children of maximum size in the weight class 9 to 18 kg
- B – ISO/F2 : forward-facing child restraint system for smaller children in the weight class 9 to 18 kg
- B1 – ISO/F2X : forward-facing child restraint system for smaller children in the weight class 9 to 18 kg
- C – ISO/R3 : rear-facing child restraint system for children of maximum size in the weight class up to 18 kg
- D – ISO/R2 : rear-facing child restraint system for smaller children in the weight class up to 18 kg
- E – ISO/R1 : rear-facing child restraint system for young children in the weight class up to 13 kg

## ISOFIX child restraint systems

### Installation of ISOFIX child restraint systems without permanent guide



Fasten vehicle-approved ISOFIX child restraint systems to the ISOFIX mounting brackets. Specific vehicle ISOFIX child restraint system positions are marked in the table by IL.



ISOFIX mounting brackets are indicated by a label on the backrest.

### Installation of ISOFIX child restraint systems with permanent guide



The vehicle might be equipped with guides in front of the mounting brackets to support the installation of the child restraint system.



The covers of the guides will swivel backwards automatically when attaching the child restraint system.

### Top-tether fastening eyes

Depending on country specific equipment, the vehicle might have two or three fastening eyes.

Top-Tether fastening eyes are marked with the symbol  for a child restraint.

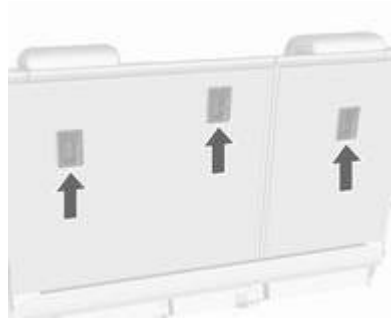

For non-ISOFIX child restraints, fasten the Top-Tether strap to the Top-Tether fastening eyes. The strap must run between the two guide rods of the head restraint.

For ISOFIX child restraints, fasten the Top-Tether strap to the Top-Tether fastening eyes in addition to the ISOFIX mounting. The strap must run between the two guide rods of the head restraint.

ISOFIX child restraint systems of universal category positions are marked in the table by IUF.

## Storage

<b>Storage compartments</b> .....	<b>54</b>
Instrument panel storage .....	54
Glovebox .....	55
Cupholders .....	55
Sunglasses storage .....	55
Underseat storage .....	56
Centre console storage .....	56
Rear carrier system .....	56
<b>Load compartment</b> .....	<b>65</b>
Load compartment cover .....	67
Rear floor storage cover .....	67
Lashing eyes .....	68
Warning triangle .....	68
First aid kit .....	68
<b>Roof rack system</b> .....	<b>68</b>
Roof rack .....	68
<b>Loading information</b> .....	<b>69</b>

## Storage compartments

### ⚠ Warning

Do not store heavy or sharp objects in the storage compartments. Otherwise, the storage compartment lid could open and vehicle occupants could be injured by objects being thrown around in the event of hard braking, a sudden change in direction or an accident.

## Instrument panel storage



A storage compartment is located next to the steering wheel.



A further storage compartment is located on top of the glovebox.

To open, push the button.

The covers of the storage compartments should be closed while driving.



## Glovebox

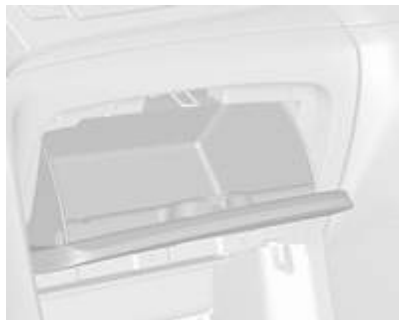

To open, pull the handle.  
The glovebox should be closed while driving.

## Cupholders



The cupholders are located in the centre console and rear part of the centre console.



To use the rear seat cupholder, pull the strap in the rear seat armrest.

## Sunglasses storage

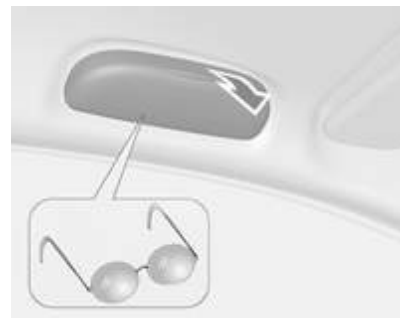

Fold down and open.  
Do not use for storing heavy objects.

## Underseat storage



Lift drawer at the front and pull out. To close, push the drawer in and engage.

## Centre console storage

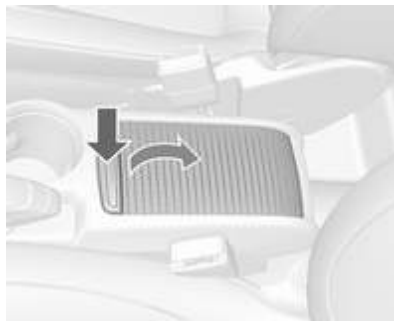

Push down the button and slide cover backwards.

## Rear carrier system

### Rear carrier system for three bicycles



The rear carrier system (Flex-Fix system) allows one bicycle to be attached to a pull-out carrier integrated into the vehicle floor. It is possible to attach two further bicycles on an adapter. The transportation of other objects is not permitted.

The maximum load of the rear carrier system is 60 kg with attached adapter and 30 kg without attached adapter. This allows the attachment of an

electrically-powered bicycle to the pull-out carrier. The maximum load per bicycle on the adapter is 20 kg. The wheelbase of a bicycle must not exceed 1.15 metres. Otherwise the secure fastening of a bicycle is not possible.

If not in use, the carrier system must be slid back into the vehicle floor.

There must not be any objects on the bicycles that could become loose during transportation.

### Caution

If the rear carrier system is extended and the vehicle is fully loaded, the chassis clearance will be reduced.

Drive carefully whenever the road has a strong inclination or when driving over a ramp, bump, etc.

### Caution

Consult your bicycle dealer before attaching bicycles with carbon frames. The bicycles may get damaged.

### Extending

Open the tailgate.

### ⚠ Warning

No-one should be in the extension zone of the rear carrier system, risk of injury.

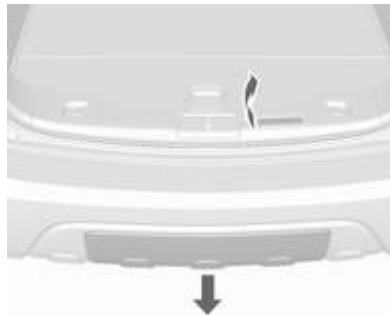

Pull release lever up. The rear carrier system disengages and travels quickly out of the rear bumper.



Completely pull out the rear carrier system until you hear it engage.

Ensure that it is not possible to push in the rear carrier system without pulling the release lever again.

### ⚠ Warning

It is only permissible to fit objects to the rear carrier system if the system has been correctly engaged. If the rear carrier system will not engage correctly, do not fit

objects to the system and slide the system back. Seek the assistance of a workshop.

### Unfold number plate holder



Lift the number plate holder and fold it backwards.

Affix the number plate before first usage of the rear carrier system.

### Fold out tail lamps

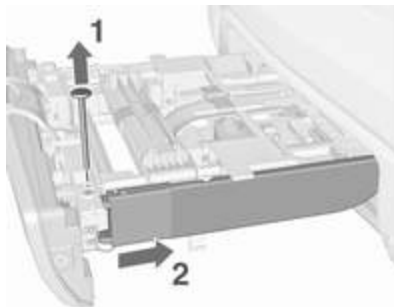

To install the tail lamps, remove both screws (1). Pull tail lamps out of the retainer to the front (2) and downwards and swivel them to the side.

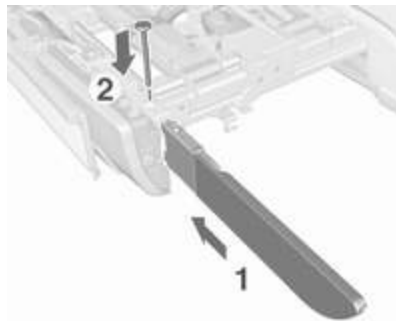

Push the tail lamps into the retainer (1) and reinstall screws (2) to fix the lamps.

### Fold out wheel recess



Remove strap and fold out the wheel recess.

### Lock the rear carrier system



Remove strap and swivel both clamping levers sideways as far as they will go.

Otherwise safe functionality is not guaranteed.

### Assembling the bicycle rack

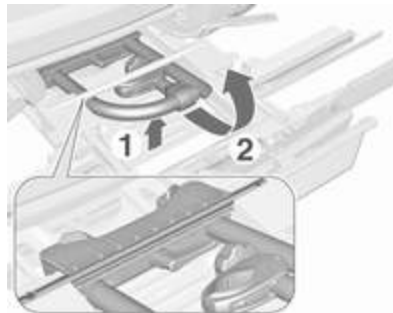

Lift the rack at the rear (1) and pull it backwards.

Fold up the rack (2).

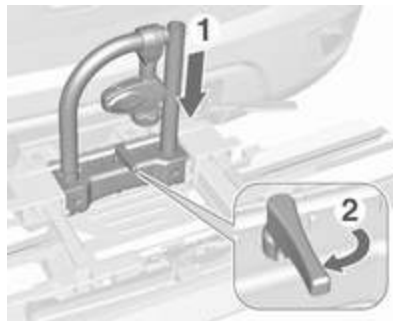

Push down the rack (1) and swivel handle (2) backwards to engage.



Press button (1) and remove left part of rack (2).

Press button (1) and insert left part of rack into the right part (2).



### Attaching a bicycle



1. Rotate the pedals into position, as shown in the illustration, and put the bicycle on the wheel recess.

Make sure that the bicycle stands centrally on the wheel recesses.



2. Attach the short mounting bracket to the bicycle frame. Turn the knob clockwise to fasten.



3. Secure both bicycle wheels to the wheel recesses using the strap retainers.
4. Check the bicycle to make sure it is secure.

### Caution

Ensure gap between bicycle and vehicle is at least 5 cm. If necessary, loosen handlebar and swivel sideways.

### Attaching the adapter

When carrying more than one bicycle, the adapter must be fixed.



1. Apply the adapter to the rear carrier system, as shown in the illustration.

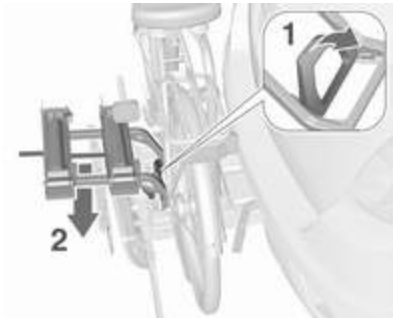

2. Turn the lever (1) forwards and hold, then lower the adapter (2) at the rear.
3. Release lever and check if the adapter is engaged securely.

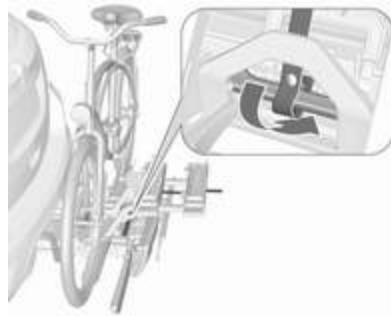

4. Guide the strap attached to the adapter underneath the lever when folding back the rear carrier system. Fasten the strap.

#### Attaching further bicycles

The attachment of further bicycles is similar to the attachment of the first bicycle. Additionally, some steps must be considered:

1. Before putting on the bicycle, always unfold the wheel recesses for the next bicycle if necessary.
2. Always rotate the pedals into an appropriate position before putting on the bicycle.

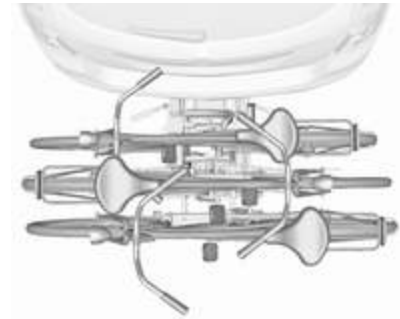

3. Position the bicycles on the rear carrier system alternately aligned to the left and to the right.
4. Align the bicycles to the one attached before. The wheel hubs of the bicycles must not touch each other.
5. Attach the bicycles with mounting brackets and strap retainers as described for the first bicycle. The mounting brackets should be fixed in parallel.

Use the long mounting bracket to attach the second bicycle to the rack.



Use the short accessory mounting bracket to attach the third bicycle. The bracket must be fixed between the frames of the second and third bicycle.



6. Additionally, secure both bicycle wheels of the third bicycle to the wheel recesses using the tensioning straps.

It is recommended to attach a warning sign at the rearmost bicycle, to increase visibility.

### Fold the rear carrier system backwards

The rear carrier system can be folded backwards to gain access to the load compartment.

- Without attached adapter:

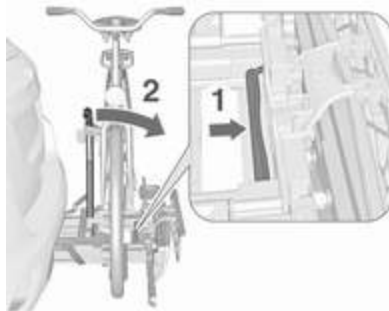

Push the lever (1) to disengage and hold.

Pull the rack (2) backwards to fold the rear carrier system.

- With attached adapter:

### ⚠ Warning

Take care when disengaging the rear carrier system as it will tilt backwards. Risk of injury.

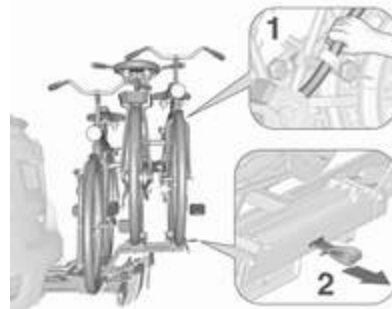

Hold frame (1) of rearmost bicycle with one hand and pull the loop (2) to disengage.

Hold rearmost bicycle with both hands and fold the rear carrier system backwards.



To increase visibility, the tail lights of the vehicle are activated when the rear carrier system is folded back.

### ⚠ Warning

When folding the rear carrier system forwards again, take care that the system is engaged securely.

### Removing bicycles

Undo strap retainers on both bicycle tyres.

Turn knob anticlockwise and remove mounting brackets.

### Detaching adapter

Detach the adapter before removing the bicycle on the rear carrier system.

1. Fold in wheel recesses.

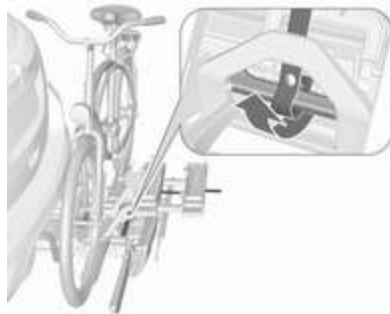

2. Unbutton the strap.

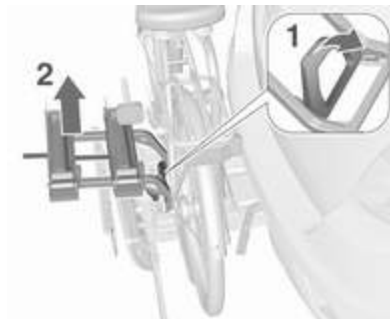

3. Turn the lever (1) forwards and hold.
4. Lift the adapter (2) at the rear and remove.

### Disassembling the bicycle rack



Press button (1) and remove upper part of rack (2).



Press button (1) and reinstall rack (2).

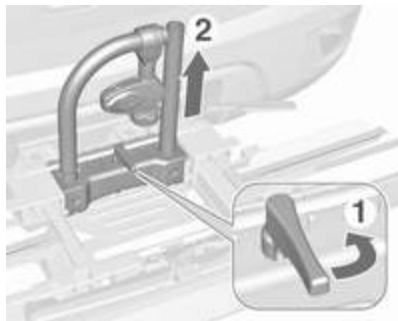

Arrange mounting brackets as shown in the illustration.

Swivel handle (1) sideways to disengage and lift the rack (2).



Fold the rack backwards, then push forwards until it stops (1).

Press the rack down at the rear (2).

#### Fold in wheel recess

Fold in wheel recess. Fasten strap.



Stow the strap retainers accurately.

#### Unlock the rear carrier system



Swivel both clamping levers inwards as far as they will go. Fasten strap.

#### Fold in tail lamps

Remove both screws. Pull tail lamps out of the retainer and swivel them forwards.

Push the tail lamps into the retainer and reinstall screws to fix the lamps

#### Fold in number plate holder

Lift the number plate holder and fold it forwards.

## Retracting the rear carrier system

### Caution

Take care that all foldable parts, e.g. wheel recesses and mounting brackets, are stowed accurately. Otherwise the rear carrier system may get damaged when trying to retract it.



Push the release lever up and hold. Lift the system slightly and push it into the bumper until it engages.

Release lever must return to original position.

### ⚠ Warning

If the system cannot be correctly engaged, please seek the assistance of a workshop.

## Load compartment

### Load compartment extension

### Caution

First fold down the rear seat cushion before folding the rear seat backrest.

Disregard may lead to damage to the rear seat.

1. Push head restraints down by pressing the catch.

### Notice

To ensure sufficient room for rear seat cushion operation, slide the front seat forward and move the front seat backrest upright.

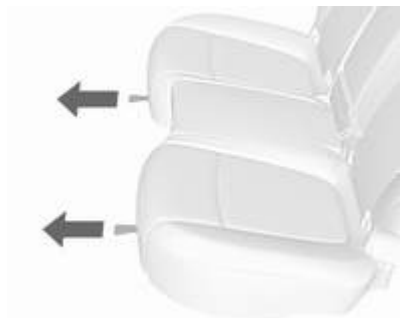

2. Pull the loop under the seat cushion and fold down the seat cushion.



3. Pull the release lever on top of the rear backrest.



4. Fold the backrest forward and down.



5. Put the seat belts for the outboard seats into the belt guides.

To return the backrest to the original position, pull out the seat belt from the belt guides and lift backrest up.

Push backrest firmly into place.

### **⚠ Warning**

When folding up, ensure that backrests are securely engaged in position before driving. Failure to do so may result in personal injury or damage to the load or vehicle in the event of hard braking or a collision.

Ensure the seat belts are not pinched by the latch.

The centre rear seat belt may lock when you raise the backrest. If this happens, allow the belt go back all the way and repeat operation.

If the seat belt is still locked, fold down the seat cushion and try again.

To return the rear seat cushion, put the rear part of the seat cushion in its original position ensuring that the seat belt buckle straps are not twisted

or caught under the seat cushion, then push the front part of the seat cushion firmly down until it latches.

### Caution

When returning rear seat backrest to the upright position, place the rear seat belt and buckles between the rear seat backrest and one cushion. Make sure the rear seat belt and buckles do not get pinched under the rear seat cushion.

Ensure the seat belts are not twisted or caught in the seat backrest and are arranged in their proper position.

## Load compartment cover



Do not place any objects on the cover.

## Removing

Unhook retaining straps from tailgate.

Lift cover at the rear and push it upwards at the front.

Remove the cover.

## Fitting

Engage cover in side guides and fold downwards.

Attach retaining straps to tailgate.

## Rear floor storage cover

### Rear floor cover



Grasp the handle and lift the cover.



Mount the cover to the hook at the sidewall.

## Lashing eyes

The lashing eyes are designed to secure items against slippage, e.g. using lashing straps or luggage net.

## Warning triangle



Stow the warning triangle below the floor cover in the load compartment. Secure it with the strap.

## First aid kit



Stow the first aid kit in the storage compartment at the left sidewall of the load compartment.

## Roof rack system

### Roof rack



The roof rack has side rails attached to the roof.

For safety reasons and to avoid damage to the roof, the vehicle approved roof rack system is recommended. For further information contact your workshop.

## Loading information

- Heavy objects in the load compartment should be placed against the seat backrests. Ensure the backrests are securely engaged. If objects can be stacked, the heavier objects should be placed at the bottom.
- Secure objects with lashing straps attached to the lashing eyes ↷ 68.
- Secure loose objects in load compartment to prevent sliding.
- When transporting objects in the load compartment, the backrests of the rear seats must not be angled forward.
- Do not allow the load to protrude above the upper edge of the backrests.
- Do not place any objects on the load compartment cover or the instrument panel, and do not cover the sensor on top of the instrument panel.

- The load must not obstruct the operation of the pedals, parking brake and gear selector, or hinder the freedom of movement of the driver. Do not place any unsecured objects in the interior.
- Do not drive with an open load compartment.

### Warning

Always make sure that the load in the vehicle is securely stowed. Otherwise objects can be thrown around inside the vehicle and cause personal injury or damage to the load or vehicle.

- The payload is the difference between the permitted gross vehicle weight (see identification plate ↷ 207) and the EC kerb weight.

To calculate the payload, enter the data for your vehicle in the weights table at the front of this manual.

The EC kerb weight includes weights for the driver (68 kg),

luggage (7 kg) and all fluids (fuel tank 90% full).

Optional equipment and accessories increase the kerb weight.

- Driving with a roof load increases the sensitivity of the vehicle to cross-winds and has a detrimental effect on vehicle handling due to the vehicle's higher centre of gravity.

Distribute the load evenly and secure it properly with retaining straps. Adjust the tyre pressure and vehicle speed according to the load conditions. Check and retighten the straps frequently.

Do not drive faster than 75 mph.

- The permissible roof load is 75 kg. The roof load is the combined weight of the roof rack and the load.

# Instruments and controls

<b>Controls</b> .....	<b>71</b>
Steering wheel adjustment .....	71
Steering wheel controls .....	71
Heated steering wheel .....	71
Horn .....	72
Windscreen wiper/washer .....	72
Rear window wiper/washer .....	74
Outside temperature .....	74
Clock .....	75
Power outlets .....	76
<b>Warning lights, gauges and indicators</b> .....	<b>77</b>
Speedometer .....	77
Odometer .....	77
Trip odometer .....	77
Tachometer .....	78
Fuel gauge .....	78
Fuel selector .....	78
Engine coolant temperature gauge .....	79
Service display .....	79
Control indicators .....	80
Turn signal .....	83
Seat belt reminder .....	83

Airbag and belt tensioners .....	83
Airbag deactivation .....	83
Charging system .....	84
Malfunction indicator light .....	84
Service vehicle soon .....	84
Brake and clutch system .....	84
Operate pedal .....	84
Antilock brake system (ABS) .....	84
Upshift .....	85
Descent control system .....	85
Power steering .....	85
Lane departure warning .....	85
Ultrasonic parking assist .....	85
Electronic Stability Control off .....	85
Electronic Stability Control and Traction Control system .....	86
Traction Control system off .....	86
Preheating .....	86
Diesel particle filter .....	86
Tyre pressure monitoring system .....	86
Engine oil pressure .....	86
Low fuel .....	87
Immobiliser .....	87
Exterior light .....	87
High beam .....	87
Adaptive forward lighting .....	87
Fog light .....	88
Rear fog light .....	88
Cruise control .....	88

Vehicle detected ahead .....	88
Bonnet open .....	88
Door open .....	88
<b>Information displays</b> .....	<b>88</b>
Driver Information Centre .....	88
Graphic-Info-Display, Colour-Info-Display .....	92
<b>Vehicle messages</b> .....	<b>93</b>
Warning chimes .....	95
Battery voltage .....	95
<b>Trip computer</b> .....	<b>96</b>
<b>Vehicle personalisation</b> .....	<b>99</b>
<b>OnStar</b> .....	<b>102</b>



## Controls

### Steering wheel adjustment



Unlock lever, adjust steering wheel, then engage lever and ensure it is fully locked.

Do not adjust steering wheel unless vehicle is stationary and steering wheel lock has been released.

### Steering wheel controls



The Infotainment system and the cruise control can be operated via the controls on the steering wheel.

Further information is available in the Infotainment manual.

Cruise control ↗ 139

### Heated steering wheel



Activate heating by pressing ☀. Activation is indicated by the LED in the button.

Heating is operational when the engine is running.

## Horn



Press .

## Windscreen wiper/washer

## Windscreen wiper



- HI** : fast  
**LO** : slow  
**INT** : interval wiping or automatic  
wiping with rain sensor  
**OFF** : off

For a single wipe when the windscreen wiper is off, press the lever down to position **1x**.  
Do not use if the windscreen is frozen.  
Switch off in car washes.

## Adjustable wiper interval



Wiper lever in position **INT**.

Turn the adjuster wheel to adjust the desired wipe interval:

- short interval : turn adjuster wheel upwards  
long interval : turn adjuster wheel downwards

## Automatic wiping with rain sensor



**INT** : automatic wiping with rain sensor

The rain sensor detects the amount of water on the windscreen and automatically regulates the frequency of the windscreen wiper.

## Adjustable sensitivity of the rain sensor



Turn the adjuster wheel to adjust the sensitivity:

- low sensitivity : turn adjuster wheel downwards
- high sensitivity : turn adjuster wheel upwards

Keep the sensor free from dust, dirt and ice.

## Windscreen washer

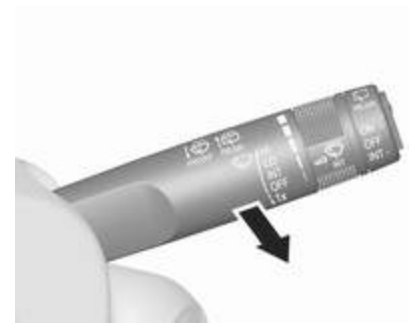

Pull lever. Washer fluid is sprayed onto the windscreen and the wiper wipes a few times.

Washer fluid ⇨ 167

## Rear window wiper/washer

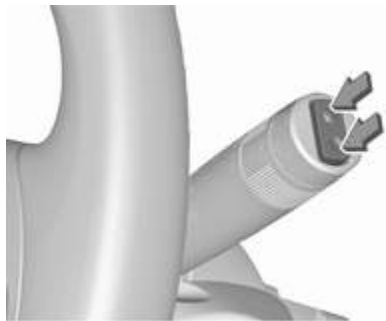

Press the rocker switch to activate the rear window wiper:

- upper switch : continuous operation
- lower switch : intermittent operation
- middle position : off



Push lever. Washer fluid is sprayed onto the rear window and the wiper wipes a few times.

Do not use if the rear window is frozen.

Switch off in car washes.

The rear window wiper comes on automatically when the windscreen wiper is switched on and reverse gear is engaged.

Activation or deactivation of this function can be changed in the menu **Settings** in the Info-Display.

Washer fluid ↻ 167

Vehicle personalisation ↻ 99.

## Outside temperature



A drop in temperature is indicated immediately and a rise in temperature after a time delay.

If outside temperature drops to 0.5 °C, a warning message is displayed in the Driver Information Centre with Uplevel-Display or Uplevel-Combi-Display.

### Warning

The road surface may already be icy even though the display indicates a few degrees above 0 °C.

## Clock

Date and time are shown in the Info-Display.

### Set date and time

#### CD 400

Press **CONFIG**. The menu **Settings** is displayed.

Select **Time Date**.

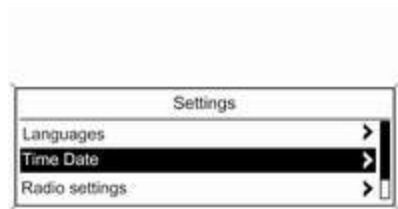

Selectable setting options:

- **Set time:** Changes the time shown on the display.
- **Set date:** Changes the date shown on the display.

- **Set time format:** Changes indication of hours between **12 h** and **24 h**.
- **Set date format:** Changes indication of date between **MM/DD/YYYY** and **DD/MM/YYYY**.
- **Display clock:** Switches on/off indication of time on the display.
- **RDS clock synchronization:** The RDS signal of most VHF transmitters automatically sets the time. RDS time synchronisation can take a few minutes. Some transmitters do not send a correct time signal. In such cases, it is recommended to switch off automatic time synchronisation.

Vehicle personalisation ⇨ 99.

### Time and date settings

#### CD 600/Navi 950

Press **CONFIG** and then select the **Time and Date** menu item to display the respective submenu.



#### Notice

If **RDS Auto Time Adjust** is activated, time and date are automatically set by the system.

See Infotainment manual for further information.

#### Set time

To adjust the time settings, select the **Set Time** menu item. Turn the multifunction knob to adjust the first setting.

Press the multifunction knob to confirm the input. The coloured background moves to the next setting.

Adjust all settings.

### Set date

To adjust the time settings, select the **Set Date** menu item. Turn the multifunction knob to adjust the first setting.

Press the multifunction knob to confirm the input. The coloured background moves to the next setting.

Adjust all settings.

### Time format

To choose the desired time format, select **12 hr / 24 hr Format**. Activate **12 Hour** or **24 Hour**.

Vehicle personalisation ⇨ 99.

### Power outlets



A 12 Volt power outlet is located in the front console.

A further 12 Volt power outlet may be located in the rear centre console.

Do not exceed the maximum power consumption of 120 watts.

Depending on equipment, a 230 Volt power outlet is located in the rear centre console.



Do not exceed the maximum power consumption of 150 watts.

With ignition off the power outlet is deactivated.

Additionally the power outlet is deactivated in the event of low battery voltage.

Electrical accessories that are connected must comply with the electromagnetic compatibility requirements laid down in DIN VDE 40 839.

### Caution

Do not connect any current delivering accessories, e.g. electrical charging devices or batteries.

Do not damage the outlets by using unsuitable plugs.

## Warning lights, gauges and indicators

### Speedometer



Indicates vehicle speed.

### Odometer



The bottom line displays the recorded distance.

### Trip odometer

The top line displays the recorded distance since the last reset.

To reset, press **SET/CLR** on the turn signal lever for a few seconds  
↺ 88.

Trip odometer counts up to a distance of 2000 miles then resets to 0.

## Tachometer



Displays the engine speed.

Drive in a low engine speed range for each gear as much as possible.

### Caution

If the needle is in the red warning zone, the maximum permitted engine speed is exceeded. Engine at risk.

## Fuel gauge



Displays the level in the fuel or gas tank depending on the operation mode.

The arrow indicates the vehicle side where the fuel filler flap is located.

Control indicator ● illuminates if the level in the tank is low. Refuel immediately if it flashes.

During liquid gas operation, the system automatically switches over to petrol operation when gas tanks are empty ⇄ 78.

Never run fuel tank dry.

Because of the fuel remaining in the tank, the top-up quantity may be less than the specified tank capacity.

## Fuel selector



Press **LPG** to switch between petrol and liquid gas operation. The LED in the button shows the current operating mode.



- LED off : petrol operation  
 LED flashes : checking conditions for fuel transition to liquid gas operation.  
 Illuminates if conditions are fulfilled.
- LED illuminates : liquid gas operation
- LED flashes five times and extinguishes : liquid gas tank is empty or failure in liquid gas system. A message is displayed in the Driver Information Centre.

As soon as the liquid gas tank is empty, petrol operation is automatically engaged until the ignition is switched off.

Fuel for liquid gas operation ↷ 152.

## Engine coolant temperature gauge



Displays the coolant temperature.

- left area : engine operating temperature not yet reached
- central area : normal operating temperature
- right area : temperature too high

### Caution

If engine coolant temperature is too high, stop vehicle, switch off engine. Danger to engine. Check coolant level.

### Service display

The engine oil life system lets you know when to change the engine oil and filter. Based on driving conditions, the interval at which an engine oil and filter change will be indicated can vary considerably.



In the Uplevel-Display and Uplevel-Combi-Display, the remaining oil life duration is displayed in the **Vehicle Information Menu**.

In the Midlevel-Display, the remaining engine oil life duration is displayed by control indicator , therefore the ignition must be switched on, with the engine off.

The menu and function can be selected via the buttons on the turn signal lever.

To display the remaining engine oil life duration:



Press **MENU** to select the **Vehicle Information Menu**.

Turn the adjuster wheel to select **Remaining Oil Life**.

The system must be reset every time the engine oil is changed to ensure proper functionality. Seek the assistance of a workshop.

Press **SET/CLR** to reset. Therefore the ignition must be switched on, with the engine off.

When the system has calculated that engine oil life has been diminished, **Change Engine Oil Soon** or a warning code appears in the Driver Information Centre. Have engine oil and filter changed by a workshop within one week or 300 miles (whichever occurs first).

Driver Information Centre  88.

Service information  204.

## Control indicators

The control indicators described are not present in all vehicles. The description applies to all instrument versions. Depending on the equipment, the position of the control indicators may vary. When the

ignition is switched on, most control indicators will illuminate briefly as a functionality test.

The control indicator colours mean:

- red : danger, important reminder
- yellow : warning, information, fault
- green : confirmation of activation
- blue : confirmation of activation
- white : confirmation of activation



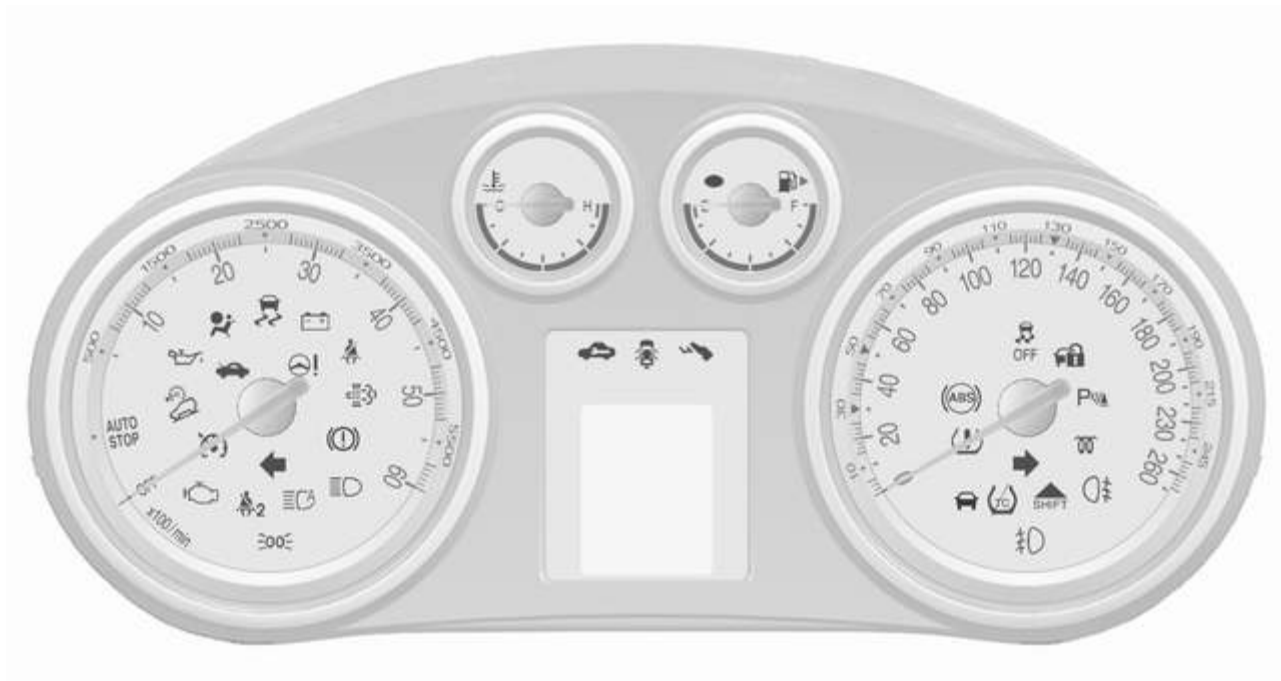

## Control indicators in the instrument cluster





























## Control indicators in the centre console



### Overview

-  Turn signal ⇨ 83
-  Seat belt reminder ⇨ 83
-  Airbag and belt tensioners ⇨ 83
-  Airbag deactivation ⇨ 83
-  Charging system ⇨ 84

-  Malfunction indicator light ⇨ 84
-  Service vehicle soon ⇨ 84
-  Brake and clutch system ⇨ 84
-  Operate pedal ⇨ 84
-  Antilock brake system (ABS) ⇨ 84
-  Upshift ⇨ 85
-  Descent control system ⇨ 85
-  Power steering ⇨ 85
-  Lane departure warning ⇨ 85
-  Ultrasonic parking assist ⇨ 85
-  Electronic Stability Control off ⇨ 85
-  Electronic Stability Control and Traction Control system ⇨ 86
-  Traction Control system off ⇨ 86
-  Preheating ⇨ 86
-  Diesel particle filter ⇨ 86
-  Tyre pressure monitoring system ⇨ 86
-  Engine oil pressure ⇨ 86
-  Low fuel ⇨ 87
-  Immobiliser ⇨ 87
-  Exterior light ⇨ 87
-  High beam ⇨ 87
-  Adaptive forward lighting ⇨ 87
-  Fog light ⇨ 88
-  Rear fog light ⇨ 88
-  Cruise control ⇨ 88
-  Vehicle detected ahead ⇨ 88

 Bonnet open ⇨ 88

 Door open ⇨ 88

## Turn signal

⇨ illuminates or flashes green.

### Illuminates briefly

The parking lights are switched on.

### Flashes

A turn signal or the hazard warning flashers are activated.

Rapid flashing: failure of a turn signal light or associated fuse, failure of turn signal light on trailer.

Bulb replacement ⇨ 171, Fuses ⇨ 178.

Turn signals ⇨ 112.

## Seat belt reminder

 for driver's seat illuminates or flashes red.

 for front passenger seat illuminates or flashes red when seat is occupied.

 for rear seats illuminate in the Driver Information Centre.

When the ignition is switched on, the control indicator illuminates for several seconds.

If seat belt becomes unfastened when the vehicle is moving, the control indicator illuminates.

If the seat belt is fastened, the control indicator extinguishes.

Three-point seat belts ⇨ 40.

## Airbag and belt tensioners

 illuminates red.

When the ignition is switched on, the control indicator illuminates for a few seconds. If it does not illuminate, does not go out after a few seconds or illuminates whilst driving, there is a fault in the airbag system. Seek the assistance of a workshop. The airbags and belt pretensioners may fail to trigger in the event of an accident.

Deployment of the belt pretensioners or airbags is indicated by continuous illumination of .

### Warning

Have the cause of the fault remedied immediately by a workshop.

Belt pretensioners, airbag system ⇨ 39, ⇨ 42.

## Airbag deactivation

 illuminates yellow.

The front passenger airbag is activated.

 illuminates yellow.

The front passenger airbag is deactivated ⇨ 47.

### Danger

Risk of fatal injury for a child using a child restraint system together with activated front passenger airbag.

Risk of fatal injury for an adult person with deactivated front passenger airbag.

## Charging system

 illuminates red.

Illuminates when the ignition is switched on and extinguishes shortly after the engine starts.

## Illuminates when the engine is running

Stop, switch off engine. Battery is not charging. Engine cooling may be interrupted. The brake servo unit may cease to be effective. Seek the assistance of a workshop.

## Malfunction indicator light

 illuminates or flashes yellow.

Illuminates when the ignition is switched on and extinguishes shortly after the engine starts.

## Illuminates when the engine is running

Fault in the emission control system. The permitted emission limits may be exceeded. Seek the assistance of a workshop immediately.

## Flashes when the engine is running

Fault that could lead to catalytic converter damage. Ease up on the accelerator until the flashing stops. Seek the assistance of a workshop immediately.

## Service vehicle soon

 illuminates yellow.

Additionally a warning message or a warning code is displayed.

The vehicle needs a service.

Seek the assistance of a workshop.

Vehicle messages ⇨ 93.

## Brake and clutch system

 illuminates red.

The brake and clutch fluid level is too low, when manual parking brake is not applied ⇨ 168.

## Warning

Stop. Do not continue your journey. Consult a workshop.

Illuminates when the manual parking brake is applied and ignition is switched on ⇨ 135.

## Operate pedal

 illuminates or flashes yellow.

## Illuminates

Clutch pedal must be depressed to start the engine in Autostop mode. Stop-start system ⇨ 126.

## Flashes

Clutch pedal must be depressed for a main start of the engine ⇨ 16, ⇨ 125.

## Antilock brake system (ABS)

 illuminates yellow.

Illuminates for a few seconds after the ignition is switched on. The system is ready for operation when the control indicator extinguishes.

If the control indicator does not extinguish after a few seconds, or if it illuminates while driving, there is a fault in the ABS. The brake system remains operational but without ABS regulation.

Antilock brake system ⇨ 135.

## Upshift

 illuminates green or is shown as a symbol in the Driver Information Centre with Uplevel-Display or Uplevel-Combi-Display when upshifting is recommended for fuel saving reasons.

ECO drive assistant ⇨ 96.

## Descent control system

 illuminates or flashes green.

Descent control system ⇨ 138

## Illuminates

The system is ready for operation.

## Flashes

The system is activated.

## Power steering

 illuminates yellow.

It illuminates when the ignition is switched on and extinguishes shortly after the engine starts.

If the indicator does not extinguish after a few seconds, or if it illuminates while driving, there is a failure in the power steering system.

Seek the assistance of a workshop.

## Lane departure warning

 illuminates green or yellow or flashes yellow.

## Illuminates green

System is switched on and ready to operate.

## Illuminates yellow

Failure in the system. Seek the assistance of a workshop.

## Flashes yellow

System recognises an unintended lane change.

## Ultrasonic parking assist

 illuminates yellow.

Fault in system

or

Fault due to sensors that are dirty or covered by ice or snow

or

Interference due to external sources of ultrasound. Once the source of interference is removed, the system will operate normally.

Have the cause of the fault in the system remedied by a workshop.

Ultrasonic parking assist ⇨ 143.

## Electronic Stability Control off

 illuminates yellow.

The system is deactivated.

## Electronic Stability Control and Traction Control system

 illuminates or flashes yellow.

### Illuminates

A fault in the system is present. Continued driving is possible. Driving stability, however, may deteriorate depending on road surface conditions.

Have the cause of the fault remedied by a workshop.

### Flashes

The system is actively engaged. Engine output may be reduced and the vehicle may be braked automatically to a small degree.

Electronic Stability Control ⇨ 137, Traction Control system ⇨ 136.

## Traction Control system off

 illuminates yellow.

The system is deactivated.

## Preheating

 illuminates yellow.

Preheating of diesel engine is activated. Only activates when outside temperature is low.

## Diesel particle filter

 illuminates or flashes yellow.

The diesel particle filter requires cleaning.

Continue driving until  extinguishes. If possible, do not allow engine speed to drop below 2000 rpm.

### Illuminates

The diesel particle filter is full. Start cleaning process as soon as possible.

### Flashes

The maximum filling level of the filter is reached. Start cleaning process immediately to avoid damage to the engine.

Diesel particle filter ⇨ 129, Stop-start system ⇨ 126.

## Tyre pressure monitoring system

 illuminates or flashes yellow.

### Illuminates

Tyre pressure loss. Stop immediately and check tyre pressure.

### Flashes

Fault in system or tyre without pressure sensor mounted (e.g. spare wheel). After 60-90 seconds the control indicator illuminates continuously. Consult a workshop.

Tyre pressure monitor system ⇨ 185.

## Engine oil pressure

 illuminates red.

Illuminates when the ignition is switched on and extinguishes shortly after the engine starts.



## Illuminates when the engine is running

### Caution

Engine lubrication may be interrupted. This may result in damage to the engine and/or locking of the drive wheels.

1. Depress clutch.
2. Select neutral gear, set selector lever to **N**.
3. Move out of the flow of traffic as quickly as possible without impeding other vehicles.
4. Switch off ignition.

### ⚠ Warning

When the engine is off, considerably more force is needed to brake and steer. During an Autostop the brake servo unit will still be operational.

Do not remove key until vehicle is stationary, otherwise the steering wheel lock could engage unexpectedly.

Check oil level before seeking the assistance of a workshop ⇨ 165.

## Low fuel

● illuminates or flashes yellow.

## Illuminates

Level in fuel tank is too low.

## Flashes

Fuel used up. Refuel immediately. Never run the tank dry.

Refuelling ⇨ 154.

Catalytic converter ⇨ 130.

Bleeding the diesel fuel system ⇨ 170.

## Immobiliser

🔒 flashes yellow.

Fault in the immobiliser system. The engine cannot be started.

Have the cause of the fault remedied by a repairer.

## Exterior light

➤⚡ illuminates green.

The exterior lights are on ⇨ 106.

## High beam

≡D illuminates blue.

Illuminates when high beam is on or during headlight flash ⇨ 107, or when high beam is on with high beam assist, adaptive forward lighting ⇨ 109.

## Adaptive forward lighting

⚡ illuminates or flashes yellow.

## Illuminates



The adaptive forward lighting system needs a service.

Seek the assistance of a workshop.

Adaptive forward lighting ⇨ 109.

## Flashes

System switched to symmetrical low beam.

Control indicator  flashes for approx. 4 seconds after the ignition is switched on as a reminder that the system has been activated  108.

Automatic light control  107.

## Fog light

 illuminates green.

The front fog lights are on  112.

## Rear fog light

 illuminates yellow.

The rear fog light is on  112.

## Cruise control

 illuminates white or green.

### Illuminates white

The system is on.

### Illuminates green

Cruise control is active.

Cruise control  139.

## Vehicle detected ahead

 illuminates green.

A vehicle ahead is detected in the same lane.

Forward collision alert  141.

## Bonnet open

 illuminates when the bonnet is open on vehicles with stop-start system.

Stop-start system  126.

## Door open

 illuminates red.

A door or the tailgate is open.

## Information displays

### Driver Information Centre

The Driver Information Centre is located in the instrument cluster between speedometer and tachometer. It is available as Midlevel-Display, Uplevel-Display or Uplevel-Combi-Display.



Midlevel-Display indicates:

- overall odometer
- trip odometer
- some control indicators
- vehicle information

- trip/fuel information
- vehicle messages, displayed as code numbers ↪ 93

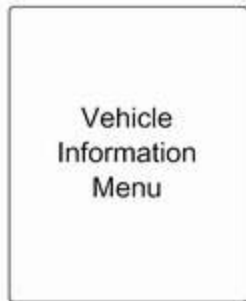

In the Uplevel-Display the following main menus can be selected by pressing **MENU** on the turn signal lever:

- **Vehicle Information Menu**
- **Trip/Fuel Information Menu**



In the Uplevel-Combi-Display, menu pages can be selected by pressing **MENU** on the turn signal lever. Menu symbols are indicated in the top line of the display:

- **Vehicle Information Menu**
- **Trip/Fuel Information Menu**
- **ECO ECO Information Menu**

Some of the displayed functions differ when the vehicle is being driven or at a standstill. Some functions are only available when the vehicle is being driven.

Vehicle personalisation ↪ 99.  
Memorised settings ↪ 21.

## Selecting menus and functions

The menus and functions can be selected via the buttons on the turn signal lever.



Press **MENU** to switch between the menus or to return from a submenu to the next higher menu level.



Turn the adjuster wheel to highlight a menu option or to set a numeric value.



Press **SET/CLR** to select a function or to confirm a message.

### Vehicle Information Menu

Press **MENU** to select the **Vehicle Information Menu**, or on Uplevel-Combi-Display select .

Turn the adjuster wheel to select a submenu. Press **SET/CLR** to confirm.

Follow the instructions given in the submenus.

Possible submenus can be, depending on version:

- **Unit:** displayed units can be changed
- **Tyre Pressure System:** checks tyre pressure of all wheels during driving ↻ 185
- **Tyre Load:** select tyre pressure category according to the actual tyre inflation pressure ↻ 185
- **Remaining Oil Life:** indicates when to change the engine oil and filter ↻ 79
- **Traffic Sign Assistant:** displays detected traffic signs for the current route section ↻ 147
- **Speed Warning:** if exceeding the preset speed a warning chime will be activated

Selection and indication can be different between Midlevel-Display, Uplevel-Display and Uplevel-Combi-Display.

### Trip/Fuel Information Menu

Press **MENU** to select the **Trip/Fuel Information Menu**, or select  on Uplevel-Combi-Display.

Turn the adjuster wheel to select a submenu. Press **SET/CLR** to confirm.

- trip odometer 1
- trip odometer 2
- digital speed

Trip odometer 2 and digital speed are only available on vehicles with Uplevel-Display or Uplevel-Combi-Display.

On vehicles with trip computer more submenus are available.

Selection and indication can be different between Midlevel-, Uplevel-, and Uplevel-Combi-Display.

Trip/Fuel Information Menu, Trip Computer ↻ 96.

## ECO Information Menu

Press **MENU** to select **ECO** in the top line of the Uplevel-Combi-Display.

Turn the adjuster wheel to select a submenu. Press **SET/CLR** to confirm.

Submenus are:

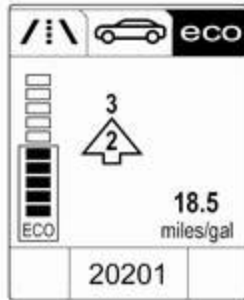

- **Shift indication:** Current gear is indicated inside an arrow. The illustration above recommends upshifting for fuel saving reasons.

**Eco index display:** The current fuel consumption is indicated on a segment display. For economical driving, adapt your driving style to keep the filled

segments within the Eco area. The more segments are filled, the higher the fuel consumption. Simultaneously the current consumption value is indicated.



- **Top Consumers:** List of top comfort consumers currently switched on is displayed in descending order. Fuel saving potential is indicated. A switched-off consumer disappears from the list and the consumption value will be updated.

During sporadic driving conditions, the heated rear window is activated automatically to increase engine load. In this

event, the heated rear window is indicated as one of the top consumers, without activation by the driver.



- **Economy Trend:** Displays the average consumption development over a distance of 50 miles. Filled segments display the consumption in 5 mile steps and shows the effect of topography or driving behaviour on fuel consumption.

## Graphic-Info-Display, Colour-Info-Display

Depending on the vehicle configuration the vehicle has a Graphic-Info-Display or Colour-Info-Display. The Info-Display is located in the instrument panel above the Infotainment system.

### Graphic-Info-Display



Graphic-Info-Display indicates:

- time ↷ 75
- outside temperature ↷ 74
- date ↷ 75

- Infotainment system, see description in the Infotainment manual
- settings for vehicle personalisation ↷ 99

### Colour-Info-Display



The Colour-Info-Display indicates in colour:

- time ↷ 75
- outside temperature ↷ 74
- date ↷ 75
- Infotainment system, see description in the Infotainment manual

- navigation, see description in the Infotainment manual
- system settings
- vehicle messages ↷ 93
- settings for vehicle personalisation ↷ 99

The type of information and how it is displayed depends on the equipment of the vehicle and the settings made.

### Selecting menus and settings

Menus and settings are accessed via the display.

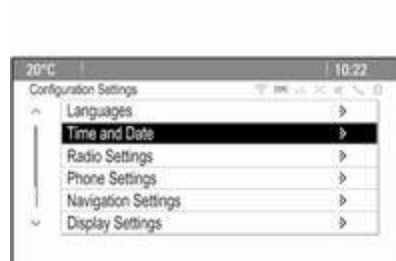

Selections are made via:

- menus
- function buttons and multifunction knob of the Infotainment system

### Selecting with the Infotainment system



Select a function via the Infotainment system buttons. The menu of the selected function is displayed.

The multifunction knob is used to select an item and to confirm.

### Multifunction knob

The multifunction knob is the central control element for the menus:

#### Turn

- to mark a menu option
- to set a numeric value or to display a menu option

#### Press (the outer ring)

- to select or activate the marked option
- to confirm a set value
- to switch a system function on/off

### BACK

Press **BACK** to:

- exit a menu without changing settings
- return from a submenu to a higher menu level
- delete the last character in a character sequence

Press and hold **BACK** for a few seconds to delete the entire entry.

Vehicle personalisation ⇨ 99.

## Vehicle messages

Messages are indicated mainly in the Driver Information Centre, in some cases together with a warning chime.



Press **SET/CLR**, **MENU** or turn the adjuster wheel to confirm a message.

### Vehicle messages on the Midlevel-Display



The vehicle messages are displayed as code numbers.

No.	Vehicle message
10	Brakes overheated
16	Brake light failure
25	Left front turn signal failure
26	Left rear turn signal failure
27	Right front turn signal failure
28	Right rear turn signal failure

No.	Vehicle message
53	Tighten fuel filler cap
54	Water in diesel fuel filter
S68	Service power steering
S73	Service all-wheel drive system
S75	Service air conditioning
S79	Top up engine oil
S81	Service transmission
S82	Change engine oil soon
S84	Engine power is reduced
S89	Service vehicle soon
128	Bonnet open
134	Parking assist fault, clean bumper
S136	Service parking assist
174	Low battery

**Notice**

"S" means "Service vehicle soon". Seek the assistance of a workshop immediately.

### Vehicle messages on the Uplevel-Display and Uplevel-Combi-Display



The vehicle messages are displayed as text. Follow the instructions given in the messages.

The system displays messages regarding the following topics:

- service messages
- anti-theft alarm system
- brakes
- drive systems
- ride control systems
- driver assistance systems



- cruise control
- speed limiter
- parking assist systems
- lighting, bulb replacement
- adaptive forward lighting
- doors, windows
- traffic sign assistant
- lane departure warning
- load compartment, boot lid
- radio remote control
- seat belts
- airbag systems
- engine and transmission
- tyre pressure
- diesel particle filter
- vehicle battery status

## Warning chimes

### When starting the engine or whilst driving

Only one warning chime will sound at a time.

The warning chime regarding unfastened seat belts has priority over any other warning chime.

- If the door or bonnet is open.
- If seat belt is not fastened.
- If a certain speed is exceeded with parking brake applied.
- If a warning message or a warning code appears in the Driver Information Centre.
- If the parking assist detects an object.
- If the fuel level is low.

### When the vehicle is parked and/or the driver's door is opened

- With exterior lights on.

### During an Autostop

- If the driver's door is opened.

## Battery voltage

When the battery voltage is running low, a warning message or warning code 174 will appear in the Driver Information Centre.

1. Switch off immediately any electrical consumers which are not required for a safe ride, e.g. seat heating, heated rear window or other main consumers.
2. Charge the battery by driving continuously for a while or by using a charging device.

The warning message or warning code will disappear after the engine has been started twice consecutively without a voltage drop.

If the battery cannot be recharged, have the cause of the fault remedied by a workshop.

## Trip computer

The menus and functions can be selected via the buttons on the turn signal lever ⇨ 88.



Press **MENU** to select the **Trip/Fuel Information Menu**, or select **/:\** on the Uplevel-Combi-Display.



### Trip/Fuel Information Menu on Uplevel-Display

Turn the adjuster wheel to select one of the submenus:



- trip odometer 1
- trip odometer 2
- range
- average consumption
- instantaneous consumption
- average speed
- digital speed
- traffic sign assistant
- route guidance

### Trip/Fuel Information Menu on Uplevel-Combi-Display

Turn the adjuster wheel to select the submenus:



- trip odometer 1

- average consumption 1
- average speed 1



- trip odometer 2
- average consumption 2
- average speed 2



- digital speed
- range
- instantaneous consumption
- route guidance

### Trip computer 1 and 2

The information of two trip computers can be reset separately for odometer, average consumption and average speed by pressing **SET/CLR**, making it possible to display different trip information for different drivers.



### Trip odometer

Trip odometer displays the recorded distance since a certain reset.

Trip odometer counts up to a distance of 2000 miles and then restarts at 0.

To reset, press **SET/CLR** for a few seconds.

### Range

Range is calculated from current fuel tank level and current consumption. The display shows average values.

After refuelling, the range is updated automatically after a brief delay.

When the fuel level in the tank is low, a message appears on vehicles with Uplevel-Display or Uplevel-Combi-Display.

When the tank must be refuelled immediately, a warning code or warning message is displayed on vehicles with Midlevel- and Uplevel-Display or Uplevel-Combi-Display.

Additionally, the control indicator ● in the fuel gauge illuminates or flashes ⇨ 87.

### Range LPG version

On vehicles with LPG engines and Uplevel-Display: Display of approximate range available with the remaining fuel in each respective fuel tank of petrol and LPG fuel, along with a total range of both fuel types together. Switch between the modes by pressing **SET/CLR**.

### Average consumption

Display of average consumption. The measurement can be reset at any time and starts with a default value.

To reset, press **SET/CLR** for a few seconds.

On vehicles with LPG engines and Uplevel-Display: Average consumption is indicated for the currently selected mode (LPG or petrol).

### Instantaneous consumption

Display of the instantaneous consumption.

On vehicles with LPG engines and Uplevel-Display: Instantaneous consumption is indicated for the currently selected mode (LPG or petrol).

### Average speed

Display of average speed. The measurement can be reset at any time.

To reset, press **SET/CLR** for a few seconds.

### Digital speed

Digital display of the instantaneous speed.

### Route guidance

Additional to the navigation information in the Colour-Info-Display, route guidance is displayed in the Driver Information Centre.

## Vehicle personalisation

The vehicle's behaviour can be personalised by changing the settings in the Info-Display.

Depending on vehicle equipment some of the functions described below may not be available.

Some functions are only displayed or active when the engine is running.

### Settings in the Graphic-Info-Display

#### CD 400

Press **CONFIG**. The Settings menu is displayed.

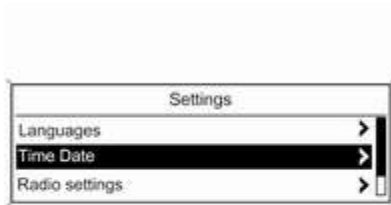

The following settings can be selected by turning and pressing the multifunction knob:

- **Languages**
- **Time Date**
- **Radio settings**
- **Bluetooth settings**
- **Vehicle settings**

In the corresponding submenus the following settings can be changed:

#### Languages

Selection of the desired language.

#### Time Date

See 'Clock' ⇨ 75.

#### Radio settings

See Infotainment manual for further information.

#### Bluetooth settings

See Infotainment manual for further information.

#### Vehicle settings

- **Climate and air quality**

**Auto fan speed:** Modifies the speed fan regulation. Changed setting will be active after

switching the ignition off and on again.

**Climate control mode:** Activates or deactivates cooling.

**Auto demist:** Supports windscreen dehumidification by automatically selecting the necessary settings and auto air conditioning mode.

**Auto rear demist:** Automatic activation of the heated rear window.

- **Comfort settings**

**Chime volume:** Changes the volume of warning chimes.

#### Personalization by driver:

Activates or deactivates the personalisation function.

#### Rear auto wipe in reverse:

Activates or deactivates automatic switching on of the rear window wiper when reverse gear is engaged.

- **Exterior ambient lighting**

#### Exterior lighting by unlocking:

Activates or deactivates the entry lighting.

**Duration upon exit of vehicle:**

Activates or deactivates and changes the duration of exit lighting.

- **Power door locks**

**Auto door lock:** Activates or deactivates the automatic door unlocking function after switching off ignition. Activates or deactivates the automatic door locking function after driving-off.

**Stop door lock if door open:** Activates or deactivates the automatic door locking function while a door is open.

**Delayed door lock:** Activates or deactivates the delayed door locking function.

- **Remote locking, unlocking, starting**

**Remote unlock feedback:** Activates or deactivates the hazard warning flasher feedback whilst unlocking.

**Remote door unlock:** Changes the configuration to unlock only

the driver's door or the whole vehicle whilst unlocking.

- **Restore factory settings:** Resets all settings to the default settings.

### Settings in the Colour-Info-Display

**CD 600/Navi 650/Navi 950**

Press **CONFIG** on the Infotainment system faceplate to enter the Configuration menu.

Turn the multifunction knob to scroll upwards or downwards in the list. Press the multifunction knob (Navi 950 / Navi 650: press the outer ring) to select a menu item.

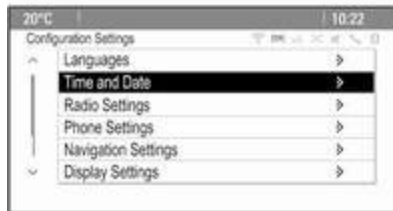

- **Languages**
- **Time and Date**
- **Radio Settings**
- **Phone Settings**
- **Navigation Settings**
- **Display Settings**
- **Vehicle Settings**

In the corresponding submenus the following settings can be changed:

**Languages**

Selection of the desired language.

**Time and Date**

See Infotainment manual for further information.

### Radio Settings

See Infotainment manual for further information.

### Phone Settings

See Infotainment manual for further information.

### Navigation Settings

See Infotainment manual for further information.

### Display Settings

- **Home Page Menu:**

See Infotainment manual for further information.

- **Rear Camera Options:**

Press to adjust the rear camera options ⇨ 145.

- **Display Off:**

See Infotainment manual for further information.

- **Map Settings:**

See Infotainment manual for further information.

### Vehicle Settings

- **Climate and Air Quality**

**Auto Fan Speed:** Modifies the fan speed regulation. Changed

setting will be active after switching the ignition off and on again.

**Air Conditioning Mode:** Activates or deactivates cooling when switching on the ignition or uses the last chosen setting.

**Auto Demist:** Activates or deactivates auto demist.

**Auto Rear Demist:** Activates the heated rear window automatically.

- **Comfort and Convenience**

**Chime Volume:** Changes the volume of warning chimes.

**Personalisation by Driver:** Activates or deactivates the personalisation function.

**Auto Reverse Gear Wiper:** Activates or deactivates automatic switching on of the rear window wiper when reverse gear is engaged.

- **Collision Detection Systems**

**Park Assist:** Activates or deactivates the ultrasonic sensors.

- **Lighting**

**Vehicle Locator Lights:** Activates or deactivates the entry lighting.

**Exit Lighting:** Activates or deactivates and changes the duration of exit lighting.

- **Power Door Locks**

**Open Door Anti Lock Out:** Activates or deactivates the automatic door locking function while a door is open.

**Auto Door Lock:** Activates or deactivates the automatic door unlocking function after switching off ignition. Activates or deactivates the automatic door locking function after driving-off.

**Delay Door Lock:** Activates or deactivates the delayed door locking function.

- **Remote Lock/Unlock/Start**

**Remote Lock Feedback:** Activates or deactivates the hazard warning light feedback whilst locking.

**Remote Unlock Feedback:** Activates or deactivates the

hazard warning flasher feedback whilst unlocking.

**Remote Door Unlock:** Changes the configuration to unlock only the driver's door or the entire vehicle whilst unlocking.

**Relock Remotely Unlocked Doors:** Activates or deactivates the automatic relock function after unlocking without opening the vehicle.

- **Return to Factory Settings?:** Resets all settings to the default settings.

## OnStar

OnStar is a personal connectivity and service assistant with integrated Wi-Fi hotspot. The OnStar service is available 24 hours a day, seven days a week.

### Notice

OnStar is not available for all markets. For further information, contact your workshop.

### Notice

In order to be available and operational, OnStar needs a valid OnStar subscription, functioning vehicle electrics, mobile service and GPS satellite link.

To activate the OnStar services and set up an account, press  and speak with an advisor.

Depending on the equipment of the vehicle, the following services are available:

- Emergency services and support in the case of a vehicle breakdown
- Wi-Fi hotspot

- Smartphone application
- Remote control, e.g. location of the vehicle, activation of horn and lights, control of central locking system
- Stolen vehicle assistance
- Vehicle diagnostics
- Destination download

### Notice

The OnStar module of the vehicle is deactivated after ten days without an ignition cycle. Functions requiring a data connection will be available again after switching on the ignition.

## OnStar buttons







**Notice**

Depending on the equipment, the OnStar buttons can also be integrated in the rear view mirror.

**Privacy button**

Press and hold  until a message is heard to activate or deactivate the transmission of the vehicle location.

Press  to answer a call or to end a call to an advisor.

Press  to access the Wi-Fi settings.

**Service button**

Press  to establish a connection to an advisor.

**SOS button**

Press  to establish a priority emergency connection to a specially trained emergency advisor.

**Status LED**

Green: The system is ready.

Green flashing: The system is on a call.

Red: A problem arose.

Off: System is in standby mode.

Red / green flashing for a short period of time: Transmission of the vehicle location has been deactivated.

**OnStar services****General services**

If you need any information concerning e.g. opening hours, points of interest and destinations or if you need any support e.g. in the case of a vehicle breakdown, a flat tyre and empty fuel tank, press  to establish a connection to an advisor.

**Emergency services**

In the case of an emergency situation, press  and talk to an advisor. The advisor then contacts emergency or assistance service providers and directs them to your vehicle.

In the case of an accident with activation of airbags or belt tensioners, an automatic emergency call is established. The advisor is immediately connected to your vehicle to see whether help is needed.

**Wi-Fi hotspot**

The Wi-Fi hotspot of the vehicle provides internet connectivity with a maximum speed of 4G/LTE.

**Notice**

The Wi-Fi hotspot functionality is not available for all markets.

Up to seven devices may be connected.

To connect a mobile device with the Wi-Fi hotspot:

1. Press  and then select Wi-Fi settings on the Info-Display. The settings displayed include the Wi-Fi hotspot name (SSID), password and connection type.
2. Start a Wi-Fi network search on your mobile device.
3. Select your vehicle hotspot (SSID) when listed.
4. When prompted, enter the password on your mobile device.

### Notice

To change the SSID or password, press  and talk to an advisor or log in to your account.

To switch off the Wi-Fi hotspot functionality, press  to call an advisor.

### Smartphone app

With the My Vauxhall smartphone app, some vehicle functions can be operated remotely.

The following functions are available:

- Lock or unlock vehicle.
- Honk horn or flash lights.
- Check fuel level, engine oil life and tyre pressure (only with tyre pressure monitoring system).
- Send navigation destination to the vehicle, if equipped with a built-in navigation system.
- Locate vehicle on a map.
- Manage Wi-Fi settings.

To operate these functions, download the app from Apple's App Store or Google Play Store.

### Remote control

If desired, use any phone to call an advisor, who can remotely operate specific vehicle functions. Find the respective OnStar phone number on our country-specific website.

The following functions are available:

- Lock or unlock vehicle.
- Provide information on the vehicle location.
- Honk horn or flash lights.

### Stolen vehicle assistance

If the vehicle is stolen, report the theft to the authorities and request OnStar stolen vehicle assistance. Use any phone to call an advisor. Find the respective OnStar phone number on our country-specific website.

OnStar can provide support in locating and recovering the vehicle.

### Theft alert

When the anti-theft alarm system is triggered, a notification is sent to OnStar. You are then informed about this event by text message or email.

### Restart prevention

By sending remote signals, OnStar can prevent the vehicle from restarting once it has been turned off.

### On-demand diagnostics

At any time e.g. if the vehicle displays a vehicle message, press  to contact an advisor and ask to complete a real-time diagnostic check to directly determine the issue. Depending on the results, the advisor will provide further support.

### Diagnostic report

The vehicle automatically transmits diagnostic data to OnStar which sends a monthly email report to you and your preferred workshop.

### Notice

The workshop notification function can be disabled in your account.

The report contains the status of key operating systems of the vehicle like engine, transmission, airbags, ABS, and other major systems. It also provides information on possible

maintenance items and tyre pressure (only with tyre pressure monitoring system).

To look at the information in greater detail, select the link within the email and log in to your account.

### **Destination download**

A desired destination can be directly downloaded to the navigation system.

Press  to call an advisor and describe the destination or point of interest.

The advisor can look up any address or point of interest and directly send the destination to the built-in navigation system.

### **OnStar settings**

#### **OnStar PIN**

To have full access to all OnStar services, a four-digit PIN is required. The PIN has to be personalised when first talking to an advisor.

To change the PIN, press  to call an advisor.

#### **Account data**

An OnStar subscriber has an account where all the data is stored. To request a change of the account information, press  and talk to an advisor or log in to your account.

If the OnStar service is used on another vehicle, press  and request that the account be transferred to the new vehicle.

#### **Notice**

In any case, if the vehicle is disposed of, sold or otherwise transferred, immediately inform OnStar about the changes and terminate the OnStar service on this vehicle.

#### **Vehicle location**

The vehicle location is transmitted to OnStar when service is requested or triggered. A message on the Info-Display informs about this transmission.

To activate or deactivate the transmission of the vehicle location, press and hold  until an audio message is heard.

The deactivation is indicated by the status light flashing red and green for a short period of time and each time the vehicle is started.

#### **Notice**

If the transmission of the vehicle location is deactivated, some services are no longer available.

#### **Notice**

The vehicle location always remains accessible to OnStar in the case of an emergency.

Find the privacy policy in your account.

#### **Software updates**

OnStar may remotely carry out software updates without further notice or consent. These updates are to enhance or maintain safety and security or the operation of the vehicle.

These updates may concern privacy issues. Find the privacy policy in your account.

## Lighting

<b>Exterior lighting</b> .....	<b>106</b>
Light switch .....	106
Automatic light control .....	107
High beam .....	107
Headlight flash .....	108
Headlight range adjustment ....	108
Headlights when driving abroad .....	108
Daytime running lights .....	109
Adaptive forward lighting .....	109
Hazard warning flashers .....	111
Turn and lane-change signals .	112
Front fog lights .....	112
Rear fog light .....	112
Reversing lights .....	112
Misted light covers .....	113
<b>Interior lighting</b> .....	<b>113</b>
Instrument panel illumination control .....	113
Interior lights .....	113
Reading lights .....	114
Glove box lighting .....	114
Sunvisor lights .....	114
<b>Lighting features</b> .....	<b>114</b>
Entry lighting .....	114

Exit lighting .....	115
Battery discharge protection ....	115

## Exterior lighting

### Light switch



Turn light switch:

- O** : lights off
- ☞☞** : sidelights
- ☞D** : low beam

Control indicator ☞☞☞ 87.

## Light switch with Automatic light control



Turn light switch:

- AUTO** : automatic light control: exterior lighting is switched on and off automatically depending on external lighting conditions
- ☀ : activation or deactivation of the automatic light control. Switch turns back to **AUTO**
- ☞☜ : sidelights
- ☞☜☞☜ : low beam

## Tail lights

Tail lights are illuminated together with low beam and sidelights.

## Automatic light control



When the automatic light control function is switched on and the engine is running, the system switches between daytime running light and low beam automatically, depending on the lighting conditions. Daytime running light ↷ 109.

## Automatic headlight activation

During poor lighting conditions the low beam is switched on.

## Tunnel detection

When a tunnel is entered the low beam is switched on.

Adaptive forward lighting ↷ 109.

## High beam



To switch from low to high beam, push lever.

To switch to low beam, push lever again or pull.

## Headlight flash

To activate the headlight flash, pull lever.

## Headlight range adjustment

### Manual headlight range adjustment



To adapt headlight range to the vehicle load to prevent dazzling: turn thumb wheel  to required position.

- 0 : front seats occupied
- 1 : all seats occupied

- 2 : all seats occupied and load compartment laden
- 3 : driver's seat occupied and load compartment laden

## Headlights when driving abroad

The asymmetrical headlight beam extends visibility at the edge of the road at the passenger side.

However, when driving in countries where traffic drives on the opposite side of the road, adjust the headlights to prevent dazzling of oncoming traffic.

## Vehicles with halogen headlight system



The adjusting screws are located above the headlight.

Turn the adjusting screws with the screwdriver clockwise by half a turn.

For deactivation, turn the adjusting screws anticlockwise by half a turn.

**Caution**

Have the adjustment of the headlights checked after deactivation.

We recommend consulting a workshop.

**Vehicles with adaptive forward lighting system**

1. Key in ignition switch.
2. Pull turn signal lever and hold (headlight flash).

3. Switch on ignition.
4. After approx. three seconds, an acoustic signal sounds.

The headlights are aimed automatically.

Every time the ignition is switched on, control indicator  flashes as a reminder for approx. four seconds.

For deactivation, operate the same procedure as described above.

Control indicator  will not flash when function is deactivated.

Control indicator   $\rightarrow$  87.

**Daytime running lights**

Daytime running lights increase visibility of the vehicle during daylight.

They are switched on automatically when ignition is on.

**Adaptive forward lighting**

The Adaptive forward lighting functions are only available with Bi-Xenon headlights. Light range, light distribution and intensity of light are variably triggered depending on the light conditions, weather and road type.

**Playstreet lighting**

Activated automatically at low speed up to approx. 20 mph. The light beam is turned at an angle of  $-5^{\circ}/3^{\circ}$  to the roadside.

**Town lighting**

Activated automatically at a speed up to approx. 30 mph and when street lights are detected by the light sensor. The light range is reduced by an extended light distribution.

**Country lighting**

Activated automatically at a speed range between approx. 30 and 72 mph. The beam of light and the brightness is different between the left and the right side.

### Motorway lighting

Activated automatically at a speed above approx. 72 mph and minimal steering movements. It switches on after a delay or directly when the vehicle is powerfully accelerated. The light beam is longer and brighter.

### Adverse weather lighting

Activated automatically up to a speed of approx. 43 mph, when the rain sensor recognises condensation or the wiper operates continuously. The range, distribution and light intensity is regulated variably depending on visibility.

### Dynamic curve lighting



The light beam pivots based on steering wheel angle and speed, improving lighting in curves.

Control indicator   87.

### Corner lighting

On tight bends or when turning off, depending on the steering angle or the turn signal light, an additional left or right reflector is switched on which illuminates the road at an right angle to the direction of travel. It is activated up to a speed of 25 mph.

Control indicator   87.

### Reversing function

If the headlights are on and reverse gear is engaged, both corner lights are switched on. They remain illuminated for 20 seconds after disengaging reverse gear or until driving faster than 10 mph in a forward gear.

### High beam assist

This feature allows high beam as main driving light by night and when vehicle speed is faster than 25 mph.



It switches to low beam when:

- The camera in the windscreen detects the lights of oncoming or preceding vehicles.
- The vehicle speed is slower than 12 mph.
- It is foggy or snowy.
- Driving in urban areas.

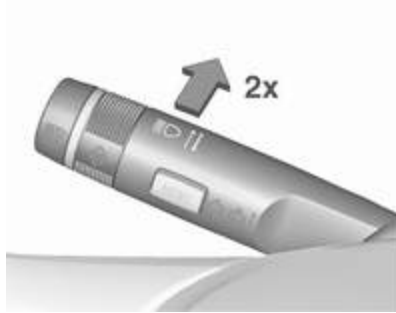

**Activation**

The high beam assist is activated by pushing the indicator lever twice at a speed above 25 mph.

The green control indicator  illuminates continuously when the assist is activated, the blue one  illuminates when high beam is on.

Control indicator   87.

**Deactivation**

Push indicator lever once. It is also deactivated when front or rear fog lights are switched on.

If a headlight flash is activated when the high beam is on, the high beam assist will be deactivated.

If a headlight flash is activated when the high beam is off, the high beam assist will remain activated.

High beam assist is always active after the ignition is switched on.

**Dynamic automatic headlight levelling**

To prevent oncoming traffic from dazzle, headlight levelling is automatically adjusted based on inclination information measured by front and rear axle, acceleration or deceleration and vehicle speed.

**Fault in Adaptive forward lighting system**

When the system detects a failure in the Adaptive forward lighting system, the system moves to a preset position to avoid dazzling of oncoming traffic. Have the cause of the failure remedied by a workshop as soon as possible.

**Hazard warning flashers**

Operated by pressing .

## Turn and lane-change signals



lever up : right turn signal  
 lever down : left turn signal

If the lever is moved past the resistance point, the turn signal is switched on constantly. When the steering wheel moves back, the turn signal is automatically deactivated.

For three flashes, e.g. when changing lanes, press the lever until resistance is felt and then release.

With a trailer connected, turn signal flashes six times and tone frequency changes when pressing the lever until resistance is felt and then releasing.

Move the lever to the resistance point and hold for longer indication.

Switch the turn signal off manually by moving the lever to its original position.

## Front fog lights



Operated by pressing #D.

## Rear fog light



Operated by pressing Q#.

Light switch in position **AUTO**: switching on rear fog light will switch headlights on automatically.

Light switch in position  $\Rightarrow \text{Q}$ : rear fog light can only be switched on with front fog lights.

## Reversing lights

The reversing light comes on when the ignition is on and reverse gear is selected.

## Misted light covers

The inside of the light housing may mist up briefly in poor, wet and cold weather conditions, in heavy rain or after washing. The mist disappears quickly by itself; to help switch on the headlights.

## Interior lighting

### Instrument panel illumination control



Brightness of the following lights can be adjusted when the exterior lights are on:

- instrument panel illumination
- steering wheel controls

Turn thumb wheel  and hold until the desired brightness is obtained.



## Interior lights

### Courtesy light

#### Front



Operate rocker switch:

- press  : off  
 : automatic switching on and off  
 press  : on

Rear



Operate rocker switch:

- | : on
- ☒ : automatic switching on and off
- : off

## Reading lights



The front reading lights are located in the overhead console.

Press and to turn each light on or off.

## Glove box lighting

Illuminates when the glovebox is opened.

## Sunvisor lights

Illuminates when the cover is opened.

## Lighting features

### Entry lighting

#### Welcome lighting

Following lights are switched on for a short time by unlocking the vehicle with the radio remote control:

- low beam
- sidelights
- tail lights
- number plate lights
- instrument panel light
- interior lights

This function works only in the dark and facilitates locating the vehicle.

Activation or deactivation of this function can be changed in the vehicle settings. Vehicle personalisation ⇨ 99.

The following lights will additionally switch on when driver's door is opened:

- illumination of some switches
- some interior lights

## Exit lighting

Low beam, sidelights and tail lights illuminate the surrounding area for an adjustable time after leaving the vehicle.

## Switching on

Activation, deactivation and duration of lighting of this function can be changed in the vehicle settings. Vehicle personalisation ⇨ 99.



1. Switch off ignition.
2. Remove ignition key.
3. Open driver's door.

4. Pull turn signal lever.
5. Close driver's door.

If the driver's door is not closed the lights switch off after a few seconds.

The lighting is switched off immediately if the turn signal lever is pulled while the driver's door is open.

## Battery discharge protection

To prevent discharge of the battery when the ignition is switched off, some interior lights are switched off automatically after some time.

## Climate control

<b>Climate control systems</b> .....	116
Heating and ventilation system	116
Air conditioning system .....	117
Electronic climate control system .....	118
Auxiliary heater .....	121
<b>Air vents</b> .....	121
Adjustable air vents .....	121
Fixed air vents .....	121
<b>Maintenance</b> .....	122
Air intake .....	122
Pollen filter .....	122
Air conditioning regular operation .....	122
Service .....	122

## Climate control systems

### Heating and ventilation system



Controls for:

- air distribution
- temperature
- fan speed
- demisting and defrosting



Heated rear window  ⇨ 31.

### Temperature

red : warm  
blue : cold

Heating will not be fully effective until the engine has reached normal operating temperature.

### Air distribution



-  : to windscreen and front door windows
-  : to head area
-  : to foot well and windscreen

Combination settings are possible.

### Fan speed

Adjust the air flow by switching the fan to the desired speed.



### Demisting and defrosting

- Press : fan automatically switches to higher speed, the air distribution is directed towards the windscreen.
- Set temperature control to warmest level.
- Switch on heated rear window .
- Open side air vents as required and direct them towards the door windows.

## Air conditioning system



In addition to the heating and ventilation system, the air conditioning system has controls for:

-  : cooling
-  : air recirculation

### Cooling

Press  to switch on cooling. The LED in the button illuminates. Cooling is only functional when the engine is running and climate control fan is switched on.

Press  again to switch off cooling.

The air conditioning system cools and dehumidifies (dries) as soon as the outside temperature is above a specific level. Therefore condensation may form and drip from under the vehicle.

If no cooling or drying is required, switch off the cooling system for fuel saving reasons. Activated cooling may inhibit Autostops.

Stop-start system  126.

### Air recirculation system

Press  to activate air recirculation mode. The LED in the button illuminates.

Press  again to deactivate air recirculation mode.

### Warning



The exchange of fresh air is reduced in air recirculation mode. In operation without cooling the air humidity increases, so the windows may mist up from inside. The quality of the passenger

compartment air deteriorates, which may cause the vehicle occupants to feel drowsy.



In warm and very humid ambient air conditions, the windscreen may mist up from outside when cold air is directed towards it. If windscreen mists up from outside, activate windscreen wiper and deactivate .

### Maximum cooling



Briefly open the windows so that hot air can disperse quickly.



- Switch on cooling .
- Air recirculation system  on.
- Press air distribution switch .
- Set temperature control to coldest level.
- Set fan speed to highest level.
- Open all vents.

## Demisting and defrosting the windows

- Press : fan automatically switches to higher speed, the air distribution is directed towards the windscreen.
- Set temperature control to warmest level.
- Switch on heated rear window .
- Open side air vents as required and direct them towards the door windows.

### Notice

If  is pressed while the engine is running, an Autostop will be inhibited until  is pressed again.

If  is pressed with the fan switched on and the engine running, an Autostop will be inhibited until  is pressed again or until the fan is switched off.

If  is pressed while the engine is in an Autostop, the engine will restart automatically.

If  is pressed with the fan switched on while the engine is in an Autostop, the engine will restart automatically.

Stop-start system ⇨ 126.

## Electronic climate control system



Controls for:

- air distribution
- temperature
- fan speed

**AUTO** : automatic mode

 : manual air recirculation

 : demisting and defrosting

Heated rear window  ⇨ 31.

The preselected temperature is automatically regulated. In automatic mode, the fan speed and air distribution automatically regulate the air flow.

The system can be manually adapted via the use of air distribution and air flow controls.



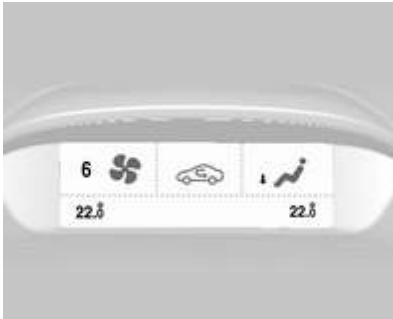

Each change of settings is shown in the Info-Display for a few seconds. The electronic climate control system is only fully operational when the engine is running.

## Automatic mode AUTO

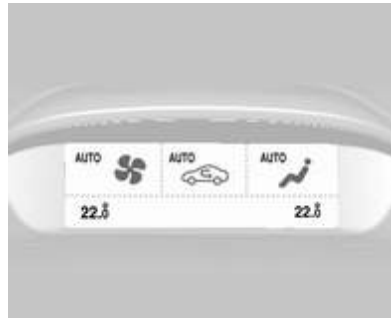

Basic setting for maximum comfort:

- Press **AUTO**: the air distribution and fan speed are regulated automatically.
- Open all air vents.
- Press  to switch on cooling.
- Set the desired temperature.

## Temperature preselection

Temperatures can be set to the desired value.

If the minimum temperature is set, the climate control system runs at maximum cooling.

If the maximum temperature is set, the climate control system runs at maximum heating.



### Notice

If the temperature is to be reduced for climate comfort reasons, an Autostop may be inhibited or the engine will restart automatically when cooling is switched on.



Stop-start system ⇨ 126.



The temperature can be adjusted separately for driver and front passenger side.

## Demisting and defrosting the windows

- Press .
- Temperature and air distribution are set automatically and the fan runs at high speed.
- Switch on heated rear window .
- To return to previous mode: press , to return to automatic mode: press **AUTO**.

**Notice**

If  is pressed while the engine is running, an Autostop will be inhibited until  is pressed again.

If  is pressed with the fan switched on and the engine running, an Autostop will be inhibited until  is pressed again or until the fan is switched off.

If  is pressed while the engine is in an Autostop, the engine will restart automatically.

If  is pressed with the fan switched on while the engine is in an Autostop, the engine will restart automatically.

Stop-start system ⇨ 126.

**Manual settings**

Climate control system settings can be changed by activating the buttons and rotary knobs as follows.

Changing a setting will deactivate the automatic mode.

**Fan speed** 

The selected fan speed is indicated with  and a number in the display. If the fan is switched off, the air conditioning is also deactivated.

To return to automatic mode: Press **AUTO**.

**Air distribution** , , 

Press appropriate button for desired adjustment. Activation is indicated by illumination of the LED in the button.

 : to windscreen and front door windows (air conditioning is activated in the background to help prevent windows from fogging)

 : to head area

 : to foot well and windscreen

Combination of settings are possible.

Return to automatic air distribution: Deactivate corresponding setting or press **AUTO**.

**Cooling** 

Press  to switch on cooling. The LED in the button illuminates. Cooling is only functional when the engine is running and climate control fan is switched on.

Press  again to switch off cooling.

The air conditioning system cools and dehumidifies (dries) when outside temperature is above a specific level. Therefore condensation may form and drip from under the vehicle.

If no cooling or drying is required, switch off the cooling system for fuel saving reasons. Activated cooling may inhibit an Autostop.

Stop-start system ⇨ 126.

**Eco** appears in the display when cooling is deactivated.

**Air recirculation mode** 

Press  once to activate the manual air recirculation mode.

**⚠ Warning**

The exchange of fresh air is reduced in air recirculation mode. In operation without cooling the air humidity increases, so the windows may mist up from inside. The quality of the passenger compartment air deteriorates, which may cause the vehicle occupants to feel drowsy.

**Air conditioning with the engine not running**

When ignition is off, the residual heat or cooling in the system can be used for climate control in passenger compartment.

**Auxiliary heater****Air heater**

Quickheat is an electric auxiliary air heater which automatically warms up the passenger compartment more quickly.

**Air vents****Adjustable air vents**

At least one air vent must be open while the cooling is on.

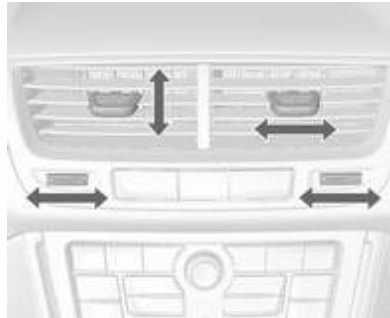

To open the vent, turn the adjuster wheel to the right. Adjust the air amount at the vent outlet by turning the adjuster wheel.

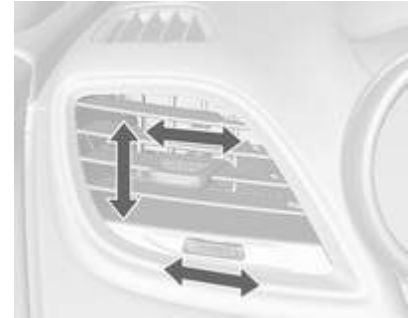

Direct the flow of air by tilting and swivelling the slats.

To close the vent, turn the adjuster wheel to the left.

**⚠ Warning**

Do not attach any objects to the slats of the air vents. Risk of damage and injury in case of an accident.

**Fixed air vents**

Additional air vents are located beneath the windscreen and door windows and in the foot wells.

## Maintenance

### Air intake

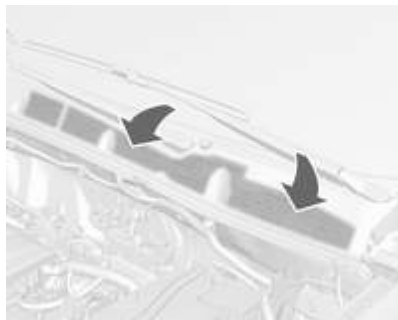

The air intake in front of the windscreen in the engine compartment must be kept clear to allow air intake.

Remove any leaves, dirt or snow.

### Pollen filter

The pollen filter cleans dust, soot, pollen and spores from the air entering the vehicle through the air intake.

## Air conditioning regular operation

In order to ensure continuously efficient performance, cooling must be operated for a few minutes once a month, irrespective of the weather and time of year. Operation with cooling is not possible when the outside temperature is too low.

## Service

For optimal cooling performance, it is recommended to annually check the climate control system, starting three years after initial vehicle registration, including:

- functionality and pressure test
- heating functionality
- leakage check
- check of drive belts
- cleaning of condenser and evaporator drainage
- performance check

# Driving and operating

<b>Driving hints</b> .....	<b>124</b>		
Control of the vehicle .....	124		
Steering .....	124		
<b>Starting and operating</b> .....	<b>124</b>		
New vehicle running-in .....	124		
Ignition switch positions .....	125		
Starting the engine .....	125		
Overrun cut-off .....	126		
Stop-start system .....	126		
Parking .....	128		
<b>Engine exhaust</b> .....	<b>129</b>		
Diesel particle filter .....	129		
Catalytic converter .....	130		
<b>Automatic transmission</b> .....	<b>130</b>		
Transmission display .....	130		
Selector lever .....	131		
Manual mode .....	132		
Electronic driving programmes	132		
Fault .....	132		
Interruption of power supply ....	132		
<b>Manual transmission</b> .....	<b>133</b>		
<b>Drive systems</b> .....	<b>134</b>		
All-wheel drive .....	134		
		<b>Brakes</b> .....	<b>135</b>
		Antilock brake system .....	135
		Parking brake .....	135
		Brake assist .....	136
		Hill start assist .....	136
		<b>Ride control systems</b> .....	<b>136</b>
		Traction Control system .....	136
		Electronic Stability Control .....	137
		Descent control system .....	138
		<b>Driver assistance systems</b> .....	<b>139</b>
		Cruise control .....	139
		Speed limiter .....	140
		Forward collision alert .....	141
		Parking assist .....	143
		Rear view camera .....	145
		Traffic sign assistant .....	147
		Lane departure warning .....	150
		<b>Fuel</b> .....	<b>151</b>
		Fuel for petrol engines .....	151
		Fuel for diesel engines .....	151
		Fuel for liquid gas operation ....	152
		Refuelling .....	154
		Fuel consumption - CO <sub>2</sub> -	
		Emissions .....	157
		<b>Trailer hitch</b> .....	<b>158</b>
		General information .....	158
		Driving characteristics and	
		towing tips .....	158
		Trailer towing .....	158
		Towing equipment .....	159

## Driving hints

### Control of the vehicle

#### Never coast with engine not running (except during Autostop)

Many systems will not function in this situation (e.g. brake servo unit, power steering). Driving in this manner is a danger to yourself and others. All systems function during an Autostop, but there will be a controlled reduction in power steering assist and vehicle speed is reduced.

Stop-start system ⇨ 126.

### Pedals

To ensure the pedal travel is uninhibited, there must be no mats in the area of the pedals.

Use only floor mats, which fit properly and are fixed by the retainers on the driver side.

## Steering

If power steering assist is lost because the engine stops or due to a system malfunction, the vehicle can be steered but may require increased effort.

Control indicator ⚠ ⇨ 85.

### Caution

Vehicles equipped with hydraulic power steering:

If the steering wheel is turned until it reaches the end of its travel, and is held in that position for more than 10 seconds, damage may occur to the power steering system and there may be loss of power steering assist.

## Starting and operating

### New vehicle running-in

Do not brake unnecessarily hard for the first few journeys.

During the first drive, smoke may occur because of wax and oil evaporating off the exhaust system. Park the vehicle in the open for a while after the first drive and avoid inhaling the fumes.

During the running-in period fuel and engine oil consumption may be higher and the cleaning process of the diesel particle filter may take place more often. Autostop may be inhibited to allow for charging the battery.

Diesel particle filter ⇨ 129.

## Ignition switch positions

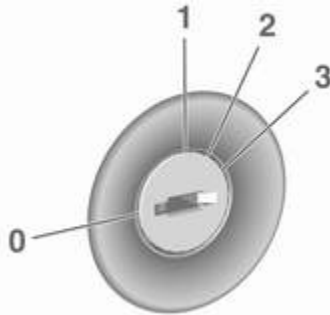

- 0 : ignition off
- 1 : steering wheel lock released, ignition off
- 2 : ignition on, for diesel engine: preheating
- 3 : starting

## Starting the engine

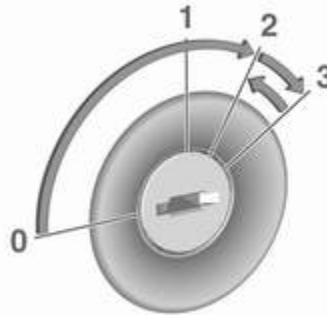

Manual transmission: operate clutch.

Automatic transmission: operate brake and move the selector lever to **P** or **N**.

Do not operate the accelerator pedal.

Diesel engine: turn the key to position **2** for preheating until control indicator  extinguishes.

Turn the key briefly to position **3** and release: an automatic procedure operates the starter with a short delay as long as the engine is running, see 'Automatic Starter Control'.

Before restarting or to switch off the engine, turn the key back to position **0**.

During an Autostop, the engine can be started by depressing the clutch pedal.

### Key lock release

Some vehicles with an automatic transmission are equipped with an electronic key lock release system. The key lock release is designed to prevent ignition key removal unless the selector lever is in **P**.

### Starting the vehicle at low temperatures

Starting the engine without additional heaters is possible down to -25 °C for diesel engines and -30 °C for petrol engines. Required is an engine oil with the correct viscosity, the correct fuel, performed services and a sufficiently charged battery. With temperatures below -30 °C the automatic transmission requires a warming phase of approx. 5 minutes. The selector lever must be in position **P**.

## Automatic Starter Control

This function controls the engine starting procedure. The driver does not need to hold the key in position **3**. Once applied, the system will go on starting automatically until the engine is running. Because of the checking procedure, the engine starts running after a short delay.

Possible reasons for a non-starting engine:

- clutch pedal not operated (manual transmission)
- brake pedal not operated or selector lever not in **P** or **N** (automatic transmission)
- timeout occurred

## Turbo engine warm-up

Upon start-up, engine available torque may be limited for a short time, especially when the engine temperature is cold. The limitation is to allow the lubrication system to fully protect the engine.

## Overrun cut-off

The fuel supply is automatically cut off during overrun, i.e. when the vehicle is driven with a gear engaged but accelerator is released.

## Stop-start system

The stop-start system helps to save fuel and to reduce the exhaust emissions. When conditions allow, it switches off the engine as soon as the vehicle is at a low speed or at a standstill, e.g. at a traffic light or in a traffic jam. It starts the engine automatically as soon as the clutch is depressed. A battery sensor ensures that an Autostop is only performed if the battery is sufficiently charged for a restart.

## Activation

The stop-start system is available as soon as the engine is started, the vehicle starts-off and the conditions as stated below in this section are fulfilled.

## Deactivation



Deactivate the stop-start system manually by pressing **A**. Deactivation is indicated when the LED in the button extinguishes.

## Autostop

If the vehicle is at a low speed or at a standstill, activate an Autostop as follows:

- Depress the clutch pedal.
- Move the selector lever to neutral.
- Release the clutch pedal.



The engine will be switched off while the ignition stays on.



An Autostop is indicated by the needle at the **AUTOSTOP** position in the tachometer.

During an Autostop, the heating performance, power steering and brake performance will be maintained.

### Conditions for an Autostop

The stop-start system checks if each of the following conditions is fulfilled:

- The stop-start system is not manually deactivated.
- The bonnet is fully closed.

- The driver's door is closed or the driver's seat belt is fastened.
- The vehicle battery is sufficiently charged and in good condition.
- The engine is warmed up.
- The engine coolant temperature is not too high.
- The engine exhaust temperature is not too high, e.g. after driving with high engine load.
- The ambient temperature is above  $-5^{\circ}\text{C}$ .
- The climate control system allows an Autostop.
- The brake vacuum is sufficient.
- The self-cleaning function of the diesel particle filter is not active.
- The vehicle was driven at least at walking speed since the last Autostop.

Otherwise an Autostop will be inhibited.

Certain settings of the climate control system may inhibit an Autostop. See Climate control chapter for more details ↗ 117.

Immediately after motorway driving an Autostop may be inhibited.

New vehicle running-in ↗ 124.

### Vehicle battery discharge protection

To ensure reliable engine restarts, several battery discharge protection features are implemented as part of the stop-start system.

### Power saving measures

During an Autostop, several electrical features such as auxiliary electric heater or rear window heating are disabled or switched into a power saving mode. The fan speed of the climate control system is reduced to save power.

### Restart of the engine by the driver

Depress the clutch pedal to restart the engine.

The engine start is indicated by the needle at the idle speed position in the tachometer.

If the selector lever is shifted out of neutral before depressing the clutch first, control indicator  illuminates or is shown as a message in the Driver Information Centre.

Control indicator  ⇨ 84.

### Restart of the engine by the stop-start system

The selector lever must be in neutral to enable an automatic restart.

If one of the following conditions occurs during an Autostop, the engine will be restarted automatically by the stop-start system:

- The stop-start system is manually deactivated.
- The bonnet is opened.
- The driver's seat belt is unfastened and the driver's door is opened.
- The engine temperature is too low.
- The charging level of the vehicle battery is below a defined level.
- The brake vacuum is not sufficient.

- The vehicle is driven at least at walking speed.
- The climate control system requests an engine start.
- The air conditioning is manually switched on.

If the bonnet is not fully closed, a warning message is displayed in the Driver Information Centre.

If an electrical accessory, e.g. a portable CD player, is connected to the power outlet, a brief power drop during engine restart might be noticeable.

### Parking

#### Warning

- Do not park the vehicle on an easily ignitable surface. The high temperature of the exhaust system could ignite the surface.
- Always apply the parking brake. Activate the parking brake without pressing the

release button. Apply as firmly as possible on a downhill slope or uphill slope. Depress brake pedal at the same time to reduce operating force.

- Switch off the engine.
- If the vehicle is on a level surface or uphill slope, engage first gear or set the selector lever to position **P** before removing the ignition key. On an uphill slope, turn the front wheels away from the kerb.

If the vehicle is on a downhill slope, engage reverse gear or set the selector lever to position **P** before removing the ignition key. Turn the front wheels towards the kerb.

- Close the windows and the sunroof.
- Remove the ignition key from the ignition switch. For vehicles with automatic transmission, the key can only be removed when the selector lever is in position **P**.

Turn the steering wheel until the steering wheel lock is felt to engage.

- Lock the vehicle.
- Activate the anti-theft alarm system.

### Notice

In the event of an accident with airbag deployment, the engine is turned off automatically if the vehicle comes to a standstill within a certain time.

## Engine exhaust

### ⚠ Danger

Engine exhaust gases contain poisonous carbon monoxide, which is colourless and odourless and could be fatal if inhaled.

If exhaust gases enter the interior of the vehicle, open the windows. Have the cause of the fault rectified by a workshop.

Avoid driving with an open load compartment, otherwise exhaust gases could enter the vehicle.

## Diesel particle filter

The diesel particle filter system filters harmful soot particles out of the exhaust gases. The system includes a self-cleaning function that runs automatically during driving without any notification. The filter is cleaned by periodically burning off the soot particles at high temperature. This process takes place automatically under set driving conditions and may take up to 25 minutes. Typically it

needs between 7 and 12 minutes. Autostop is not available and fuel consumption may be higher during this period. The emission of smells and smoke during this process is normal.



Under certain driving conditions, e.g. short distances, the system cannot clean itself automatically.

If cleaning of the filter is required and if previous driving conditions did not enable automatic cleaning, it will be indicated by control indicator .

 illuminates when diesel particle filter is full. Start cleaning process as soon as possible.

↻ flashes when diesel particle filter has reached the maximum filling level. Start cleaning process immediately to avoid damage to the engine.

### Cleaning process

To activate cleaning process, continue driving, keep engine speed above 2000 revolutions per minute. Shift down if necessary. Diesel particle filter cleaning is then started. If control indicator ↻ also illuminates, cleaning is not possible: seek the assistance of a workshop.

#### Caution

If the cleaning process is interrupted, there is a risk of provoking severe engine damage.

Cleaning takes place quickest at high engine speeds and loads.

The control indicator ↻ extinguishes as soon as the self-cleaning operation is complete.

### Catalytic converter

The catalytic converter reduces the amount of harmful substances in the exhaust gases.

#### Caution

Fuel grades other than those listed on pages ↻ 151, ↻ 212 could damage the catalytic converter or electronic components.

Unburnt petrol will overheat and damage the catalytic converter. Therefore avoid excessive use of the starter, running the fuel tank dry and starting the engine by pushing or towing.

In the event of misfiring, uneven engine running, a reduction in engine performance or other unusual problems, have the cause of the fault rectified by a workshop as soon as possible. In an emergency, driving can be continued for a short period, keeping vehicle speed and engine speed low.

### Automatic transmission

The automatic transmission permits automatic gearshifting (automatic mode) or manual gearshifting (manual mode).

### Transmission display

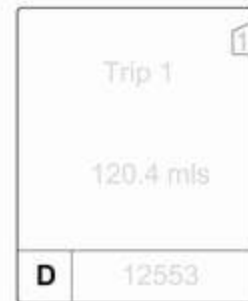

The mode or selected gear is shown in the transmission display.

## Selector lever



- P** : park position, wheels are locked, engage only when the vehicle is stationary and the parking brake is applied
- R** : reverse gear, engage only when the vehicle is stationary
- N** : neutral
- D** : automatic mode
- M** : manual mode
- +** : upshift in manual mode
- : downshift in manual mode

The selector lever is locked in **P** and can only be moved when the ignition is on and the brake pedal is applied.



To engage **P** or **R**, press the release button.

The engine can only be started with the lever in position **P** or **N**. When position **N** is selected, press the brake pedal or apply the parking brake before starting.

Do not accelerate while engaging a gear. Never depress the accelerator pedal and brake pedal at the same time.

When a gear is engaged, the vehicle slowly begins to creep when the brake is released.

## Engine braking

To utilise the engine braking effect, select a lower gear in good time when driving downhill, see manual mode.

## Rocking the vehicle

Rocking the vehicle is only permissible if the vehicle is stuck in sand, mud or snow. Move the selector lever between **D** and **R** in a repeat pattern. Do not race the engine and avoid sudden acceleration.

## Parking

Apply the parking brake and engage **P**.

The ignition key can only be removed when the selector lever is in position **P**.

## Manual mode



Move selector lever to position **M**.  
Press button on the selector lever:

**+** : shift to a higher gear

**-** : shift to a lower gear

If a higher gear is selected when vehicle speed is too low, or a lower gear when vehicle speed is too high, the shift is not executed. This can cause a message in the Driver Information Centre.

In manual mode no automatic shifting to a higher gear takes place at high engine revolutions.

## Electronic driving programmes

- Following a cold start, the operating temperature programme increases engine speed to quickly bring the catalytic converter to the required temperature.
- The automatic neutral shift function automatically shifts to idling when the vehicle is stopped with a forward gear engaged and the brake pedal is pressed.
- Special programmes automatically adapt the shifting points when driving up inclines or down hills.

## Kickdown

If the accelerator pedal is pressed down completely in automatic mode, the transmission shifts to a lower gear depending on engine speed.

## Fault

In the event of a fault,  illuminates. Additionally a code number or a vehicle message is displayed in the Driver Information Centre. Vehicle messages ⇨ 93.

The transmission no longer shifts automatically. Continued travel is possible with manual shifting.

Only the highest gear is available. Depending on the fault, second gear may also be available in manual mode. Shift only when vehicle is at a standstill.

Have the cause of the fault remedied by a workshop.

## Interruption of power supply

In the event of an interruption of power supply, the selector lever cannot be moved out of the **P** position. The ignition key cannot be removed from the ignition switch.

If the battery is discharged, start the vehicle using jump leads ⇨ 197.

If the battery is not the cause of the fault, release the selector lever.

1. Keep the brake pedal depressed and pull the parking brake lever up.



2. Remove the cap on the console with a thin object such as a screwdriver.



3. Insert a screwdriver into the opening as far as it will go.
4. Shift selector lever to **N**.
5. Remove the screwdriver from the slot.
6. Reinstall the cap.
7. Have the cause of the power supply interruption remedied by a workshop.

## Manual transmission

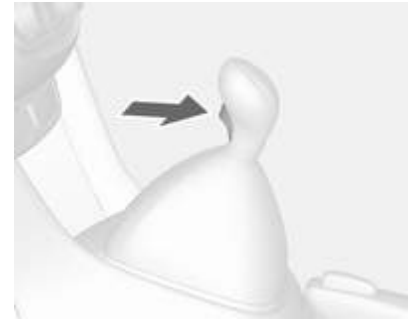

To engage reverse, with the vehicle stationary, depress clutch pedal, press the release button on the selector lever and engage the gear.

If the gear does not engage, set the lever to neutral, release the clutch pedal and depress again; then repeat gear selection.

Do not slip the clutch unnecessarily.

When operating, depress the clutch pedal completely. Do not use the pedal as a foot rest.

**Caution**

It is not advisable to drive with the hand resting on the selector lever.

Stop-start system ⇨ 126.

## Drive systems

### All-wheel drive

The All-Wheel Drive (AWD) system enhances driving characteristics and stability, and helps to achieve the best possible driveability regardless of ground surface. The system is always active and cannot be deactivated.

The torque is distributed steplessly between the wheels of the front and rear axle, depending on the driving conditions. Additionally the torque between the rear wheels is distributed depending on the surface.

For optimum system performance, the vehicle's tyres should not have varying degrees of wear.

When using a temporary spare wheel, the AWD system is automatically disabled.

The AWD system will also be temporarily disabled to protect the system from overheating if there is excessive wheel spin. When the system cools down, AWD will be restored.

The deactivation of the AWD system will be indicated by a message on the Driver Information Centre.

If a service message or warning code S73 is displayed on the Driver Information Centre, there is a malfunction in the AWD system. Seek the assistance of a workshop.

Vehicle messages ⇨ 93, Towing the vehicle ⇨ 199.



## Brakes

The brake system comprises two independent brake circuits.

If a brake circuit fails, the vehicle can still be braked using the other brake circuit. However, braking effect is achieved only when the brake pedal is depressed firmly. Considerably more force is needed for this. The braking distance is extended. Seek the assistance of a workshop before continuing the journey.

When the engine is not running, the support of the brake servo unit disappears once the brake pedal has been depressed once or twice. Braking effect is not reduced, but braking requires significantly greater force. It is especially important to bear this in mind when being towed.

Control indicator (ⓘ) ⇨ 84.

## Antilock brake system

Antilock brake system (ABS) prevents the wheels from locking.

ABS starts to regulate brake pressure as soon as a wheel shows a tendency to lock. The vehicle remains steerable, even during hard braking.

ABS control is made apparent through a pulse in the brake pedal and the noise of the regulation process.

For optimum braking, keep the brake pedal fully depressed throughout the braking process, despite the fact that the pedal is pulsating. Do not reduce the pressure on the pedal.

After starting-off the system performs a self-test which may be audible.

Control indicator (Ⓜ) ⇨ 84.

## Adaptive brake light

During full braking, all three brake lights flash for the duration of ABS control.

## Fault

### ⚠ Warning

If there is a fault in the ABS, the wheels may be liable to lock due to braking that is heavier than normal. The advantages of ABS are no longer available. During hard braking, the vehicle can no longer be steered and may swerve.

Have the cause of the fault remedied by a workshop.

## Parking brake



**⚠ Warning**

Always apply parking brake firmly without operating the release button, and apply as firmly as possible on a downhill or uphill slope.

To release the parking brake, pull the lever up slightly, press the release button and fully lower the lever.

To reduce the operating forces of the parking brake, depress the brake pedal at the same time.

Control indicator (D) ⇨ 84.

**Brake assist**

If the brake pedal is depressed quickly and forcefully, maximum brake force is automatically applied (full braking).

Maintain steady pressure on the brake pedal for as long as full braking is required. Maximum brake force is automatically reduced when the brake pedal is released.

**Hill start assist**

The system helps prevent unintended movement when driving away on inclines.

When releasing the brake pedal after stopping on an incline, the brakes remain on for a further two seconds. The brakes release automatically as soon as the vehicle begins to accelerate.

The hill start assist is not active during an Autostop.

Stop-start system ⇨ 126.

**Ride control systems****Traction Control system**

The Traction Control system (TC) is a component of the Electronic Stability Control (ESC) ⇨ 137.

TC improves driving stability when necessary, regardless of the type of road surface or tyre grip, by preventing the drive wheels from spinning.

As soon as the drive wheels starts to spin, engine output is reduced and the wheel spinning the most is braked individually. This considerably improves the driving stability of the vehicle on slippery road surfaces.

TC is operational after each engine start as soon as the control indicator  extinguishes.

When TC operates  flashes.

**⚠ Warning**



Do not let this special safety feature tempt you into taking risks when driving.

Adapt speed to the road conditions.

Control indicator   86.

**Deactivation**

TC can be switched off when spinning of drive wheels is required:

press  briefly to deactivate TC,  illuminates. Deactivation is displayed as status message in the Driver Information Centre.

TC is reactivated by pressing  again.

TC is also reactivated the next time the ignition is switched on.

**Electronic Stability Control**

Electronic Stability Control (ESC) improves driving stability when necessary, regardless of the type of road surface or tyre grip.

As soon as the vehicle starts to swerve (understeer/oversteer), engine output is reduced and the wheels are braked individually.

ESC operates in combination with the Traction Control system (TC). It prevents the drive wheels from spinning.



ESC is operational after each engine start as soon as the control indicator  extinguishes.

When ESC operates  flashes.

**⚠ Warning**

Do not let this special safety feature tempt you into taking risks when driving.

Adapt speed to the road conditions.

Control indicator   86.

**Deactivation**

ESC can be deactivated: press and hold  for approx. five seconds.

Control indicators  and  illuminate.

ESC is reactivated by pressing  again. If the TC system was previously disabled, both TC and ESC are reactivated.

ESC is also reactivated the next time the ignition is switched on.

### Fault

If there is a fault in the system the control indicator  illuminates continuously and a message appears in the Driver Information Centre. The system is not operational.

Have the cause of the fault remedied by a workshop.

### Descent control system

The Descent control system (DCS) allows the vehicle to travel at a low speed without depressing the brake pedaal. The vehicle will automatically decelerate to a low speed and remain at that speed when the system is



activated. Some noise or vibration from the brake system may be apparent when the system is active.

#### Caution

Use only when descending steep grades while driving off-road. Do not use when driving on normal road surfaces. Unnecessary usage of the DCS function, such as while driving on normal roads, may damage the brake system and the ESC function.

#### Switching on



At speeds below approx. 25 mph, press . DCS is operational as soon as control indicator  illuminates.

#### Activation



DCS is active at speeds between 1.2 and 22 mph. Depending on the current speed, the vehicle will be accelerated or decelerated to a speed between 3 and 12 mph. When DCS is active,  flashes.

DCS will only be activated on roads with a certain incline.

#### Deactivation

DCS is deactivated if the vehicle is decelerated below 1.2 mph or accelerated above 22 mph.

#### Switching off

Press  again. Control indicator  extinguishes.

At speeds above 37 mph the system is deactivated automatically.

## Driver assistance systems

### ⚠ Warning

Driver assistance systems are developed to support the driver and not to replace the driver's attention.

The driver accepts full responsibility when driving the vehicle.

When using driver assistance systems, always take care regarding the current traffic situation.

## Cruise control

The Cruise control can store and maintain speeds of approx. 20 to 120 mph. Deviations from the stored speeds may occur when driving uphill or downhill.

For safety reasons, the cruise control cannot be activated until the brake pedal has been operated once. Activating in first gear is not possible.





Do not use the cruise control if it is not advisable to maintain a constant speed.

With automatic transmission, only activate cruise control in automatic mode.

Control indicator   88.

### Switching on

Press : control indicator  in instrument cluster illuminates white.

### Activation

Accelerate to the desired speed and turn thumb wheel to **SET/-**: the current speed is stored and

maintained. Control indicator  in instrument cluster illuminates green. Accelerator pedal can be released.

Vehicle speed can be increased by depressing the accelerator pedal. When the accelerator pedal is released, the previously stored speed is resumed.

Cruise control remains activated while gearshifting.

### Increase speed



With cruise control active, hold thumb wheel turned to **RES/+** or briefly turn to **RES/+** repeatedly: speed increases continuously or in small increments.

Alternatively accelerate to the desired speed and store by turning to **SET/-**.

### Reduce speed

With cruise control active, hold thumb wheel turned to **SET/-** or briefly turn to **SET/-** repeatedly: speed decreases continuously or in small increments.

## Deactivation

Press : control indicator  in instrument cluster illuminates white. Cruise control is deactivated. Last stored speed remains in memory for later speed resume.



Automatic deactivation:

- Vehicle speed is below approx. 20 mph.
- Vehicle speed is above approx. 125 mph.
- The brake pedal is depressed.
- The clutch pedal is depressed for a few seconds.
- Selector lever is in **N**.
- Engine speed is in a very low range.
- The Traction Control system (TC) or Electronic Stability Control (ESC) is operating.

## Resume stored speed

Turn thumb wheel to **RES/+** at a speed above 20 mph. The stored speed will be resumed.

## Switching off

Press : control indicator  in instrument cluster extinguishes. The stored speed is deleted.

Pressing  for activating speed limiter or switching off the ignition also switches off cruise control and deletes the stored speed.

## Speed limiter

The speed limiter prevents the vehicle exceeding a preset maximum speed.



The maximum speed can be set at a speed above 15 mph.

The driver can only accelerate up to the preset speed. Deviations from the limited speed may occur when driving downhill.

The preset speed limit is displayed in the top line of the Driver Information Centre when the system is active.

## Activation



Press . If cruise control or adaptive cruise control has been activated before, it is switched off when speed limiter is activated and control indicator  extinguishes.

## Set speed limit

With speed limiter active, hold thumb wheel turned to **RES/+** or briefly turn to **RES/+** repeatedly until the desired maximum speed is displayed in the Driver Information Centre.

Alternatively accelerate to the desired speed and briefly turn thumb wheel to **SET/-**: the current speed is stored as

maximum speed. Speed limit is displayed in the Driver Information Centre.



### Change speed limit

With speed limiter active, turn thumb wheel to **RES/+** to increase or **SET/-** to decrease the desired maximum speed.

### Exceeding the speed limit

In the event of an emergency, it is possible to exceed the speed limit by depressing the accelerator pedal firmly beyond the point of resistance.

The limited speed will flash in the Driver Information Centre and a chime sounds during this period.

Release the accelerator pedal and the speed limiter function is reactivated once a speed lower than the limit speed is obtained.

### Deactivation

Press : speed limiter is deactivated and the vehicle can be driven without speed limit.

The limited speed is stored and a corresponding message appears in the Driver Information Centre.

### Resume limit speed

Turn thumb wheel to **RES/+**. The stored speed limit will be obtained.

### Switching off



Press , the speed limit indication in the Driver Information Centre extinguishes. The stored speed is deleted.

By pressing  to activate cruise control or adaptive cruise control or by switching off the ignition, speed limiter is also deactivated and the stored speed is deleted.

## Forward collision alert

The forward collision alert can help to avoid or reduce the damage caused by front-end crashes. If a vehicle directly ahead is approached too quickly, a warning chime and alert in the Driver Information Centre is provided.



The green illuminated vehicle ahead symbol  appears in the speedometer when the system has detected a vehicle in the driving path. A precondition is that forward collision alert is activated in the vehicle personalisation menu  99 or that it is not deactivated by pressing  (depending on the system, see following).

### Forward collision alert based on front camera system

Forward collision alert uses the front camera system in the windscreen to detect a vehicle directly ahead, in your path, within a distance of approx. 60 metres.



#### Activation

Forward collision alert operates automatically above 25 mph, if it is not deactivated by pressing , see below.

#### Selecting the alert sensitivity

The alert sensitivity can be set to near, medium or far.



Press : the current setting is shown on the Driver Information Centre. Press  again to change the alert sensitivity.

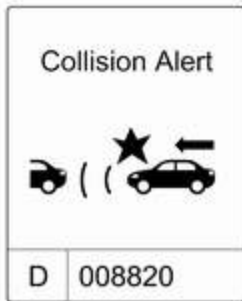

### Alerting the driver



When approaching another vehicle too rapidly, the collision alert warning page will be indicated in the Driver Information Centre. Simultaneously a warning chime sounds. Depress the brake pedal, if it is required by the situation.

#### Deactivation

The system can be deactivated. Press  repeatedly until the following message appears in the Driver Information Centre.





## General information

### ⚠ Warning

Forward collision alert is just a warning system and does not apply the brakes. When approaching a vehicle ahead too rapidly, it may not provide you enough time to avoid a collision.

The driver accepts full responsibility for the appropriate following distance based on traffic, weather and visibility conditions.

The complete attention of the driver is always required while driving. The driver must always be ready to take action and apply the brakes.

### System limitations

The system is designed to warn only for vehicles, but may react also to other metallic objects.

In the following cases, forward collision alert may not detect a vehicle ahead or sensor performance is limited:

- on winding roads
- when weather limits visibility, e.g. fog, rain, or snow
- when the sensor is blocked by snow, ice, slush, mud, dirt, or windscreen damage

## Parking assist

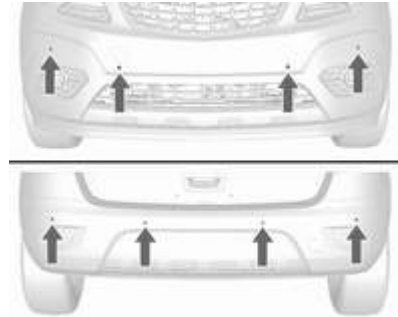

The parking assist makes parking easier by measuring the distance between the vehicle and obstacles, and giving acoustic signals. It is the driver, however, who bears full responsibility for the parking manoeuvre.

The system consists of four ultrasonic parking sensors in the rear bumper. If the vehicle is equipped with a front parking assist the system consists of four additional ultrasonic parking sensors in the front bumper.

Control indicator **P** ⚠ ↻ 85.

**Activation**

When reverse gear is engaged, the system is activated automatically.

The front parking assist can also be activated at a low speed by pressing **P** with a triangle symbol.

An illuminated LED in the parking assist button indicates that the system is ready to operate.

An obstacle is indicated by a buzzing sound. The interval between the sounds becomes shorter as the vehicle gets closer to the obstacle. When the distance is less than 30 cm, the buzzing is continuous.

If **P** with a triangle symbol is pressed once within an ignition cycle, the front parking assist is reactivated if the vehicle speed goes below a certain value and if the vehicle speed has not exceeded 16 mph beforehand.

**Deactivation**

Deactivate the system by pressing **P** with a triangle symbol.

The LED in the button will go out and **Park Assist Off** will be displayed in the Driver Information Centre.

The system is deactivated automatically at a certain speed.

**Fault**

In the event of a fault in the system, **P** with a triangle symbol illuminates or a vehicle message is displayed in the Driver Information Centre.

Additionally, **P** with a triangle symbol illuminates or a vehicle message is displayed in the Driver Information Centre if a malfunction of the system due to temporary conditions, e.g. snow covered sensors is detected.

Vehicle messages ↻ 93.

**Important hints for using the parking assist systems****Warning**

Under certain circumstances, various reflective surfaces on objects or clothing as well as external noise sources may cause the system to fail to detect obstacles.

Special attention has to be paid to low obstacles which can damage the lower part of the bumper. If such obstacles leave the detection area of the sensors during approach of the vehicle, a continuous warning tone will sound.

**Caution**

Performance of the system can be reduced when sensors are covered, e.g. by ice or snow.

Performance of the parking assist system can be reduced due to heavy loading.

Special conditions apply if there are taller vehicles in the vicinity (e.g. off-road vehicles, mini vans, vans). Object identification and correct distance indication in the upper part of these vehicles cannot be guaranteed.

Objects with a very small reflection cross-section, e.g. objects of narrow size or soft materials, may not be detected by the system.

Parking assist systems do not detect objects outside the detection range.

#### Notice

The parking assist system automatically detects factory-fitted towing equipment. It is deactivated when the connector is plugged in.

The sensor may detect a non-existent object (echo disturbance) caused by external acoustic or mechanical disturbances.

#### Notice

The parking assist is deactivated when the rear carrier system is extended.

## Rear view camera

The rear view camera assists the driver when reversing by displaying a view of the area behind the vehicle.

The view of the camera is displayed in the Colour-Info-Display.

### ⚠ Warning

The rear view camera does not replace driver vision. Note that objects that are outside the camera's field of view and the advanced parking assist sensors, e.g. below the bumper or underneath the vehicle, are not displayed.

Do not reverse the vehicle by only looking at the Info-Display and check the surrounding area behind and around the vehicle before reversing.

### Activation

Rear view camera is automatically activated when reverse gear is engaged.

## Functionality



The camera is mounted in the tailgate handle and has a viewing angle of 130°.

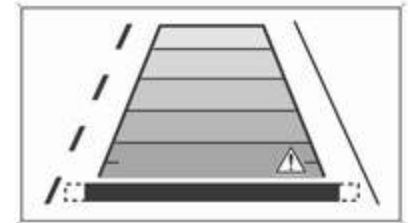

Due to the high position of the camera the rear bumper can be seen on the display as a guide to position.

The area displayed by the camera is limited. The distance of the image that appears on the display differs from the actual distance.

### Guiding lines

Dynamic guiding lines are horizontal lines in 1 metre intervals projected on the picture to define the distance to shown objects.

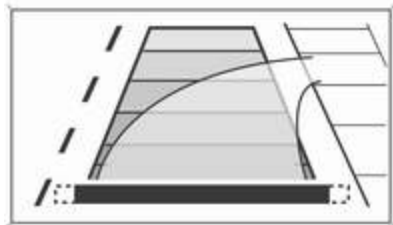

Trajectory lane of the vehicle is shown in accordance with the steering angle.

The function can be deactivated in the menu **Settings** in the Info-Display. Vehicle personalisation ⇨ 99.

### Warning symbols

Warning symbols are indicated as triangles  $\triangle$  on the picture which show obstacles detected by the rear sensors of the advanced parking assist.

### Display settings

**Navi 650/Navi 950:** Brightness can be set by first pressing and then turning the outer ring of the multifunction knob.

**CD 600:** Brightness can be set by first pressing and then turning the multifunction knob.

### Deactivation

The camera is deactivated when a certain forward speed is exceeded or if reverse gear is not engaged for approx. 10 seconds.

Activation or deactivation of the rear view camera can be changed in the menu **Settings** in the Info-Display. Vehicle personalisation ⇨ 99.

### Fault

Fault messages are displayed with a  $\triangle$  on the top line of the Info-Display.

The rear view camera may not operate properly when:

- The surrounding area is dark.
- The sun or the beam of headlights is shining directly into the camera lens.
- Ice, snow, mud, or anything else covers the camera lens. Clean the lens, rinse it with water, and wipe it with a soft cloth.
- The tailgate is not closed correctly.
- The vehicle had a rear-end accident.
- There are extreme temperature changes.

## Traffic sign assistant

### Functionality

The traffic sign assistant system detects designated traffic signs via a front camera and displays them in the Driver Information Centre.



Traffic signs which will be detected are:

### Limit and no passing signs

- speed limit
- no passing
- end of speed limit
- end of no passing

### Road signs

Beginning and end of:

- motorways
- A-roads
- play streets

### Add-on signs

- additional hints to traffic signs
- restriction of trailer towing
- wet warning
- ice warning
- direction arrows

Speed limit signs are displayed in the Driver Information Centre until the next speed limit sign or end of speed limit is detected or up to a defined sign timeout.



Combinations of more signs in the display are possible.



An exclamation mark in a frame indicates that there is an add-on sign detected which cannot be recognised by the system.

The system is active up to a speed of 124 mph depending on the lighting conditions. At night the system is active up to a speed of 99 mph.

As soon as the speed becomes slower than 34 mph the display will be reset and the content of the traffic sign page will be cleared. The next recognised speed indication will be displayed.

### Display indication



Traffic signs are displayed on the page **Traffic sign detection** in the Driver Information Centre, chosen via the adjuster wheel on the turn signal lever ↻ 88.

When another function in the Driver Information Centre was selected and then **Traffic sign detection** page is chosen again, the last recognised traffic sign will be displayed.

After the traffic sign page is cleared by the system, the following symbol is indicated:



The content of the traffic sign page is also cleared during driving by pressing **SET/CLR** on the turn signal lever for a longer time.



### Pop-up function

Speed limits and no passing signs are displayed as pop-ups on each page of the Driver Information Centre.



The pop-up function can be deactivated on the traffic sign page by pressing **SET/CLR** on the turn signal lever.

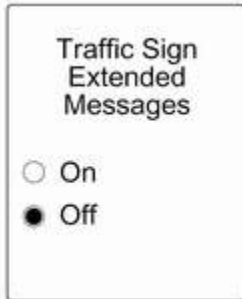

Once setting page is displayed, select **Off** to deactivate pop-up function. Reactivated by selecting **On**. When switching on the ignition, pop-up function is deactivated.

Pop-up indication is displayed for approx. eight seconds in the Driver Information Centre.

### Fault

The traffic sign assistant system may not operate correctly when:

- The area of the windscreen, where the front camera is located, is not clean.
- Traffic signs are completely or partially covered or difficult to discern.
- There are adverse environmental conditions, e.g. heavy rain, snow, direct sunlight or shadows. In this case **No Traffic Sign Detection due to Weather** is indicated on the display.

- Traffic signs are incorrectly mounted or damaged.
- Traffic signs do not comply with the Vienna Convention on traffic signs (Wiener Übereinkommen über Straßenverkehrszeichen).

### Caution

The system is intended to help the driver within a defined speed range to recognise certain traffic signs. Do not ignore traffic signs which are not displayed by the system.

The system does not recognise any other than the conventional traffic signs that might give or end a speed limit.

Do not let this special feature tempt you into taking risks when driving.

Always adapt speed to the road conditions.

The driver assistance systems do not relieve the driver from full responsibility for vehicle operation.

## Lane departure warning

The lane departure warning system observes the lane markings between which the vehicle is driving via a front camera. The system detects lane changes and warns the driver in the event of an unintended lane change via visual and acoustic signals.

Criteria for the detection of an unintended lane change are:

- no operation of turn signals
- no brake pedal operation
- no active accelerator operation or speeding-up
- no active steering

If the driver is active, no warning will be issued.

## Activation



The lane departure warning system is activated by pressing . The illuminated LED in the button indicates that the system is switched on. When the control indicator in the instrument cluster illuminates green, the system is ready to operate.

The system is only operable at vehicle speeds above 35 mph and if lane markings are available.

When the system recognises an unintended lane change, the control indicator changes to yellow and flashes. Simultaneously a chime sound is activated.



## Deactivation

The system is deactivated by pressing , the LED in the button extinguishes.

At speeds below 35 mph the system is inoperable.

## Fault

The lane departure warning system may not operate properly when:

- the windscreen is not clean
- there are adverse environmental conditions like heavy rain, snow, direct sunlight or shadows



The system can not operate when no lane marking is detected.

## Fuel

### Fuel for petrol engines

Only use unleaded fuel that complies with European standard EN 228 or E DIN 51626-1 or equivalent.

The engine is capable of running with fuel that contains up to 10% ethanol (e.g. named E10).

Use fuel with the recommended octane rating. The engine specific requirements are given in the engine data overview ↗ 212. A country specific label at the fuel filler flap can supersede the requirement.

#### Caution

Do not use fuel or fuel additives that contain metallic compounds such as manganese-based additives. This may cause engine damage.

#### Caution

Use of fuel that does not comply to EN 228 or E DIN 51626-1 or equivalent can lead to deposits or engine damage.

#### Caution

Use of fuel with too low an octane rating could lead to uncontrolled combustion and engine damage.

### Fuel for diesel engines

Only use diesel fuel that complies with EN 590.

In countries outside the European Union use Euro-Diesel fuel with a sulphur concentration below 50 ppm.

#### Caution

Use of fuel that does not comply to EN 590 or similar can lead to engine powerloss, increased wear or engine damage.

Do not use marine diesel oils, heating oils, Aquazole and similar diesel-water emulsions. Diesel fuels must not be diluted with fuels for petrol engines.

## Fuel for liquid gas operation

Liquid gas is known as LPG (Liquefied Petroleum Gas) or under its French name GPL (Gaz de Pétrole Liquéfié). LPG is also known as Autogas.

LPG consists mainly of propane and butane. The octane rating is between 105 and 115, depending on the butane proportion. LPG is stored as a liquid at a pressure of approx. five to ten bar.

The boiling point depends on the pressure and the mixing ratio. At ambient pressure, it is between -42 °C (pure propane) and -0.5 °C (pure butane).

### Caution

The system works at an ambient temperature of approx. -8 °C to 100 °C.

Full functioning of the LPG system can only be guaranteed with liquid gas which complies with the minimum requirements of DIN EN 589.

### Fuel selector



Pressing **LPG** switches between petrol and liquid gas operation as soon as the required parameters (coolant temperature, gas temperature and minimum engine

speed) have been reached. The requirements are usually fulfilled after approx. 60 seconds (depending on exterior temperature) and the first firm press on the accelerator. The status LED shows the current operating mode.

- LED off : petrol operation
- LED flashes : checking conditions for fuel transition to liquid gas operation. Illuminates if conditions are fulfilled.
- LED illuminates : liquid gas operation
- LED flashes five times and extinguishes : liquid gas tank is empty or failure in liquid gas system. A message is displayed in the Driver Information Centre.

If the fuel tank is empty, the engine will not start.

The selected fuel mode is stored and reactivated at the next ignition cycle if conditions allow.

As soon as the liquid gas tanks are empty, petrol operation is automatically engaged until the ignition is switched off.

When switching automatically between petrol or gas operation, a brief delay of engine tractive power may be noticeable.

Every six months, run the petrol tank down until control indicator ● illuminates, then refuel. This helps maintain fuel quality and system function for petrol operation.

Fill the tank completely at regular intervals to prevent corrosion in the tank.

#### **Faults and remedies**

If gas mode is not possible, check the following:

- Is there enough liquid gas present?
- Is there enough petrol present for starting?

Due to extreme temperatures in combination with the gas composition, it may take slightly longer before the system switches from petrol to gas mode.

In extreme situations, the system may also switch back to petrol mode if the minimum requirements are not fulfilled. If conditions allow, it may be possible to manually switch back to liquid gas operation.

Seek the assistance of a workshop in the event of all other faults.

#### **Caution**

Repairs and adjustments may only be made by trained specialists in order to maintain the safety and warranty on the LPG system.

Liquid gas is given a particular odour (odorised) so that any leaks can be detected easily.

#### **⚠ Warning**

If you smell gas in the vehicle or in the immediate vicinity, switch to petrol mode immediately. No smoking. No naked flames or ignition sources.

If the gas odour persists, do not start the engine. Have the cause of the fault remedied by a workshop.

When using underground car parks, follow the instructions of the operator and local laws.

#### **Notice**

In the event of an accident, switch off the ignition and lights.

## Refuelling



### **⚠ Danger**

Before refuelling, switch off ignition and any external heaters with combustion chambers.

Follow the operating and safety instructions of the filling station when refuelling.

### **⚠ Danger**

Fuel is flammable and explosive. No smoking. No naked flames or sparks.

If you can smell fuel in your vehicle, have the cause of this remedied immediately by a workshop.

### **Caution**

In case of misfuelling, do not switch on ignition.

Fuel filler flap is located at right rear side of vehicle.



The fuel filler flap can only be opened if the vehicle is unlocked. Push flap and open.

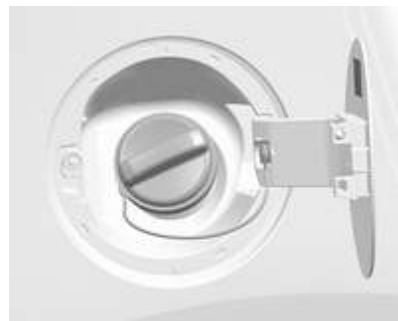

Turn the fuel filler cap slowly anticlockwise to open.

The fuel filler cap can be retained in the bracket on the fuel filler flap.

To refuel, fully insert the pump nozzle and switch it on.

After automatic cut-off, the tank can be topped up by operating the pump nozzle a maximum of two more times.

### Caution

Wipe off any overflowing fuel immediately.

To close, turn the fuel filler cap clockwise until it clicks.

Close the flap and allow it to engage.

### Liquid gas refuelling

Follow the operating and safety instructions of the filling station when refuelling.

The filling valve for the liquid gas is behind the fuel filler cap.



Unscrew protective cap from the filler neck.



Screw the required adapter hand-tight onto the filler neck.



**ACME Adapter:** Screw the nut of the filling nozzle onto the adapter. Press locking lever on filler nozzle down.

**DISH filler neck:** Place the filler nozzle into the adapter. Press locking lever on filler nozzle down.

**Bayonet filler neck:** Place filler nozzle on the adapter and turn clockwise or anticlockwise through one quarter turn. Pull locking lever of filler nozzle fully.

**EURO filler neck:** Press the filler nozzle onto the adapter until it engages.

Press the button at the liquid gas supply point. The filling system stops or begins to run slowly when 80% of the tank volume is reached (maximum fill level).

Release button on filling system and the filling process stops. Release the locking lever and remove the filler nozzle. A small quantity of liquid gas may escape.

Remove adapter and stow in vehicle.

Fit protective cap to prevent the penetration of foreign bodies into the filler opening and the system.

### **⚠ Warning**

Due to the system design, an escape of liquid gas after releasing the locking lever is unavoidable. Avoid inhaling.

### **⚠ Warning**

The liquid gas tank should only be filled to 80% capacity, for safety reasons.

The multivalve on the liquid gas tank automatically limits the fill quantity. If a larger quantity is added, we recommend not exposing the vehicle to the sun until the excess amount has been used up.

### **Filling adapter**

As filling systems are not standardised, different adapters are required which are available from Vauxhall Distributors and from Vauxhall Authorised Repairers.



**ACME adapter:** Belgium, Germany, Ireland, Luxembourg, Switzerland



**Bayonet adapter:** Netherlands, Norway, Spain, United Kingdom



**EURO adapter:** Spain



**DISH adapter:** Austria, Bosnia-Herzegovina, Bulgaria, Czech Republic, Croatia, Denmark, Estonia, France, Greece, Hungary, Italy, Latvia, Lithuania, Macedonia, Poland, Portugal, Romania, Serbia, Slovakia, Slovenia, Sweden, Switzerland, Turkey, Ukraine

### Fuel filler cap

Only use genuine fuel filler caps. Diesel-engined vehicles have special fuel filler caps.

## Fuel consumption - CO<sub>2</sub>-Emissions

The values for fuel consumption (combined) of the model Vauxhall Mokka is within a range of 36 to 69 mpg.

The values for CO<sub>2</sub> emission (combined) is within a range of 159 to 109 g/km.

For the values specific to your vehicle, refer to the EEC Certificate of Conformity provided with your vehicle or other national registration documents.

### General information

The official fuel consumption and specific CO<sub>2</sub> emission figures quoted relate to the EU base model with standard equipment.

Fuel consumption data and CO<sub>2</sub> emission data are determined according to regulation R (EC) No. 715/2007 (in the latest applicable version), taking into

consideration the vehicle weight in running order, as specified by the regulation.

The figures are provided only for the purpose of comparison between different vehicle variants and must not be taken as a guarantee for the actual fuel consumption of a particular vehicle. Additional equipment may result in slightly higher results than the stated consumption and CO<sub>2</sub> figures.

Furthermore, fuel consumption is dependent on personal driving style as well as road and traffic conditions.

## Trailer hitch

### General information

Only use towing equipment that has been approved for your vehicle. Entrust retrofitting of towing equipment to a workshop. It may be necessary to make changes that affect the cooling system, heat shields or other equipment.

The bulb outage detection function for trailer brake light cannot detect a partial bulb outage, e.g. in case of four times five watt bulbs, the function only detects lamp outage when only a single five Watt lamp remains or none remain.

Fitting of towing equipment could cover the opening of the towing eye. If this is the case, use the coupling ball bar for towing. Always keep the coupling ball bar in the vehicle when not in use.

### Driving characteristics and towing tips

Before attaching a trailer, lubricate the coupling ball. However, do not do so if a stabiliser, which acts on the coupling ball, is being used to reduce snaking movements.

For trailers with low driving stability and caravan trailers with a permitted gross vehicle weight of more than 1000 kg a speed of 50 mph must not be exceeded; the use of a stabiliser is recommended.

If the trailer starts snaking, drive more slowly, do not attempt to correct the steering and brake sharply if necessary.

When driving downhill, drive in the same gear as if driving uphill and drive at a similar speed.

Adjust tyre pressure to the value specified for full load ↻ 217.

## Trailer towing

### Trailer loads

The permissible trailer loads are vehicle and engine-dependent maximum values which must not be exceeded. The actual trailer load is the difference between the actual gross weight of the trailer and the actual coupling socket load with the trailer coupled.

The permissible trailer loads are specified in the vehicle documents. In general, they are valid for gradients up to max. 12%.

The permitted trailer loads apply up to the specified incline and up to an altitude of 1000 metres above sea level. Since engine power decreases as altitude increases due to the air becoming thinner, therefore reducing climbing ability, the permissible gross train weight also decreases by 10% for every 1000 metres of additional altitude. The gross train weight does not have to be reduced when driving on roads with slight inclines (less than 8%, e.g. motorways).



The permissible gross train weight must not be exceeded. This weight is specified on the identification plate  
↪ 207.

### Vertical coupling load

The vertical coupling load is the load exerted by the trailer on the coupling ball. It can be varied by changing the weight distribution when loading the trailer.

The maximum permissible vertical coupling load (75 kg) is specified on the towing equipment identification plate and in the vehicle documents. Always aim for the maximum load, especially in the case of heavy trailers. The vertical coupling load should never fall below 25 kg.

### Rear axle load

The permissible axle loads (see identification plate or vehicle documents) must not be exceeded.

## Towing equipment

### Caution

When operating without a trailer, remove the coupling ball bar.

### Stowage of coupling ball bar



The bag with the coupling ball bar is stowed in the rear stowage compartment on the floor.

Place the strap through the lashing eye, wrap around twice and tighten the strap to secure the bag.

## Fitting the coupling ball bar



Disengage and fold down the socket. Remove the sealing plug from the opening for the coupling ball bar and stow it.

### Checking the tensioning of the coupling ball bar



- Red marking on rotary knob must point towards green marking on coupling ball bar.
- The gap between the rotary knob and the coupling ball bar must be approx. 6 mm.
- The key must be in position .

Otherwise, the coupling ball bar must be tensioned before being inserted:

- Unlock coupling ball bar by turning key to position .



- Pull out rotary knob and turn clockwise as far as it will go.

### Inserting the coupling ball bar

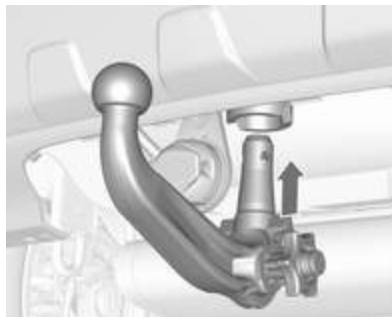

Insert the tensioned coupling ball bar in the opening and push firmly upwards until it audibly engages.

The rotary handle snaps back into its original position resting against the coupling ball bar without a gap.

#### Warning

Do not touch rotary handle during insertion.

Lock the coupling ball bar by turning the key to position . Remove the key and close the protective flap.

### Eye for break-away stopping cable

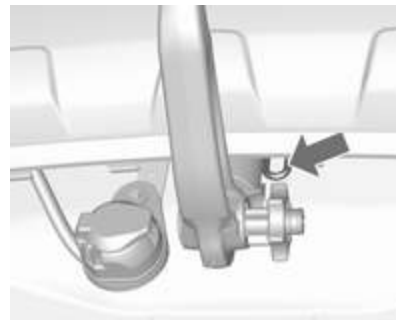

Attach breakaway stopping cable to eye.

**Check that the coupling ball bar is correctly installed**

- Green marking on rotary knob must point towards green marking on coupling ball bar.
- There must be no gap between the rotary handle and the coupling ball bar.
- The coupling ball bar must be firmly engaged in the opening.
- The coupling ball bar must be locked and the key removed.

**⚠ Warning**

Towing a trailer is permitted only when a coupling ball bar is fitted correctly. If the coupling ball bar does not engage correctly, seek the assistance of a workshop.

**Dismounting the coupling ball bar**

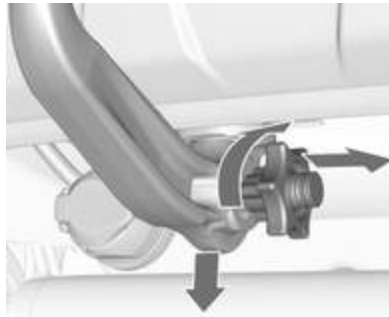

Open the protective flap and turn the key to position  to unlock the coupling ball bar.

Pull out rotary handle and turn clockwise as far as it will go. Pull out coupling ball bar downwards.

Insert sealing plug in opening. Fold away socket.

## Vehicle care

### General Information ..... 163

- Accessories and vehicle modifications ..... 163
- Vehicle storage ..... 163
- End-of-life vehicle recovery ..... 163

### Vehicle checks ..... 164

- Performing work ..... 164
- Bonnet ..... 164
- Engine oil ..... 165
- Engine coolant ..... 166
- Power steering fluid ..... 167
- Washer fluid ..... 167
- Brakes ..... 168
- Brake fluid ..... 168
- Vehicle battery ..... 168
- Diesel fuel system bleeding ..... 170
- Wiper blade replacement ..... 170

### Bulb replacement ..... 171

- Halogen headlights ..... 171
- Xenon headlights ..... 173
- Fog lights ..... 174
- Front turn signal lights ..... 174
- Tail lights ..... 175
- Side turn signal lights ..... 176

- Centre high-mounted brake light ..... 176
- Number plate light ..... 177
- Interior lights ..... 177

### Electrical system ..... 178

- Fuses ..... 178
- Engine compartment fuse box ..... 178
- Instrument panel fuse box ..... 180
- Load compartment fuse box ..... 181

### Vehicle tools ..... 183

- Tools ..... 183

### Wheels and tyres ..... 183

- Winter tyres ..... 183
- Tyre designations ..... 184
- Tyre pressure ..... 184
- Tyre pressure monitoring system ..... 185
- Tread depth ..... 188
- Changing tyre and wheel size ..... 189
- Wheel covers ..... 189
- Tyre chains ..... 189
- Tyre repair kit ..... 190
- Wheel changing ..... 193
- Spare wheel ..... 195

### Jump starting ..... 197

### Towing ..... 199

- Towing the vehicle ..... 199
- Towing another vehicle ..... 200

### Appearance care ..... 201

- Exterior care ..... 201
- Interior care ..... 203

## General Information

### Accessories and vehicle modifications

We recommend the use of genuine parts and accessories and factory approved parts specific for your vehicle type. We cannot assess or guarantee reliability of other products - even if they have a regulatory or otherwise granted approval.

Do not make any modifications to the electrical system, e.g. changes of electronic control units (chip tuning).

<b>Caution</b>
When transporting the vehicle on a train or on a recovery vehicle, the mud flaps might be damaged.

## Vehicle storage

### Storage for a long period of time

If the vehicle is to be stored for several months:

- Wash and wax the vehicle.
- Have the wax in the engine compartment and underbody checked.
- Clean and preserve the rubber seals.
- Fill up fuel tank completely.
- Change the engine oil.
- Drain the washer fluid reservoir.
- Check the coolant antifreeze and corrosion protection.
- Adjust tyre pressure to the value specified for full load.
- Park the vehicle in a dry, well ventilated place. Engage first or reverse gear or set selector lever to **P**. Prevent the vehicle from rolling.
- Do not apply the parking brake.

- Open the bonnet, close all doors and lock the vehicle.
- Disconnect the clamp from the negative terminal of the vehicle battery. Beware that all systems are not functional, e.g. anti-theft alarm system.

### Putting back into operation

When the vehicle is to be put back into operation:

- Connect the clamp to the negative terminal of the vehicle battery. Activate the electronics of the power windows.
- Check tyre pressure.
- Fill up the washer fluid reservoir.
- Check the engine oil level.
- Check the coolant level.
- Fit the number plate if necessary.

### End-of-life vehicle recovery

Information on end-of-life vehicle recovery centres and the recycling of end-of-life vehicles is available on our

website, where legally required. Only entrust this work to an authorised recycling centre.

Gas vehicles must be recycled by a service centre authorised for gas vehicles.

## Vehicle checks

### Performing work



#### **⚠ Warning**

Only perform engine compartment checks when the ignition is off.

The cooling fan may start operating even if the ignition is off.

#### **⚠ Danger**

The ignition system and Xenon headlights use extremely high voltage. Do not touch.

## Bonnet

### Opening



Pull the release lever and return it to its original position.

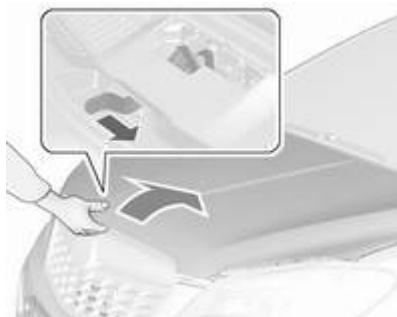

Move the safety catch sideways to the left vehicle side and open the bonnet.

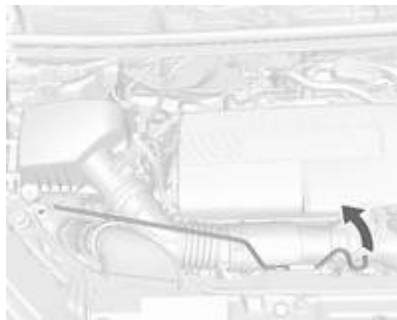

Pull up the support rod lightly from the holder. And then secure it at the left side hook on the bonnet.

If the bonnet is opened during an Autostop, the engine will be restarted automatically for safety reasons.

### Closing

Before closing the bonnet, press the support into the holder.

Lower the bonnet and allow it to fall into the latch from a low height (20-25 cm). Check that the bonnet is engaged.

### Caution

Do not press the bonnet into the latch, to avoid dents.

### Engine oil

Check the engine oil level manually on a regular basis to prevent damage to the engine. Ensure that the correct specification of oil is used. Recommended fluids and lubricants ⇨ 205.

The maximum engine oil consumption is 0.6 l per 1000 km.

Check with the vehicle on a level surface. The engine must be at operating temperature and switched off for at least five minutes.

Pull out the dipstick, wipe it clean, insert it to the stop on the handle, pull out and read the engine oil level.

Insert dipstick to the stop on the handle and make half a turn.



When the engine oil level has dropped to the **MIN** mark, top up engine oil.



We recommend the use of the same grade of engine oil that was used at last change.

The engine oil level must not exceed the **MAX** mark on the dipstick.



The engine oil filler cap is located on the camshaft cover.

### Caution

Overfilled engine oil must be drained or suctioned out.

Capacities ⇨ 216.

Fit the cap on straight and tighten it.

## Engine coolant

The coolant provides freeze protection down to approx.  $-30\text{ }^{\circ}\text{C}$ . In northern countries with very low temperatures the factory filled coolant provides frost protection down to approx.  $-40\text{ }^{\circ}\text{C}$ .

### Caution

Only use approved antifreeze.

## Coolant level

### Caution

Too low a coolant level can cause engine damage.



If the cooling system is cold, the coolant level should be above the filling line mark. Top up if the level is low.



**Warning**

Allow the engine to cool before opening the cap. Carefully open the cap, relieving the pressure slowly.

To top up use a 1:1 mixture of released coolant concentrate mixed with clean tap water. If no coolant concentrate is available, use clean tap water. Install the cap tightly. Have the coolant concentration checked and have the cause of the coolant loss remedied by a workshop.

**Power steering fluid**

**Caution**

Extremely small amounts of contamination can cause steering system damage and cause it to not work properly. Do not allow contaminates to contact the fluid side of the reservoir cap/dipstick or from entering the reservoir.

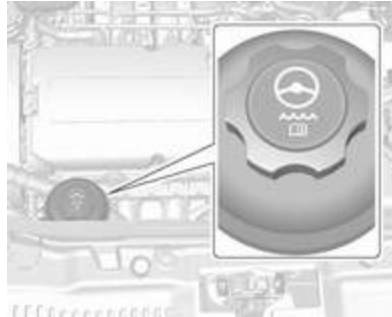

Power steering fluid level normally does not need to be checked. If an unusual noise sounds during steering or the power steering reacts conspicuously, seek the assistance of a workshop.

**Washer fluid**



Fill with clean water mixed with a suitable quantity of approved windscreen washer fluid which contains antifreeze.

**Caution**

Only washer fluid with a sufficient antifreeze concentration provides protection at low temperatures or a sudden drop in temperature.

## Brakes

In the event of minimum thickness of the brake lining, a squealing noise sounds during braking.

Continued driving is possible but have the brake lining replaced as soon as possible.

Once new brake linings are installed, do not brake unnecessarily hard for the first few journeys.

## Brake fluid

### ⚠ Warning

Brake fluid is poisonous and corrosive. Avoid contact with eyes, skin, fabrics and painted surfaces.



The brake fluid level must be between the **MIN** and the **MAX** marks.

If fluid level is below **MIN** seek the assistance of a workshop.

Brake and clutch fluid ↻ 205.

## Vehicle battery

The vehicle battery is maintenance-free provided that the driving profile allows sufficient charging of the battery. Short-distance-driving and frequent engine starts can discharge the battery. Avoid the use of unnecessary electrical consumers.



Batteries do not belong in household waste. They must be disposed of at an appropriate recycling collection point.

Laying up the vehicle for more than four weeks can lead to battery discharge. Disconnect the clamp from the negative terminal of the vehicle battery.

Ensure the ignition is switched off before connecting or disconnecting the vehicle battery.

The anti-theft alarm siren must be deactivated as follows: Switch the ignition on then off, disconnect the vehicle's battery within 15 seconds.

Vehicle battery discharge protection ↻ 115.

## Replacing the vehicle battery

### Notice

Any deviation from the instructions given in this section may lead to temporary deactivation of the stop-start system.

When the vehicle battery is being replaced, please ensure that there are no open ventilation holes in the vicinity of the positive terminal. If a ventilation hole is open in this area, it must be closed off with a dummy cap, and the ventilation in the vicinity of the negative terminal must be opened.

Only use vehicle batteries that allow the fuse box to be mounted above the vehicle battery.

In vehicles with an AGM (Absorptive Glass Mat) battery, make sure to have the battery replaced with another AGM battery.



An AGM battery can be identified by the label on the battery. We recommend the use of an original Vauxhall vehicle battery.

### Notice

Using an AGM vehicle battery different from the original Vauxhall vehicle battery may result in a lower performance.

We recommend that you have the vehicle battery replaced by a workshop.

Stop-start system ⇨ 126.

## Charging the vehicle battery

### ⚠ Warning

On vehicles with stop-start system, ensure that the charging potential does not exceed 14.6 volts when using a battery charger. Otherwise the vehicle battery might be damaged.

Jump starting ⇨ 197.

### Warning label



Meaning of symbols:

- No sparks, naked flames or smoking.
- Always shield eyes. Explosive gases can cause blindness or injury.
- Keep the vehicle battery out of reach of children.
- The vehicle battery contains sulphuric acid which could cause blindness or serious burn injuries.
- See the Owner's Manual for further information.
- Explosive gas may be present in the vicinity of the vehicle battery.

## Diesel fuel system bleeding

If the tank has been run dry, the diesel fuel system must be bled. Switch on the ignition three times for 15 seconds at a time. Then crank the engine for a maximum of 40 seconds. Repeat this process after no less than 5 seconds. If the engine fails to start, seek the assistance of a workshop.

## Wiper blade replacement

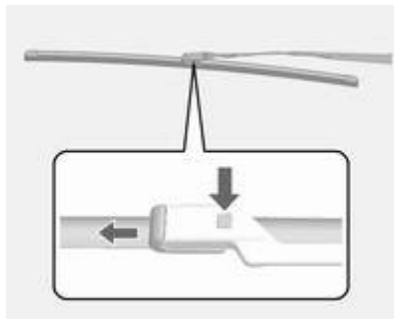

Lift the wiper arm, press button to disengage the wiper blade and remove.

Attach the wiper blade slightly angled to the wiper arm and push until it engages.

Lower wiper arm carefully.

## Wiper blade on the rear window



1. Remove the wiper cover from the wiper assembly.
2. Lift wiper blade.

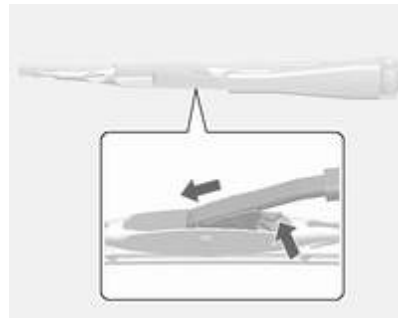

3. Press slider holder pin.
4. Pull wiper blade out.

## Bulb replacement

Switch off the ignition and turn off the relevant switch or close the doors.

Only hold a new bulb at the base. Do not touch the bulb glass with bare hands.

Use only the same bulb type for replacement.

Replace headlight bulbs from within the engine compartment.

## Halogen headlights

### Low beam and high beam



Remove protective cover.

### Low beam



1. Disconnect the headlight bulb socket connector.



2. Press spring clip, disengage it.



3. Remove the bulb from the bulb socket and replace the bulb.
4. When fitting a new bulb, engage the lugs in the recesses on the reflector.
5. Reinstall the headlight assembly.
6. Engage the spring clip.
7. Connect the bulb socket connector.
8. Place headlight protective cover in position and close.

### High beam



1. Remove the bulb socket by pulling.
2. Remove the bulb from the bulb socket and replace the bulb.
3. When fitting a new bulb, engage the lugs in the recesses on the reflector.
4. Reinstall the headlight assembly.
5. Place headlight protective cover in position and close.

### Sidelights



1. Remove the socket from the assembly by turning anticlockwise.
2. Remove bulb socket from reflector.
3. Detach plug connector from bulb.



4. Remove bulb from socket.
5. Insert new bulb.
6. Plug connector onto bulb.
7. Insert socket in reflector.
8. Reinstall the assembly.

## Xenon headlights

**⚠ Danger**

Xenon headlights work under extremely high electrical voltage. Do not touch. Have bulbs replaced by a workshop.

## Cornering lights

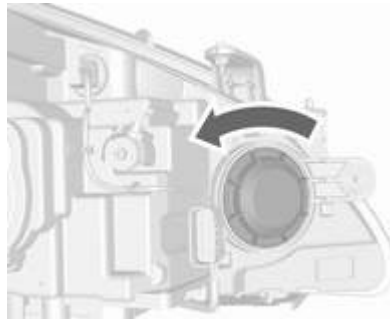

1. Remove the protective cover.



2. Remove the bulb socket by pulling.

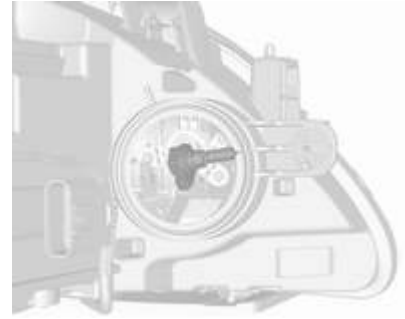

3. Remove the bulb from the bulb socket and replace the bulb.
4. When fitting a new bulb, engage the lugs in the recesses on the reflector.
5. Reinstall the headlight assembly.
6. Place headlight protective cover in position and close.

## Fog lights

The bulbs are accessible from the underside of the vehicle



1. Turn the respective wheel inside to get better access and remove three torx screws on outside of wheel house. Vehicle tools ⇨ 183.
2. Pull and hold lining to get access to the bulb holder.

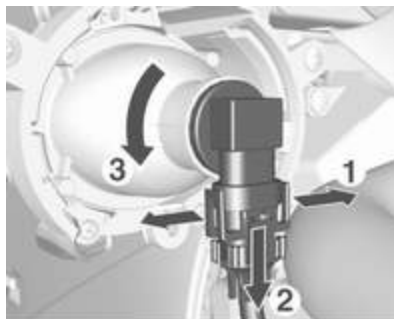

3. Pull the retaining rib (1) outwards and remove plug connector (2) from the bulb socket.
4. Turn the bulb holder anticlockwise (3) and remove it from the reflector.
5. Remove and replace the bulb socket with bulb and attach the plug connector.
6. Insert the bulb socket into the reflector by turning clockwise and engage.
7. Re-assemble the lining and fasten the three torx screws.

## Front turn signal lights



1. Rotate bulb holder anticlockwise and disengage.

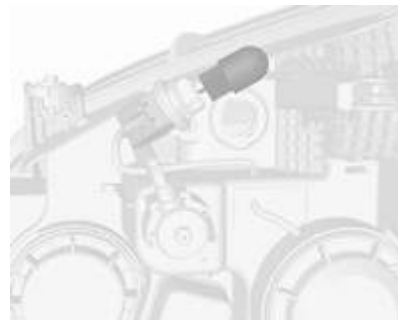



2. Push bulb into socket slightly, rotate anticlockwise, remove and renew bulb.
3. Insert bulb holder in reflector, rotate clockwise to engage.

## Tail lights

### Left-hand side

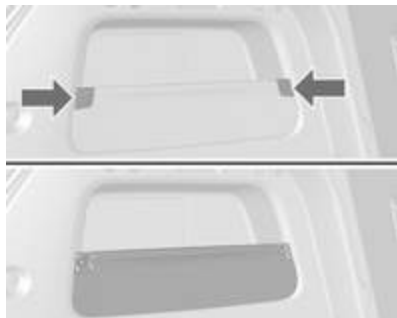

1. Disengage both covers at the respective outer side by inserting a screwdriver. Remove both covers and unscrew screws. Remove the panel.



2. First disengage cover by inserting a screwdriver at the recess. Then disengage cover at the front and upper side. Remove cover.

### Right-hand side



1. Remove the storage door and the tyre repair kit.



2. Remove the cover.

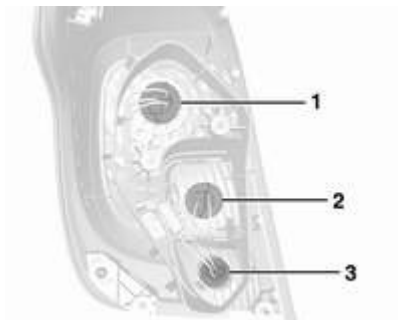

3. Tail/Stop light (1)  
Turn signal light (2)  
Back-up lamp (3)



4. Remove bulb holder. Remove and renew bulb.
5. Insert bulb holder into the tail light assembly. Close covers and engage.
6. Switch on ignition, operate and check all lights.

### Side turn signal lights



If the lights do not operate, have them checked by a workshop.

### Centre high-mounted brake light



If the centre high-mounted brake light does not operate, have it checked by a workshop.

## Number plate light



1. Prise the light out with a screwdriver.
2. Remove bulb housing downwards, taking care not to pull on the cable.  
Rotate bulb holder anticlockwise to disengage.
3. Remove bulb from holder and renew bulb.
4. Insert bulb holder in bulb housing and rotate clockwise.
5. Insert bulb housing and secure using a screwdriver.

## Interior lights

### Courtesy lights

1. To remove it, prise the opposite side of the light switch using a flat-blade screwdriver.
2. Remove the bulb.
3. Replace the bulb.
4. Reinstall the light assembly.

### Load compartment light

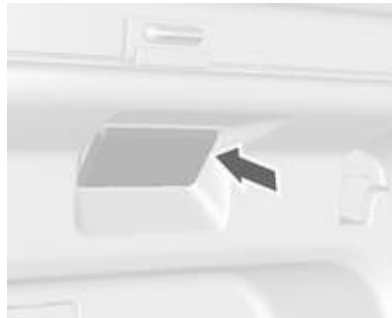

1. Prise the light out with a screwdriver.
2. Remove bulb.

3. Insert new bulb.
4. Install light.

## Electrical system

### Fuses

Data on the replacement fuse must match the data on the defective fuse.

In a box above the positive terminal of the battery are some main fuses. If necessary have them changed by a workshop.

Before replacing a fuse, turn off the respective switch and the ignition.

A blown fuse can be recognised by its melted wire. Do not replace the fuse until the cause of the fault has been remedied.

Some functions are protected by several fuses.

Fuses may also be inserted without existence of a function.

#### Notice

Not all fuse box descriptions in this manual may apply to your vehicle.

When inspecting the fuse box, refer to the fuse box label.

### Fuse extractor

A fuse extractor may be located in the fuse box in the engine compartment.

Place the fuse extractor on the various types of use from the top or side, and withdraw fuse.

### Engine compartment fuse box

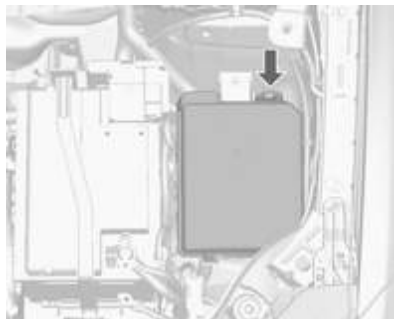

The fuse box is in the engine compartment.

Disengage the cover, lift it upwards and remove.



### Mini Fuses

**No. Circuit**

- 
- 1 Sunroof
  - 2 Exterior mirrors
  - 3 –
  - 4 –
  - 5 Electrical brake control module
  - 6 Intelligent battery sensor
  - 7 –
  - 8 Transmission control module
  - 9 –
  - 10 Headlight levelling
  - 11 Rear window wiper
  - 12 Heated rear window
  - 13 Headlight actuator (left hand)
  - 14 Heated exterior mirrors
  - 15 –
  - 16 Seat heating
  - 17 Transmission control module

**No. Circuit**

- 
- 18 Engine control module
  - 19 Fuel pump
  - 20 –
  - 21 Cooling fan
  - 22 –
  - 23 Ignition coil/Engine control module
  - 24 Washer pump
  - 25 Headlamp actuator (right hand)
  - 26 Engine control sensors
  - 27 –
  - 28 Ignition
  - 29 Ignition
  - 30 Exhaust system
  - 31 Left-hand high beam
  - 32 Right-hand high beam
  - 33 Engine control module
  - 34 Horn

**No. Circuit**

- 
- 35 Air conditioning system
  - 36 Front fog lamp

**J-cases Fuses****No. Circuit**

- 
- 1 Electrical brake control module
  - 2 Front wiper
  - 3 Power module
  - 4 Power terminal of instrument panel fuse box
  - 5 –
  - 6 Fuel heater
  - 7 –
  - 8 Cooling fan
  - 9 Cooling fan
  - 10 Engine control module/Glow plug
  - 11 Starter

## Instrument panel fuse box



Interior fuse block is located on the underside of the driver's side instrument panel.

To access the fuses, remove the storage.

To remove the storage, open and pull it.

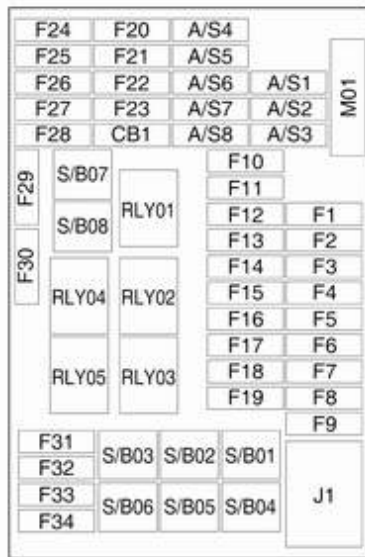

## Mini Fuses

## No. Circuit

- 1 Body control module
- 2 Body control module
- 3 Body control module
- 4 Body control module
- 5 Body control module
- 6 Body control module
- 7 Body control module
- 8 Body control module
- 9 Ignition switch
- 10 Safety diagnosis module
- 11 Data link connector
- 12 Climate control
- 13 Tailgate
- 14 Parking assist
- 15 Lane departure warning/Interior mirror
- 16 Adaptive forward lighting
- 17 Power window driver

**No. Circuit**

- 18 Rain sensor
- 19 Body control module/Regulated voltage control
- 20 Steering wheel
- 21 AC accessory power outlet/  
Automatic transmission
- 22 Cigarette lighter/DC accessory power outlet
- 23 Spare
- 24 Spare
- 25 Spare
- 26 Spare
- 27 Instrument panel cluster/Auxiliary heater/Clutch switch
- 28 Adaptive forward lighting/  
Voltage converter/Headlamp switch
- 29 Spare
- 30 Spare

**No. Circuit**

- 31 Instrument panel cluster
- 32 Infotainment system/Chime
- 33 Display/Infotainment system
- 34 Onstar UHP/DAB

**S/B Fuses****No. Circuit**

- 01 Spare
- 02 Spare
- 03 Power windows front
- 04 Power windows rear
- 05 Logistic mode
- 06 Spare
- 07 Spare
- 08 Spare

**Load compartment fuse box**

Located in the left side of rear compartment.

To access the fuses, remove the cover.

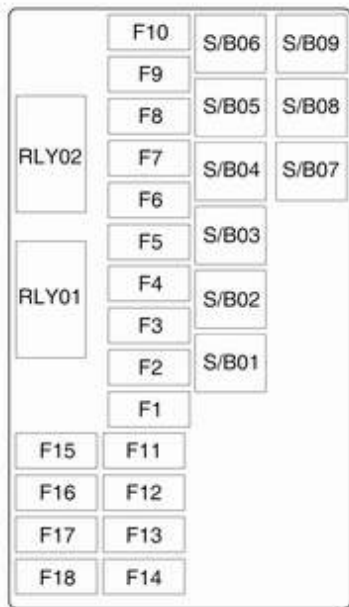

Mini Fuses

### No. Circuit

---

- 1 Seat, lumbar support, driver
- 2 Seat, lumbar support, passenger
- 3 Amplifier
- 4 Trailer socket
- 5 All-wheel drive
- 6 Spare
- 7 LPG system
- 8 Spare
- 9 Spare
- 10 Spare
- 11 Trailer control module
- 12 Spare
- 13 Heated steering wheel
- 14 Trailer socket
- 15 Spare
- 16 Water in fuel sensor

### No. Circuit

---

- 17 Interior mirror/Rear view camera
- 18 LPG system

### S/B Fuses

#### No. Circuit

---

- 1 Power seat driver
- 2 Power seat passenger
- 3 Trailer control module
- 4 Voltage converter
- 5 Battery
- 6 Headlight washer
- 7 Spare
- 8 Spare
- 9 Spare



## Vehicle tools

### Tools

#### Vehicles with tyre repair kit



The tools and tyre repair kit are in the right side of the load compartment.  
 ⇨ 190.

#### Vehicles with spare wheel



The jack and the tools are in a storage compartment in the load compartment above the spare wheel.

Wheel changing ⇨ 193, spare wheel ⇨ 195.

## Wheels and tyres

### Tyre condition, wheel condition

Drive over edges slowly and at right angles if possible. Driving over sharp edges can cause tyre and wheel damage. Do not trap tyres on the kerb when parking.

Regularly check the wheels for damage. Seek the assistance of a workshop in the event of damage or unusual wear.

### Winter tyres

Winter tyres improve driving safety at temperatures below 7 °C and should therefore be fitted on all wheels.

All tyre sizes are permitted as winter tyres ⇨ 217.

In accordance with country-specific regulations, affix the speed sticker in the driver's field of view.

## Tyre designations

E.g. **215/60 R 16 95 H**

**215** : tyre width, mm

**60** : cross-section ratio (tyre height to tyre width), percentage

**R** : belt type: Radial

**RF** : type: RunFlat

**16** : wheel diameter, inches

**95** : load index e.g. 95 is equivalent to 690 kg

**H** : speed code letter

Speed code letter:

**Q** : up to 100 mph

**S** : up to 112 mph

**T** : up to 118 mph

**H** : up to 130 mph

**V** : up to 150 mph

**W** : up to 168 mph

Choose a tyre appropriate for the maximum speed of your vehicle.

The maximum speed is achievable at kerb weight with driver (75 kg) plus 125 kg payload. Optional equipment could reduce the maximum speed of the vehicle.

Performance ⇨ 213.

## Directional tyres

Fit directional tyres such that they roll in the direction of travel. The rolling direction is indicated by a symbol (e.g. an arrow) on the sidewall.

## Tyre pressure

Check the pressure of cold tyres at least every 14 days and before any long journey. Do not forget the spare wheel. This also applies to vehicles with tyre pressure monitoring system.

Unscrew the valve cap.



Tyre pressure ⇨ 217.

The tyre pressure information label on the left or right door frame indicates the original equipment tyres and the correspondent tyre pressures.

The tyre pressure data refers to cold tyres. It applies to summer and winter tyres.

Always inflate the spare tyre to the pressure specified for full load.

The ECO tyre pressure serves to achieve the smallest amount of fuel consumption possible.

Incorrect tyre pressures will impair safety, vehicle handling, comfort and fuel economy and will increase tyre wear.

Tyre pressures differ depending on various options. For the correct tyre pressure value, follow the procedure below:

1. Identify the engine identifier code.  
Engine data ⇨ 212.
2. Identify the respective tyre.

The tyre pressure tables show all possible tyre combinations ⇨ 217.

For the tyres approved for your vehicle, refer to the EEC Certificate of Conformity provided with your vehicle or other national registration documents.

The driver is responsible for correct adjustment of tyre pressure.

**⚠ Warning**

If the pressure is too low, this can result in considerable tyre warm-up and internal damage, leading to tread separation and even to tyre blow-out at high speeds.

**⚠ Warning**

For specific tyres the recommended tyre pressure as shown in the tyre pressure table may exceed the maximum tyre pressure as indicated on the tyre. Never exceed the maximum tyre pressure as indicated on the tyre.

**Temperature dependency**

The tyre pressure depends on the temperature of the tyre. During driving, tyre temperature and pressure increase. Tyre pressure values provided on the tyre information label and tyre pressure chart are valid for cold tyres, which means at 20 °C.

The pressure increases by nearly 1.5 psi for a 10 °C temperature increase. This must be considered when warm tyres are checked.

The tyre pressure value displayed in the Driver Information Centre shows the real tyre pressure. A cooled down tyre will show a decreased value, which does not indicate an air leak.

**Tyre pressure monitoring system**

The tyre pressure monitoring system checks the pressure of all four tyres once a minute when vehicle speed exceeds a certain limit.

**Caution**

Tyre pressure monitoring system warns only about low tyre pressure condition and does not replace regular tyre maintenance by the driver.

All wheels must be equipped with pressure sensors and the tyres must have the prescribed pressure.

**Notice**

In countries where the tyre pressure monitoring system is legally required, the use of wheels without pressure sensors will invalidate the vehicle type approval.

The current tyre pressures can be shown in the **Vehicle Information Menu** in the Driver Information Centre.

The menu can be selected by the buttons on the turn signal lever.

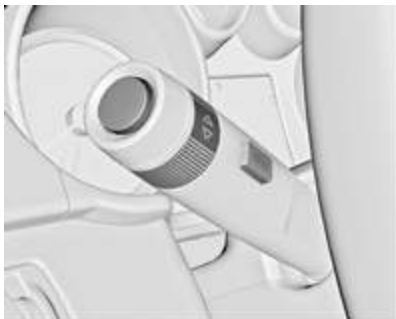

Press **MENU** to select the **Vehicle Information Menu** .

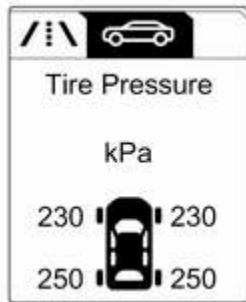

Turn the adjuster wheel to select the tyre pressure monitoring system.

System status and pressure warnings are displayed by a message with the corresponding tyre flashing in the Driver Information Centre.

The system considers the tyre temperature for the warnings.

Temperature dependency ⇨ 184.



A detected low tyre pressure condition is indicated by the control indicator  ⇨ 86.

If  illuminates, stop as soon as possible and inflate the tyres as recommended ⇨ 217.

If  flashes for 60-90 seconds and then illuminates continuously, there is a fault in the system. Consult a workshop.

After inflating, driving may be required to update the tyre pressure values in the Driver Information Centre. During this time  may illuminate.

If  illuminates at lower temperatures and extinguishes after some driving, this could be an indicator for approaching a low tyre pressure condition. Check tyre pressure.

Vehicle messages ⇨ 93.

If the tyre pressure shall be reduced or increased, switch off ignition.

Only mount wheels with pressure sensors, otherwise the tyre pressure will not be displayed and  illuminates continuously.

A temporary spare wheel is not equipped with pressure sensors. The tyre pressure monitoring system is not operational for these wheels.

Control indicator  illuminates. For the further three wheels the system remains operational.

The use of commercially available liquid tyre repair kits can impair the function of the system. Factory-approved repair kits can be used.

Operating electronic devices or being close to facilities using similar wave frequencies could disrupt the tyre pressure monitoring system.

Each time the tyres are replaced, tyre pressure monitoring system sensors must be dismantled and serviced. For the screwed sensor, replace valve core and sealing ring. For clipped sensor, replace complete valve stem.

### Vehicle loading status

Adjust tyre pressure to load condition according to tyre information label or tyre pressure chart ↻ 217, and select the relevant setting in the menu **Tyre Load** in the Driver Information Centre, **Vehicle Information Menu** ↻ 88. This setting is the reference for the tyre pressure warnings.

The **Tyre Load** menu only appears if the vehicle is in a standstill and the parking brake is applied. On vehicles with automatic transmission the selector lever has to be in **P**.

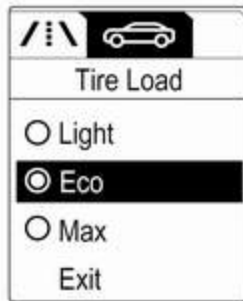

Select:

- **Light** for comfort pressure up to 3 people
- **Eco** for Eco pressure up to 3 people
- **Max** for full loading

### Tyre pressure sensor matching process

Each tyre pressure sensor has a unique identification code. The identification code must be matched to a new wheel position after rotating the wheels or exchanging the complete wheel set and if one or more tyre pressure sensors were replaced. The tyre pressure sensor matching process should also be performed after replacing a spare wheel with a road wheel containing the tyre pressure sensor.

The malfunction light (⚠) and the warning message or code should go off at the next ignition cycle. The sensors are matched to the wheel positions, using a relearn tool, in the following order: left side front wheel, right side front wheel, right side rear wheel and left side rear wheel. The turn signal light at the current active position is illuminated until sensor is matched.

Consult a workshop for service or purchase a relearn tool. There are two minutes to match the first wheel position, and five minutes overall to

match all four wheel positions. If it takes longer, the matching process stops and must be restarted.

The tyre pressure sensor matching process is:

1. Apply the parking brake.
2. Turn the ignition on.
3. On vehicles with automatic transmission: set the selector lever to **P**.  
On vehicles with manual transmission: select neutral.
4. Press **MENU** on the turn signal lever to select the **Vehicle Information Menu** in the Driver Information Centre.
5. Turn the adjuster wheel to scroll to the tyre pressure menu.
6. Press **SET/CLR** to begin the sensor matching process. A message requesting acceptance of the process should display.
7. Press **SET/CLR** again to confirm the selection. The horn sounds twice to signal the receiver is in relearn mode.
8. Start with the left side front wheel.

9. Place the relearn tool against the tyre sidewall, near the valve stem. Then press the button to activate the tyre pressure sensor. A horn chirp confirms that the sensor identification code has been matched to this tyre and wheel position.
10. Proceed to the right side front wheel, and repeat the procedure in Step 9.
11. Proceed to the right side rear wheel, and repeat the procedure in Step 9.
12. Proceed to the left side rear wheel, and repeat the procedure in Step 9. The horn sounds twice to indicate the sensor identification code has been matched to the driver side rear wheel, and the tyre pressure sensor matching process is no longer active.
13. Turn off the ignition.

14. Set all four tyres to the recommended air pressure level as indicated on the tyre pressure information label.
15. Ensure the tyre loading status is set according selected pressure ⇨ 88.

## Tread depth

Check tread depth at regular intervals.

Tyres should be replaced for safety reasons at a tread depth of 2-3 mm (4 mm for winter tyres).

For safety reasons it is recommended that the tread depth of the tyres on one axle should not vary by more than 2 mm.



The legally permissible minimum tread depth (1.6 mm) has been reached when the tread has worn down as far as one of the tread wear indicators (TWI). Their position is indicated by markings on the sidewall.

If there is more wear at the front than the rear, swap round front wheels and rear wheels. Ensure that the direction of rotation of the wheels is the same as before.

Tyres age, even if they are not used. We recommend tyre replacement every six years.

## Changing tyre and wheel size

If tyres of a different size than those fitted at the factory are used, it may be necessary to reprogramme the speedometer as well as the nominal tyre pressure and make other vehicle modifications.

After converting to a different tyre size, have the label with tyre pressures replaced.

### ⚠ Warning

Use of unsuitable tyres or wheels may lead to accidents and will invalidate the vehicle type approval.

## Wheel covers

Wheel covers and tyres that are factory-approved for the respective vehicle and comply with all of the relevant wheel and tyre combination requirements must be used.

If the wheel covers and tyres used are not factory-approved, the tyres must not have a rim protection ridge.

Wheel covers must not impair brake cooling.

### ⚠ Warning

Use of unsuitable tyres or wheel covers could lead to sudden pressure loss and thereby accidents.

Vehicles with alloy wheels: When mounting steel wheels with alloy wheel nuts, e.g. when changing to winter tyres, the wheel covers cannot be attached to the steel wheels.

## Tyre chains



Use tyre chains only on front wheels.

**⚠ Warning**

Damage may lead to tyre blowout.

Tyre chains are permitted on tyres of size 215/65 R16, 215/60 R17 and 215/55 R18.

On tyres of size 215/65 R16 always use fine mesh chains suitable for sport utility vehicles that add no more than 9 mm to the tyre tread and the inboard sides (including chain lock).

On tyres of size 215/60 R17 and 215/55 R18 only use special snow chains which are permitted for Vauxhall Mokka and tyres of these sizes. For further information contact a workshop.

The use of tyre chains is not permitted on the temporary spare wheel.

## Tyre repair kit

Minor damage to the tyre tread can be repaired with the tyre repair kit.

Do not remove foreign bodies from the tyres.

Tyre damage exceeding 4 mm or that is at tyre's sidewall cannot be repaired with the tyre repair kit.

**⚠ Warning**

Do not drive faster than 50 mph.  
Do not use for a lengthy period.  
Steering and handling may be affected.

If you have a flat tyre:

Apply the parking brake and engage first gear, reverse gear or **P**.



The tyre repair kit is located in the right side of rear compartment.



1. Take the tyre repair kit from the compartment.
2. Remove the compressor.

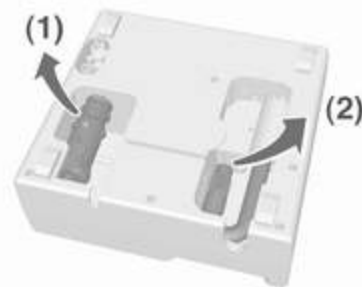



- Remove the electrical connection cable (1) and air hose (2) from the stowage compartments on the underside of the compressor.



- Screw the compressor air hose to the connection on the sealant bottle.
- Fit the sealant bottle into the retainer on the compressor.  
Set the compressor near the tyre in such a way that the sealant bottle is upright.



- Unscrew valve cap from defective tyre.
- Screw the filler hose to the tyre valve.
- The switch on the compressor must be set to O.
- Connect the compressor plug to the power outlet or cigarette lighter socket.

To avoid discharging the battery, we recommend running the engine.



- Set the rocker switch on the compressor to I. The tyre is filled with sealant.
- The compressor pressure gauge briefly indicates up to 6 bar whilst the sealant bottle is emptying (approx. 30 seconds). Then the pressure starts to drop.
- All of the sealant is pumped into the tyre. Then the tyre is inflated.
- The prescribed tyre pressure should be obtained within ten minutes. Tyre pressure  $\varnothing$  217. When the correct pressure is obtained, switch off the compressor.



If the prescribed tyre pressure is not obtained within ten minutes, remove the tyre repair kit. Move the vehicle one tyre rotation. Reattach the tyre repair kit and continue the filling procedure for 10 minutes. If the prescribed tyre pressure is still not obtained, the tyre is too badly damaged. Seek the assistance of a workshop.

Drain excess tyre pressure with the button over the pressure indicator.

Do not run the compressor longer than 10 minutes.

14. Detach the tyre repair kit. Push catch on bracket to remove sealant bottle from bracket. Screw the tyre inflation hose to the free connection of the sealant bottle. This prevents sealant from escaping. Stow tyre repair kit in load compartment.
15. Remove any excess sealant using a cloth.
16. Take the label indicating maximum permitted speed from the sealant bottle and affix in the driver's field of view.
17. Continue driving immediately so that sealant is evenly distributed in the tyre. After driving approx. 6 miles (but no more than ten minutes), stop and check tyre pressure. Screw compressor air hose directly onto tyre valve and compressor when doing this.



If tyre pressure is more than 1.3 bar, set it to the correct value. Repeat the procedure until there is no more loss of pressure.

If the tyre pressure has fallen below 1.3 bar, the vehicle must not be used. Seek the assistance of a workshop.

18. Stow away tyre repair kit in load compartment.

**Notice**

The driving characteristics of the repaired tyre are severely affected, therefore have this tyre replaced.

If unusual noise is heard or the compressor becomes hot, turn compressor off for at least 30 minutes.

The built-in safety valve opens at a pressure of 102 psi.

Note the expiry date of the kit. After this date its sealing capability is no longer guaranteed. Pay attention to storage information on sealant bottle.

Replace the used sealant bottle. Dispose of the bottle as prescribed by applicable laws.

The compressor and sealant can be used from approx. -30 °C.

The adapters supplied can be used to pump up other items e.g. footballs, air mattresses, inflatable dinghies etc. They are located on the underside of the compressor. To remove, screw on compressor air hose and withdraw adapter.

**Wheel changing**

Some vehicles are equipped with a tyre repair kit instead of a spare wheel ⇨ 190.

Make the following preparations and observe the following information:

- Park the vehicle on a level, firm and non-skid surface. The front wheels must be in the straight-ahead position.
- Apply the parking brake and engage first gear, reverse gear or **P**.
- Remove the spare wheel ⇨ 195.
- Never change more than one wheel at a time.
- Use the jack only to change wheels in case of puncture, not for seasonal winter or summer tyre change.
- The jack is maintenance-free.
- If the ground on which the vehicle is standing is soft, a solid board (max. 1 cm thick) should be placed under the jack.
- Take heavy objects out of the vehicle before jacking up.

- No people or animals may be in the vehicle when it is jacked-up.
- Never crawl under a jacked-up vehicle.
- Do not start the vehicle when it is raised on the jack.
- Clean wheel nuts and thread with a clean cloth before mounting the wheel.

**⚠ Warning**

Do not grease wheel bolt, wheel nut and wheel nut cone.

1. Disengage wheel nut caps with a screwdriver and remove. Pull off the wheel cover.



2. Fold out the wheel wrench and install ensuring that it locates securely and loosen each wheel nut by half a turn.

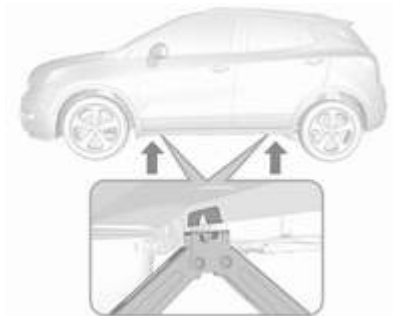

3. Ensure the jack is correctly positioned under the relevant vehicle jacking point.

Depending on the equipment, first remove the covers from the jacking points.

4. Set the jack to the necessary height. Position it directly below the jacking point in a manner that prevents it from slipping.



Attach wheel wrench and with the jack correctly aligned rotate wheel wrench until wheel is clear of the ground.

5. Unscrew the wheel nuts.  
6. Change the wheel. Spare wheel  $\varnothing$  195.

7. Screw on the wheel nuts.  
8. Lower the vehicle and remove jack.  
9. Install the wheel wrench ensuring that it locates securely and tighten each nut in a crosswise sequence. Tightening torque is 140 Nm.  
10. Align the valve hole in the wheel cover with the tyre valve before installing.

Install wheel nut caps.

Install centre cap on alloy wheels.

11. Install vehicle jacking point cover on versions with sill panelling.  
12. Stow the replaced wheel  $\varnothing$  195 and the vehicle tools  $\varnothing$  183.  
13. Check the tyre pressure of the installed tyre and the wheel nut torque as soon as possible.

Have the defective tyre renewed or repaired as soon as possible.

### Jacking position for lifting platform



Rear arm position of the lifting platform centrally under the recess of the sill.



Front arm position of the lifting platform at the underbody.

### Spare wheel

Some vehicles are equipped with a tyre repair kit instead of a spare wheel ⇨ 190.

If mounting a spare wheel, which is different from the other wheels, this wheel might be classified as a temporary spare wheel and the corresponding speed limits apply, even though no label indicates this. Seek the assistance of a workshop to check the applicable speed limit.

The spare wheel has a steel rim.

#### Caution

The use of a spare wheel that is smaller than the other wheels or in combination with winter tyres could affect driveability. Have the defective tyre replaced as soon as possible.



The spare wheel is located in the load compartment beneath the floor covering. It is secured with a wing nut.

### Stowing a damaged full size wheel in the load compartment

The spare wheel well is not designed for other tyre sizes than the spare wheel.

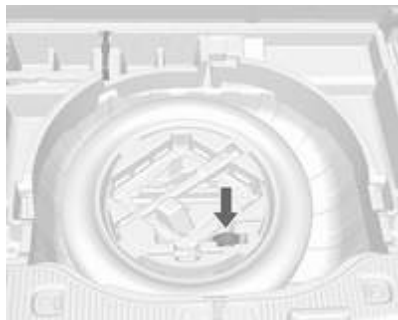

A damaged full size wheel must be stowed in the load compartment and secured with a strap. Vehicle tools ⇨ 183.

To secure the wheel:

1. Position the wheel in the middle of the load compartment.
2. Place the loop end of the strap through the lashing eye on one side.
3. Place the hook end of the strap through the loop and pull it until the strap is fastened securely to the lashing eye.



4. Insert the strap through the spokes of the wheel as shown in the illustration.
5. Mount the hook to the opposite lashing eye.
6. Tighten the strap and secure it using the buckle.

#### **⚠ Danger**

Always drive with folded up and engaged rear seat backrests when stowing a damaged full size wheel in the load compartment.

## Temporary spare wheel

### Caution

The use of the temporary spare wheel could affect driveability. Have the defective tyre renewed or repaired as soon as possible.

Only mount one temporary spare wheel. Do not drive faster than 50 mph. Take curves slowly. Do not use for a long period of time.

If your vehicle gets a flat tyre on the rear while towing another vehicle, mount the temporary spare wheel at the front and the full size tyre at the rear.

Tyre chains ⇨ 189.

## Spare wheel with directional tyre

If possible, fit directional tyres such that they roll in the direction of travel. The rolling direction is indicated by a symbol (e.g. an arrow) on the sidewall.

The following applies to tyres fitted opposing the rolling direction:

- Driveability may be affected. Have the defective tyre renewed or repaired as soon as possible and fit it instead of the spare wheel.
- Drive particularly carefully on wet and snow-covered road surfaces.

## Jump starting

Do not start with a quick charger.

A vehicle with a discharged battery can be started using jump leads and the battery of another vehicle.

### Warning

Be extremely careful when starting with jump leads. Any deviation from the following instructions can lead to injuries or damage caused by battery explosion or damage to the electrical systems of both vehicles.

### Warning

Avoid contact of the battery with eyes, skin, fabrics and painted surfaces. The fluid contains sulphuric acid which can cause injuries and damage in the event of direct contact.

- Never expose the battery to naked flames or sparks.

- A discharged battery can already freeze at a temperature of 0 °C. Defrost the frozen battery before connecting jump leads.
- Wear eye protection and protective clothing when handling a battery.
- Use a booster battery with the same voltage (12 Volts). Its capacity (Ah) must not be much less than that of the discharged battery.
- Use jump leads with insulated terminals and a cross section of at least 16 mm<sup>2</sup> (25 mm<sup>2</sup> for diesel engines).
- Do not disconnect the discharged battery from the vehicle.
- Switch off all unnecessary electrical consumers.
- Do not lean over the battery during jump starting.
- Do not allow the terminals of one lead to touch those of the other lead.
- The vehicles must not come into contact with each other during the jump starting process.

- Apply the parking brake, transmission in neutral, automatic transmission in **P**.
- Open the positive terminal protection caps of both batteries.



Lead connection order:

1. Connect the red lead to the positive terminal of the booster battery.
2. Connect the other end of the red lead to the positive terminal of the discharged battery.

3. Connect the black lead to the negative terminal of the booster battery.
4. Connect the other end of the black lead to a vehicle grounding point, such as the engine block or an engine mounting bolt. Connect as far away from the discharged battery as possible, however at least 60 cm.

Route the leads so that they cannot catch on rotating parts in the engine compartment.

To start the engine:

1. Start the engine of the vehicle providing the jump.
2. After five minutes, start the other engine. Start attempts should be made for no longer than 15 seconds at an interval of 1 minute.
3. Allow both engines to idle for approx. three minutes with the leads connected.

4. Switch on electrical consumers (e.g. headlights, heated rear window) of the vehicle receiving the jump start.
5. Reverse above sequence exactly when removing leads.



## Towing

### Towing the vehicle



Disengage cap by using a screwdriver and remove.

The towing eye is stowed with the vehicle tools ⇨ 183.



Screw in the towing eye as far as it will go until it stops in a horizontal position.

Attach a tow rope – or better still a tow rod – to the towing eye.

The towing eye must only be used for towing and not for recovering the vehicle.

Switch on ignition to release steering wheel lock and to permit operation of brake lights, horn and windscreen wiper.

Transmission in neutral.

#### Caution

Never tow a vehicle equipped with All Wheel Drive (AWD) with the front or rear tyres on the road. If you tow a vehicle equipped with AWD while the front or rear tyres are rolling on the road, the drive system in the vehicle could be severely damaged. When towing vehicles equipped with AWD, all four tyres must not be in contact with the road.

#### Caution

Drive slowly. Do not drive jerkily. Excessive tractive force can damage the vehicle.

When the engine is not running, considerably more force is needed to brake and steer.

To prevent the entry of exhaust gases from the towing vehicle, switch on the air recirculation system ⇨ 117 and close the windows.

Vehicles with manual transmission:  
The vehicle must be towed facing forwards. The maximum speed is 50 mph. In all other cases, and when the transmission is defective, the front axle must be raised off the ground.

Vehicles with automatic transmission:  
Do not tow the vehicle using a towing eye. Towing with a tow rope could cause severe automatic transmission damage. When towing vehicles with automatic transmission, use flat bed or wheel lift equipment.

Seek the assistance of a workshop.  
After towing, unscrew the towing eye.  
Insert cap and close cap.

## Towing another vehicle



Disengage the cap by using a screwdriver and remove.

The towing eye is stowed with the vehicle tools ⇨ 183.



Screw in the towing eye as far as it will go until it stops in a horizontal position.

The lashing eye at the rear underneath the vehicle must never be used as a towing eye.

Attach a tow rope – or even better a tow bar – to the towing eye.

The towing eye must only be used for towing and not for recovering a vehicle.

**Caution**

Drive slowly. Do not drive jerkily.  
Excessive tractive force can  
damage the vehicle.

After towing, unscrew the towing eye.  
Insert cap at the bottom and engage  
cap.

**Appearance care****Exterior care****Locks**

The locks are lubricated at the factory using a high quality lock cylinder grease. Use de-icing agent only when absolutely necessary, as this has a degreasing effect and impairs lock function. After using a de-icing agent, have the locks regreased by a workshop.

**Washing**

The paintwork of your vehicle is exposed to environmental influences. Wash and wax your vehicle regularly. When using automatic vehicle washes, select a programme that includes waxing.

Bird droppings, dead insects, resin, pollen and the like should be cleaned off immediately, as they contain aggressive constituents which can cause paint damage.

If using a vehicle wash, comply with the vehicle wash manufacturer's instructions. The windscreen wiper and rear window wiper must be switched off. Remove antenna and external accessories such as roof racks etc.

If you wash your vehicle by hand, make sure that the insides of the wheel housings are also thoroughly rinsed out.

Clean edges and folds on opened doors and the bonnet as well as the areas they cover.

**Caution**

Always use a cleaning agent with a pH value of 4 to 9.

Do not use cleaning agents on hot surfaces.

Have the door hinges of all doors greased by a workshop.

Do not clean the engine compartment with a steam-jet or high-pressure jet cleaner.

Thoroughly rinse and leather-off the vehicle. Rinse leather frequently. Use separate leathers for painted and glass surfaces: remnants of wax on the windows will impair vision.

### Exterior lights

Headlight and other light covers are made of plastic. Do not use any abrasive or caustic agents, do not use an ice scraper, and do not clean them dry.

### Polishing and waxing

Wax the vehicle regularly (at the latest when water no longer beads). Otherwise, the paintwork will dry out.

Polishing is necessary only if the paint has become dull or if solid deposits have become attached to it.

Paintwork polish with silicone forms a protective film, making waxing unnecessary.

Plastic body parts must not be treated with wax or polishing agents.

### Windows and windscreen wiper blades

Use a soft lint-free cloth or chamois leather together with window cleaner and insect remover.

When cleaning the rear window from inside, always wipe in parallel to the heating element to prevent damage.

For mechanical removal of ice, use a sharp-edged ice scraper. Press the scraper firmly against the glass so that no dirt can get under it and scratch the glass.

Clean smearing wiper blades with a soft cloth and window cleaner.

Remove dirt residues from smearing wiper blades by using a soft cloth and window cleaner. Also make sure to remove any residues such as wax, insect residues and similar from the window.

Ice residues, pollution and continuous wiping on dry windows will damage or even destroy the wiper blades.

### Wheels and tyres

Do not use high-pressure jet cleaners.

Clean rims with a pH-neutral wheel cleaner.

Rims are painted and can be treated with the same agents as the body.

### Paintwork damage

Rectify minor paintwork damage with a touch-up pen before rust forms. Have more extensive damage or rust areas repaired by a workshop.

### Underbody

Some areas of the vehicle underbody have a PVC undercoating while other critical areas have a durable protective wax coating.

After the underbody is washed, check the underbody and have it waxed if necessary.

Bitumen/rubber materials could damage the PVC coating. Have underbody work carried out by a workshop.

Before and after winter, wash the underbody and have the protective wax coating checked.

### Liquid gas system

#### Danger

Liquid gas is heavier than air and can collect in sink points.

Take care when performing work at the underbody in a pit.

For painting work and when using a drying booth at a temperature above 60 °C, the liquid gas system must be completely evacuated.

Do not make any modifications to the liquid gas system.

### Towing equipment

Do not clean the coupling ball bar with a steam-jet or high-pressure jet cleaner.

### Rear carrier system

Clean the rear carrier system with a steam-jet or high-pressure jet cleaner at least once a year.

Operate the rear carrier system periodically if not in regular use, in particular during winter.

## Interior care

### Interior and upholstery

Only clean the vehicle interior, including the instrument panel fascia and panelling, with a dry cloth or interior cleaner.

Clean the leather upholstery with clear water and a soft cloth. In case of heavy soiling, use leather care.

The instrument cluster and the displays should only be cleaned using a soft damp cloth. If necessary use a weak soap solution.

Clean fabric upholstery with a vacuum cleaner and brush. Remove stains with an upholstery cleaner.

Clothing fabrics may not be colourfast. This could cause visible discolourations, especially on light-coloured upholstery. Removable stains and discolourations should be cleaned as soon as possible.

Clean seat belts with lukewarm water or interior cleaner.

#### Caution

Close Velcro fasteners as open Velcro fasteners on clothing could damage seat upholstery.

The same applies to clothing with sharp-edged objects, e.g. zips, belts or studded jeans.

### Plastic and rubber parts

Plastic and rubber parts can be cleaned with the same cleaner as used to clean the body. Use interior cleaner if necessary. Do not use any other agent. Avoid solvents and petrol in particular. Do not use high-pressure jet cleaners.

## Service and maintenance

<b>General information</b> .....	<b>204</b>
Service information .....	204
<b>Recommended fluids, lubricants and parts</b> .....	<b>205</b>
Recommended fluids and lubricants .....	205

## General information

### Service information

In order to ensure economical and safe vehicle operation and to maintain the value of your vehicle, it is of vital importance that all maintenance work is carried out at the proper intervals as specified.

The detailed, up-to-date service schedule for your vehicle is available at the workshop.

Service display ⇨ 79.

### European service intervals

Maintenance of your vehicle is required every 20,000 miles or after one year, whichever occurs first, unless otherwise indicated in the service display.

A shorter service interval can be valid for severe driving behaviour, e.g. for taxis and police vehicles.

The European service intervals are valid for the following countries:

Andorra, Austria, Belgium, Bosnia-Herzegovina, Bulgaria, Croatia, Cyprus, Czech Republic, Denmark, Estonia, Finland, France, Germany, Greece, Greenland, Hungary, Iceland, Ireland, Italy, Latvia, Liechtenstein, Lithuania, Luxembourg, Macedonia, Malta, Monaco, Montenegro, Netherlands, Norway, Poland, Portugal, Romania, San Marino, Serbia, Slovakia, Slovenia, Spain, Sweden, Switzerland, United Kingdom.

Service display ⇨ 79.

### International service intervals

Maintenance of your vehicle is required every 10,000 miles or after one year, whichever occurs first, unless otherwise indicated in the service display.

The international service intervals are valid for the countries which are not listed in the European service intervals.

Service display ⇨ 79.

## Confirmations

Confirmation of service is recorded in the Service and warranty booklet. The date and mileage is completed with the stamp and signature of the servicing workshop.

Make sure that the Service and warranty booklet is completed correctly as continuous proof of service is essential if any warranty or goodwill claims are to be met, and is also a benefit when selling the vehicle.

## Service interval with remaining engine oil life duration

The service interval is based on several parameters depending on usage.

The service display lets you know when to change the engine oil.

Service display ⇨ 79.

## Recommended fluids, lubricants and parts

### Recommended fluids and lubricants

Only use products that meet the recommended specifications.

#### Warning

Operating materials are hazardous and could be poisonous. Handle with care. Pay attention to information given on the containers.

### Engine oil

Engine oil is identified by its quality and its viscosity. Quality is more important than viscosity when selecting which engine oil to use. The oil quality ensures e.g. engine cleanliness, wear protection and oil aging control, whereas viscosity grade gives information on the oil's thickness over a temperature range.

Dexos is the newest engine oil quality that provides optimum protection for gasoline and diesel engines. If it is unavailable, engine oils of other listed qualities have to be used.

Recommendations for gasoline engines are also valid for Compressed Natural Gas (CNG), Liquefied Petroleum Gas (LPG) and Ethanol (E85) fuelled engines.

Select the appropriate engine oil based on its quality and on the minimum ambient temperature ⇨ 209.

### Topping up engine oil

Engine oils of different manufacturers and brands can be mixed as long as they comply with the required engine oil quality and viscosity.

Use of engine oil with only ACEA A1/B1 or only A5/B5 quality is prohibited, since it can cause long-term engine damage under certain operating conditions.

Select the appropriate engine oil based on its quality and on the minimum ambient temperature ⇨ 209.

### **Additional engine oil additives**

The use of additional engine oil additives could cause damage and invalidate the warranty.

### **Engine oil viscosity grades**

The SAE viscosity grade gives information of the thickness of the oil.

Multigrade oil is indicated by two figures, e.g. SAE 5W-30. The first figure, followed by a W, indicates the low temperature viscosity and the second figure the high temperature viscosity.

Select the appropriate viscosity grade depending on the minimum ambient temperature ⇨ 209.

All of the recommended viscosity grades are suitable for high ambient temperatures.

### **Coolant and antifreeze**

Use only organic acid type-long life coolant (LLC) antifreeze approved for the vehicle. Consult a workshop.

The system is factory filled with coolant designed for excellent corrosion protection and frost protection down to approx. -28 °C. In

northern countries with very low temperatures the factory filled coolant provides frost protection down to approx. -37 °C. This concentration should be maintained all year round.

The use of additional coolant additives that intend to give additional corrosion protection or seal against minor leaks can cause function problems. Liability for consequences resulting from the use of additional coolant additives will be rejected.

### **Brake and clutch fluid**

Over time, brake fluid absorbs moisture which will reduce braking effectiveness. The brake fluid should therefore be replaced at the specified interval.



## Technical data

<b>Vehicle identification</b> .....	<b>207</b>
Vehicle Identification Number ..	207
Identification plate .....	207
Engine identification .....	208
<b>Vehicle data</b> .....	<b>209</b>
Recommended fluids and lubricants .....	209
Engine data .....	212
Performance .....	213
Vehicle weight .....	214
Vehicle dimensions .....	215
Capacities .....	216
Tyre pressures .....	217

## Vehicle identification

### Vehicle Identification Number

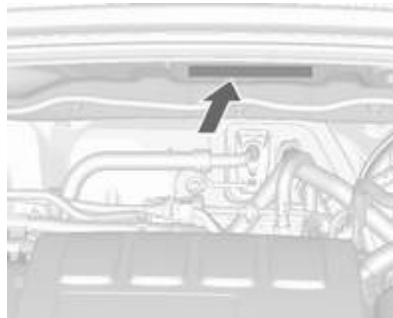

The Vehicle Identification Number is located in the engine compartment.

The Vehicle Identification Number may be embossed on the instrument panel, visible through the windscreen.

## Identification plate



The identification plate is located on the front left or right door frame.

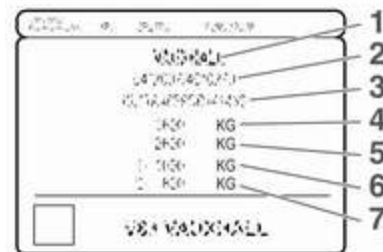

Information on identification label:

- 1 : manufacturer
- 2 : type approval number
- 3 : vehicle Identification Number
- 4 : permissible gross vehicle weight rating in kg
- 5 : permissible gross train weight in kg
- 6 : maximum permissible front axle load in kg
- 7 : maximum permissible rear axle load in kg

### Engine identification

The technical data tables show the engine identifier code. Engine data ⇨ 212.

To identify the respective engine, refer to the engine power in the EEC Certificate of Conformity provided with your vehicle or other national registration documents.

The Certificate of Conformity shows the engine identifier code, other national publications may show the engineering code. Check piston displacement and engine power to identify the respective engine.

## Vehicle data

### Recommended fluids and lubricants

#### European service schedule

#### Required engine oil quality

All European countries with European service interval ⇨ 204

Engine oil quality	Petrol engines (including CNG, LPG, E85)	Diesel engines
<b>dexos 1</b>	–	–
<b>dexos 2</b>	✓	✓

In case dexos quality is unavailable you may use max. one litre engine oil quality ACEA C3 once between each oil change.

#### Engine oil viscosity grades

All European countries with European service interval ⇨ 204

Ambient temperature	Petrol and diesel engines
down to -25 °C	SAE 5W-30 or SAE 5W-40
below -25 °C	SAE 0W-30 or SAE 0W-40

## International service schedule

## Required engine oil quality

## All countries with international service interval ⇨ 204

Engine oil quality	Petrol engines (including CNG, LPG, E85)	Diesel engines
<b>dexos 1</b> (if available)	✓	–
<b>dexos 2</b>	✓	✓

In case dexos quality is unavailable you may use the oil qualities listed below:

## All countries with international service interval ⇨ 204

Engine oil quality	Petrol engines (including CNG, LPG, E85)	Diesel engines
GM-LL-A-025	✓	–
GM-LL-B-025	–	✓

## All countries with international service interval ⇨ 204

Engine oil quality	Petrol engines (including CNG, LPG, E85)	Diesel engines
ACEA A3/B3	✓	–
ACEA A3/B4	✓	✓

---

**All countries with international service interval ⇨ 204**

---

ACEA C3	✓	✓
API SM	✓	-
API SN resource conserving	✓	-

---

**Engine oil viscosity grades**

---

**All countries with international service interval ⇨ 204**

---

Ambient temperature	Petrol and diesel engines
down to -25 °C	SAE 5W-30 or SAE 5W-40
below -25 °C	SAE 0W-30 or SAE 0W-40
down to -20 °C	SAE 10W-30 <sup>1)</sup> or SAE 10W-40 <sup>1)</sup>

---

1) Permitted, but usage of SAE 5W-30 or SAE 5W-40 with dexos quality is recommended.

## Engine data

	A14NET	B14NET	A16XER	A18XER	B16DTH 81 kW	B16DTH 100 kW
<b>Engine identifier code</b>						
<b>Sales designation</b>	1.4	1.4 LPG	1.6	1.8	1.6	1.6
<b>Engineering code</b>	A14NET	B14NET	A16XER	A18XER	B16DTH	B16DTH
Piston displacement [cm <sup>3</sup> ]	1364	1364	1598	1796	1598	1598
Engine power [kW]	103	103	85	103	81	100
at rpm	4900-6000	4900-6000	6200	6200	3500	3500-4000
Torque [Nm]	200	200	155	178	300	320
at rpm	1850-4900	1850-4900	4000	3800	1750-2000	2000-2250
Fuel type	Petrol	Liquid Gas/Petrol	Petrol	Petrol	Diesel	Diesel
Octane rating RON <sup>2)</sup>						
recommended	95	95	95	95		
possible	98	98	98	98		
possible	91	91	91	91		
Additional fuel type	–	Liquid gas (LPG)	–	–	–	–

2) A country specific label at the fuel filler flap can supersede the engine specific requirement.

## Performance

Engine	A14NET	B14NET LPG	A16XER	A18XER	B16DTH 100kW	B16DTH 81 kW
Maximum speed [mph]						
Manual transmission	120	120	106	112	118/116 <sup>3)</sup>	111
Automatic transmission	116	–	–	112	117	–

3) Vehicles with All-wheel drive system.

## Vehicle weight

### Kerb weight, basic model without any optional equipment

	Engine	Manual transmission	Automatic transmission
[kg]	A14NET	1394	1409
	B14NET LPG	1464	–
	A16XER	1355	–
	A18XER	1349	1446
	B16DTH 83 kW	1374	–
	B16DTH 100 kW	1374	1387
	B16DTH <sup>4)</sup> 100 kW	1429	–

4) Vehicles with All-wheel drive system.

Optional equipment and accessories increase the kerb weight.

Loading information ⇨ 69.



---

## Vehicle dimensions

Length [mm]	4278
Width without exterior mirrors [mm]	1764
Width with two exterior mirrors [mm]	2038
Height (without antenna) [mm]	1658
Length of load compartment floor [mm]	729
Length of load compartment with folded rear seats [mm]	1428
Load compartment width [mm]	915
Load compartment height [mm]	757
Wheelbase [mm]	2555
Turning circle diameter [m]	11.5

---

## Capacities

### Engine oil

Engine	A14NET	B14NET LPG	A16XER	A18XER	B16DTH
including Filter [l]	4.0	4.0	4.5	4.5	5.0
between MIN and MAX [l]	1.0	1.0	1.0	1.0	1.0

### Fuel tank

Engine	A14NET	B14NET LPG	A16XER	A18XER	B16DTH
Petrol/diesel, refilling quantity [l]	52	52	52	53	52
LPG, refilling quantity [l]	–	34	–	–	–

## Tyre pressures

Engine	Tyres	Comfort with up to 3 people		ECO with up to 3 people		With full load	
		front	rear	front	rear	front	rear
		[kPa/bar] ([psi])	[kPa/bar] ([psi])	[kPa/bar] ([psi])	[kPa/bar] ([psi])	[kPa/bar] ([psi])	[kPa/bar] ([psi])
A14NET, B14NET LPG, A16XER, A18XER	215/60 R17,  215/55 R18	220/2.2 (32)	220/2.2 (32)	270/2.7 (39)	280/2.8 (41)	270/2.7 (39)	300/3.0 (44)
	205/70 R16, 215/65 R16	200/2.0 (29)	200/2.0 (29)	270/2.7 (39)	280/2.8 (41)	270/2.7 (39)	300/3.0 (44)
	225/45 R19	240/2.4 (35)	240/2.4 (35)	270/2.7 (39)	280/2.8 (41)	270/2.7 (39)	280/2.8 (41)

## 218 Technical data

Engine	Tyres	Comfort with up to 3 people		ECO with up to 3 people		With full load	
		front	rear	front	rear	front	rear
		[kPa/bar] ([psi])	[kPa/bar] ([psi])	[kPa/bar] ([psi])	[kPa/bar] ([psi])	[kPa/bar] ([psi])	[kPa/bar] ([psi])
B16DTH	215/60R17,	240/2.4 (35)	240/2.4 (35)	270/2.7 (39)	280/2.8 (41)	270/2.7 (39)	300/3.0 (44)
	215/55 R18						
	205/70 R16, 215/65 R16	220/2.2 (32)	220/2.2 (32)	270/2.7 (39)	280/2.8 (41)	270/2.7 (39)	300/3.0 (44)
	225/45 R19	240/2.4 (35)	240/2.4 (35)	270/2.7 (39)	280/2.8 (41)	270/2.7 (39)	280/2.8 (41)
All	Temporary spare wheel 125/70 R16	420/4.2 (61)	420/4.2 (61)	–	–	420/4.2 (61)	420/4.2 (61)

## Customer information

<b>Customer information</b> .....	<b>219</b>
Declaration of conformity .....	219
Collision damage repair .....	221
Software acknowledgement ....	221
<b>Vehicle data recording and privacy</b> .....	<b>223</b>
Event data recorders .....	223
Radio Frequency Identification (RFID) .....	223

## Customer information

### Declaration of conformity

#### Transmission systems

This vehicle has systems that transmit and/or receive radio waves subject to Directive 1999/5/EC. These systems are in compliance with the essential requirements and other relevant provisions of Directive 1999/5/EC. Copies of the original Declarations of Conformity can be obtained on our website.



GM Korea

GM Korea Company  
249, E. Chungjeong-Ro, Bldg.  
Jeongjeong, Suwon, 463-714, Korea

**Declaration of Conformity**

pursuant to Directive 2006/42/EC

We hereby declare that the product:

**Product description :** Car Jack

**Type/Part No. :** 13590195

is in conformity with Directive 2006/42/EC.

Technical standards applied:

GMW14337 Standard Equipment Jack - Hardware Tests  
GMW15005 Standard Equipment Jack and Spare Tire, Vehicle Test

The person authorized to compile the technical file is:

Hans-Peter Metzger  
Adam Opel AG  
65423 Rüsselsheim / Germany

Incheon, Republic of Korea, 4 April 2014

Daehyuk An  
Engineering Group Manager Tire Wheel Systems  
GM Korea

## Collision damage repair

### Paint thickness

Due to production techniques, the thickness of the paint can vary between 50 and 400 µm.

Therefore, different paint thickness is no indicator for a collision damage repair.

## Software acknowledgement

Certain OnStar components include libcurl and unzip software and other third party software. Below are the notices and licenses associated with libcurl and unzip and for other third party software please see <http://www.lg.com/global/support/opensource/index>.

### libcurl

Copyright and permission notice

Copyright (c) 1996 - 2010, Daniel Stenberg, <daniel@haxx.se>.

All rights reserved.

Permission to use, copy, modify, and distribute this software for any purpose with or without fee is hereby granted, provided that the above copyright notice and this permission notice appear in all copies.

The software is provided "as is", without warranty of any kind, express or implied, including but not limited to the warranties of merchantability, fitness for a particular purpose and noninfringement of third party rights. In no event shall the authors or copyright holders be liable for any claim, damages or other liability, whether in an action of contract, tort or otherwise, arising from, out of or in connection with the software or the use or other dealings in the software.

Except as contained in this notice, the name of a copyright holder shall not be used in advertising or otherwise to promote the sale, use or other dealings in this Software without prior written authorization of the copyright holder.

### unzip

This is version 2005-Feb-10 of the Info-ZIP copyright and license. The definitive version of this document should be available at <ftp://ftp.info-zip.org/pub/infozip/license.html> indefinitely.

Copyright (c) 1990-2005 Info-ZIP. All rights reserved.

For the purposes of this copyright and license, "Info-ZIP" is defined as the following set of individuals:

Mark Adler, John Bush, Karl Davis, Harald Denker, Jean-Michel Dubois, Jean-loup Gailly, Hunter Goatley, Ed Gordon, Ian Gorman, Chris Herborth, Dirk Haase, Greg Hartwig, Robert Heath, Jonathan Hudson, Paul Kienitz, David Kirschbaum, Johnny Lee, Onno van der Linden, Igor Mandrichenko, Steve P. Miller, Sergio Monesi, Keith Owens, George Petrov, Greg Roelofs, Kai Uwe Rommel, Steve Salisbury, Dave Smith, Steven M. Schweda, Christian Spieler, Cosmin Truta, Antoine Verheijen, Paul von Behren, Rich Wales, Mike White.

This software is provided "as is," without warranty of any kind, express or implied. In no event shall Info-ZIP or its contributors be held liable for any direct, indirect, incidental, special or consequential damages arising out of the use of or inability to use this software.

Permission is granted to anyone to use this software for any purpose, including commercial applications, and to alter it and redistribute it freely, subject to the following restrictions:

1. Redistributions of source code must retain the above copyright notice, definition, disclaimer, and this list of conditions.
2. Redistributions in binary form (compiled executables) must reproduce the above copyright notice, definition, disclaimer, and this list of conditions in documentation and/or other materials provided with the distribution. The sole exception to this condition is redistribution of a standard UnZipSFX binary (including SFXWiz) as part of a self-extracting archive; that is

permitted without inclusion of this license, as long as the normal SFX banner has not been removed from the binary or disabled.

3. Altered versions--including, but not limited to, ports to new operating systems, existing ports with new graphical interfaces, and dynamic, shared, or static library versions--must be plainly marked as such and must not be misrepresented as being the original source. Such altered versions also must not be misrepresented as being Info-ZIP releases--including, but not limited to, labeling of the altered versions with the names "Info-ZIP" (or any variation thereof, including, but not limited to, different capitalizations), "Pocket UnZip," "WiZ" or "MacZip" without the explicit permission of Info-ZIP. Such altered versions are further prohibited from misrepresentative

use of the Zip-Bugs or Info-ZIP e-mail addresses or of the Info-ZIP URL(s).

4. Info-ZIP retains the right to use the names "Info-ZIP," "Zip," "UnZip," "UnZipSFX," "WiZ," "Pocket UnZip," "Pocket Zip," and "MacZip" for its own source and binary releases.



## Vehicle data recording and privacy

### Event data recorders

#### Data storage modules in the vehicle

A large number of electronic components of your vehicle contain data storage modules temporarily or permanently storing technical data about the condition of the vehicle, events and errors. In general, this technical information documents the condition of parts, modules, systems or the environment:

- Operating conditions of system components (e.g. filling levels)
- Status messages of the vehicle and its single components (e.g. number of wheel revolutions / rotational speed, deceleration, lateral acceleration)
- Dysfunctions and defects in important system components

- Vehicle reactions in particular driving situations (e.g. inflation of an airbag, activation of the stability regulation system)
- Environmental conditions (e.g. temperature)

These data are exclusively technical and help identifying and correcting errors as well as optimizing vehicle functions.

Motion profiles indicating travelled routes cannot be created with these data.

If services are used (e.g. repair works, service processes, warranty cases, quality assurance), employees of the service network (manufacturer included) are able to read out this technical information from the event and error data storage modules applying special diagnostic devices. If required, you will receive further information at these workshops. After an error has been corrected, the data are deleted from the error storage module or they are constantly overwritten.

When using the vehicle, situations may occur in which these technical data related to other information (accident report, damages on the vehicle, witness statements etc.) may be associated with a specific person - possibly, with the assistance of an expert.

Additional functions contractually agreed upon with the client (e.g. vehicle location in emergency cases) allow the transmission of particular vehicle data from the vehicle.

### Radio Frequency Identification (RFID)

RFID technology is used in some vehicles for functions such as tyre pressure monitoring and ignition system security. It is also used in connection with conveniences such as radio remote controls for door locking/unlocking and starting, and in-vehicle transmitters for garage door openers. RFID technology in Vauxhall vehicles does not use or record personal information or link with any other Vauxhall system containing personal information.

# Index

## A

Accessories and vehicle modifications .....	163
Adaptive forward lighting .....	87, 109
Adjustable air vents .....	121
Airbag and belt tensioners .....	83
Airbag deactivation .....	47, 83
Airbag label.....	42
Airbag system .....	42
Air conditioning regular operation .....	122
Air conditioning system .....	117
Air intake .....	122
Air vents.....	121
All-wheel drive .....	134
Antilock brake system .....	135
Antilock brake system (ABS) .....	84
Anti-theft alarm system .....	25
Anti-theft locking system .....	25
Appearance care.....	201
Automatic anti-dazzle .....	29
Automatic light control .....	107
Automatic locking .....	23
Automatic transmission .....	130
Autostop.....	126
Auxiliary heater.....	121

## B

Battery discharge protection .....	115
Battery voltage .....	95

Bicycle rack.....	56
Bonnet .....	164
Bonnet open.....	88
Brake and clutch fluid.....	205
Brake and clutch system .....	84
Brake assist .....	136
Brake fluid .....	168
Brakes .....	135, 168
Breakdown.....	199
Bulb replacement .....	171

## C

Capacities .....	216
Catalytic converter .....	130
Central locking system .....	21
Centre console storage .....	56
Centre high-mounted brake light .....	176
Changing tyre and wheel size ...	189
Charging system .....	84
Child locks .....	24
Child restraint installation locations .....	49
Child restraints.....	48
Child restraint systems .....	48
Climate control .....	15
Climate control systems.....	116
Clock .....	75
Code.....	93
Collision damage repair.....	221
Control indicators.....	80

Control of the vehicle .....	124
Controls.....	71
Convex shape .....	27
Coolant and antifreeze.....	205
Cruise control .....	88, 139
Cupholders .....	55
Curtain airbag system .....	46

**D**

Danger, Warnings and Cautions ...	4
Daytime running lights .....	109
Declaration of conformity.....	219
Delayed locking.....	23
Descent control system .....	85, 138
Diesel fuel system bleeding .....	170
Diesel particle filter.....	86, 129
Door open .....	88
Doors.....	24
Driver assistance systems.....	139
Driver Information Centre.....	88
Driving characteristics and towing tips .....	158
Driving hints.....	124

**E**

Electric adjustment .....	27
Electrical system.....	178
Electronic climate control system	118
Electronic driving programmes ..	132
Electronic Stability Control.....	137

Electronic Stability Control and Traction Control system.....	86
Electronic Stability Control off.....	85
End-of-life vehicle recovery .....	163
Engine compartment fuse box ...	178
Engine coolant .....	166
Engine coolant temperature gauge .....	79
Engine data .....	212
Engine exhaust .....	129
Engine identification.....	208
Engine oil .....	165, 205, 209
Engine oil pressure .....	86
Entry lighting .....	114
Event data recorders.....	223
Exit lighting .....	115
Exterior care .....	201
Exterior light .....	87
Exterior lighting .....	12, 106
Exterior mirrors.....	27

**F**

Fault .....	132
First aid kit .....	68
Fixed air vents .....	121
Flex-Fix system.....	56
Fog light .....	88
Fog lights .....	174
Folding mirrors .....	27
Forward collision alert.....	141

Front airbag system .....	45
Front fog lights .....	112
Front seats.....	35
Front turn signal lights .....	174
Fuel.....	151
Fuel consumption - CO <sub>2</sub> - Emissions .....	157
Fuel for diesel engines .....	151
Fuel for liquid gas operation.....	152
Fuel for petrol engines .....	151
Fuel gauge .....	78
Fuel selector .....	78
Fuses .....	178

**G**

Gauges.....	77
General information .....	158
Glovebox .....	55
Glove box lighting.....	114
Graphic-Info-Display, Colour- Info-Display .....	92

**H**

Halogen headlights .....	171
Hand brake.....	135
Hazard warning flashers .....	111
Headlight flash .....	108
Headlight range adjustment .....	108
Headlights when driving abroad	108
Head restraint adjustment .....	8
Head restraints .....	34

Heated mirrors .....	28
Heated rear window .....	31
Heated steering wheel .....	71
Heating .....	38
Heating and ventilation system .	116
High beam .....	87, 107
Hill start assist .....	136
Horn .....	13, 72

**I**

Identification plate .....	207
Ignition switch positions .....	125
Immobiliser .....	26, 87
Indicators.....	77
Information displays.....	88
Initial drive information.....	6
Instrument panel fuse box .....	180
Instrument panel illumination control .....	113
Instrument panel overview .....	10
Instrument panel storage.....	54
Interior care .....	203
Interior lighting.....	113
Interior lights .....	113, 177
Interior mirrors.....	28
Interruption of power supply .....	132
Introduction .....	3
ISOFIX child restraint systems ....	52

**J**

Jump starting .....	197
---------------------	-----

**K**

Key, memorised settings.....	21
Keys .....	19
Keys, locks.....	19

**L**

Lane departure warning.....	85, 150
Lashing eyes .....	68
Lighting features.....	114
Light switch .....	106
Load compartment .....	24, 65
Load compartment cover .....	67
Load compartment fuse box .....	181
Loading information .....	69
Low fuel .....	87

**M**

Malfunction indicator light .....	84
Manual anti-dazzle .....	28
Manual mode .....	132
Manual transmission .....	133
Manual windows .....	29
Memorised settings.....	21
Midlevel-Display.....	88
Mirror adjustment .....	8
Misted light covers .....	113

**N**

New vehicle running-in .....	124
Number plate light .....	177

**O**

Object detection systems.....	143
Odometer .....	77
Oil, engine.....	205, 209
OnStar.....	102
Operate pedal.....	84
Outside temperature .....	74
Overrun cut-off .....	126

**P**

Parking .....	17, 128
Parking assist .....	143
Parking brake .....	135
Particulate filter.....	129
Performance .....	213
Performing work .....	164
Pollen filter .....	122
Power outlets .....	76
Power steering.....	85
Power steering fluid.....	167
Power windows .....	30
Preheating .....	86
Puncture.....	193

**R**

Radio Frequency Identification (RFID).....	223
Radio remote control .....	20
Reading lights .....	114
Rear carrier system.....	56
Rear floor storage cover .....	67

Rear fog light .....	88, 112
Rear view camera .....	145
Rear window wiper/washer .....	74
Recommended fluids and lubricants .....	205, 209
Refuelling .....	154
Reversing lights .....	112
Ride control systems.....	136
Roof.....	32
Roof load.....	69
Roof rack .....	68

## S

Seat adjustment .....	6, 36
Seat belt .....	8
Seat belt reminder .....	83
Seat belts .....	39
Seat heating.....	38
Seat position .....	35
Selector lever .....	131
Service .....	122
Service display .....	79
Service information .....	204
Service vehicle soon .....	84
Side airbag system .....	45
Side turn signal lights .....	176
Software acknowledgement.....	221
Spare wheel .....	195
Speed limiter.....	140
Speedometer .....	77

Starting and operating.....	124
Starting off .....	16
Starting the engine .....	125
Steering.....	124
Steering wheel adjustment .....	9, 71
Steering wheel controls .....	71
Stop-start system.....	126
Storage compartments.....	54
Sunglasses storage .....	55
Sunroof .....	32
Sunvisor lights .....	114
Sun visors .....	31
Symbols .....	4

## T

Tachometer .....	78
Tail lights .....	175
Three-point seat belt .....	40
Tools .....	183
Top-tether fastening eyes .....	53
Tow bar.....	158
Towing.....	158, 199
Towing another vehicle .....	200
Towing equipment .....	159
Towing the vehicle .....	199
Traction Control system .....	136
Traction Control system off.....	86
Traffic sign assistant.....	147
Trailer towing .....	158
Transmission .....	16

Transmission display .....	130
Tread depth .....	188
Trip computer .....	96
Trip odometer .....	77
Turn and lane-change signals ...	112
Turn signal .....	83
Tyre chains .....	189
Tyre designations .....	184
Tyre pressure .....	184
Tyre pressure monitoring system.....	86, 185
Tyre pressures .....	217
Tyre repair kit .....	190

## U

Ultrasonic parking assist .....	85, 143
Underseat storage .....	56
Upholstery.....	203
Uplevel-Combi-Display.....	88
Uplevel-Display.....	88
Upshift.....	85
Using this manual .....	3

## V

Vehicle battery .....	168
Vehicle checks.....	164
Vehicle data.....	209
Vehicle data recording and privacy.....	223
Vehicle detected ahead.....	88
Vehicle dimensions .....	215

Vehicle Identification Number ....	207
Vehicle jack.....	183
Vehicle messages .....	93
Vehicle personalisation .....	99
Vehicle security.....	25
Vehicle specific data .....	3
Vehicle storage.....	163
Vehicle tools.....	183
Vehicle unlocking .....	6
Vehicle weight .....	214
Ventilation.....	116

## **W**

Warning chimes .....	95
Warning lights.....	77
Warning triangle .....	68
Washer and wiper systems .....	14
Washer fluid .....	167
Wheel changing .....	193
Wheel covers .....	189
Wheels and tyres .....	183
Windows.....	29
Windscreen.....	29
Windscreen wiper/washer .....	72
Winter tyres .....	183
Wiper blade replacement .....	170

## **X**

Xenon headlights .....	173
------------------------	-----

Copyright by General Motors UK Ltd.

The information contained in this publication is effective as of the date indicated below. General Motors UK Ltd. reserves the right to make changes to the technical specifications, features and design of the vehicles relative to the information contained in this publication, as well as changes to the publication itself.

Edition: January 2016, General Motors UK Ltd.

Printed on chlorine-free bleached paper.

KTA-2749/6-VX-en

01/2016

