

# GRANDLAND X

Owner's Manual



VAUXHALL



---

# Contents

Introduction .....	2
In brief .....	6
Keys, doors and windows .....	21
Seats, restraints .....	44
Storage .....	68
Instruments and controls .....	78
Lighting .....	112
Climate control .....	123
Driving and operating .....	133
Vehicle care .....	202
Service and maintenance .....	234
Technical data .....	238
Customer information .....	248
Index .....	256

## Introduction

Fuel	Designation	<input type="text"/>		
Engine oil	Grade	<input type="text"/>		
	Viscosity	<input type="text"/>		
Tyre pressure	Tyre size		Front	Rear
	Summer tyres	<input type="text"/>	<input type="text"/>	<input type="text"/>
	Winter tyres	<input type="text"/>	<input type="text"/>	<input type="text"/>
Weights	Gross vehicle weight rating	<input type="text"/>		
	- Kerb weight, basic model	<input type="text"/>		
	= Loading	<input type="text"/>		

## Vehicle specific data

Please enter your vehicle's data on the previous page to keep it easily accessible. This information is available in the sections "Service and maintenance" and "Technical data" as well as on the identification plate.

## Introduction

Your vehicle is a designed combination of advanced technology, safety, environmental friendliness and economy.

This Owner's Manual provides you with all the necessary information to enable you to drive your vehicle safely and efficiently.

Make sure your passengers are aware of the possible risk of accident and injury which may result from improper use of the vehicle.

You must always comply with the specific laws and regulations of the country that you are in. These laws may differ from the information in this Owner's Manual.

Disregarding the description given in this manual may affect your warranty.

When this Owner's Manual refers to a workshop visit, we recommend your Vauxhall Authorised Repairer.

All Vauxhall Authorised Repairers provide first-class service at reasonable prices. Experienced mechanics trained by Vauxhall work according to specific Vauxhall instructions.

The customer literature pack should always be kept ready to hand in the vehicle.

## Using this manual

- This manual describes all options and features available for this model. **Certain descriptions, including those for display and menu functions, may not apply to your vehicle due to model variant, country specifications, special equipment or accessories.**
- The "In brief" section will give you an initial overview.

- The table of contents at the beginning of this manual and within each section shows where the information is located.
- The index will enable you to search for specific information.
- This Owner's Manual depicts left-hand drive vehicles. Operation is similar for right-hand drive vehicles.
- The Owner's Manual uses the engine identifier code. The corresponding sales designation and engineering code can be found in the section "Technical data".
- Directional data, e.g. left or right, or front or back, always relate to the direction of travel.
- Displays may not support your specific language.
- Display messages and interior labelling are written in **bold** letters.

## Danger, Warnings and Cautions

### **Danger**

Text marked ** Danger** provides information on risk of fatal injury. Disregarding this information may endanger life.

### **Warning**

Text marked ** Warning** provides information on risk of accident or injury. Disregarding this information may lead to injury.

### **Caution**

Text marked **Caution** provides information on possible damage to the vehicle. Disregarding this information may lead to vehicle damage.

## Symbols

Page references are indicated with ⇨.  
⇨ means "see page".

Page references and index entries refer to the indented headings given in the section table of content.

Thank you for choosing a Vauxhall.

We wish you many hours of pleasurable driving.

**Your Vauxhall Team**



## In brief

### Initial drive information

#### Vehicle unlocking



Press  to unlock the doors and load compartment. Open the doors by pulling the handles.

Press  to unlock the tailgate only.

#### Tailgate

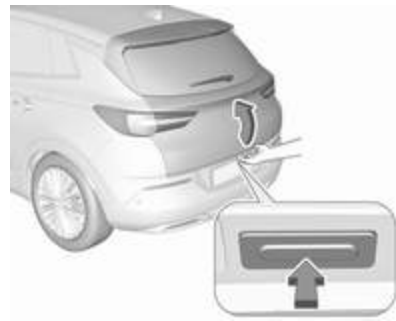

After unlocking, press the touchpad switch above the licence plate and open the tailgate.

Radio remote control ⇨ 22.

Central locking system ⇨ 24.

Electronic key system ⇨ 23.

Load compartment ⇨ 30.



## Seat adjustment

### Longitudinal adjustment



Pull handle, slide seat, release handle. Try to move the seat back and forth to ensure that the seat is locked in place.

Seat position ⇄ 45.

Manual seat adjustment ⇄ 46.

### Backrests inclination



Turn handwheel. Do not lean on backrest when adjusting.

Seat position ⇄ 45.

Manual seat adjustment ⇄ 46.

### Seat height

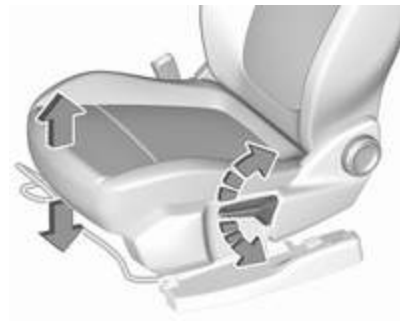

Lever pumping motion

up : seat higher

down : seat lower

Seat position ⇄ 45.

Manual seat adjustment ⇄ 46.

### Seat inclination



Press switch

top : front end higher  
bottom : front end lower

Seat position ⇨ 45.

Manual seat adjustment ⇨ 46.

### Head restraint adjustment



Press release button, adjust height, engage.

Head restraints ⇨ 44.

### Seat belt



Pull out the seat belt and fasten in belt buckle. The seat belt must not be twisted and must fit close against the body. The backrest must not be tilted back too far (maximum approx. 25°).

To unfasten belt, press red button on belt buckle.

Seat position ⇨ 45.

Seat belts ⇨ 52.

Airbag system ⇨ 55.

## Mirror adjustment

### Interior mirror



To adjust the mirror, move the mirror housing in the desired direction.

Manual anti-dazzle interior mirror  
↔ 39.

Automatic anti-dazzle interior mirror  
↔ 39.

### Exterior mirrors



Select the relevant exterior mirror by pushing the mirror button to the left or right. Adjust respective mirror by the four-way control.

Convex mirrors ↔ 38.

Electric adjustment ↔ 38.

Folding mirrors ↔ 38.

Heated mirrors ↔ 39.

## Steering wheel adjustment



Unlock lever, adjust steering wheel, then engage lever and ensure it is fully locked. Do not adjust steering wheel unless vehicle is stationary and steering wheel lock has been released.

Seat position ↔ 45.

Ignition positions ↔ 134.

## Instrument panel overview

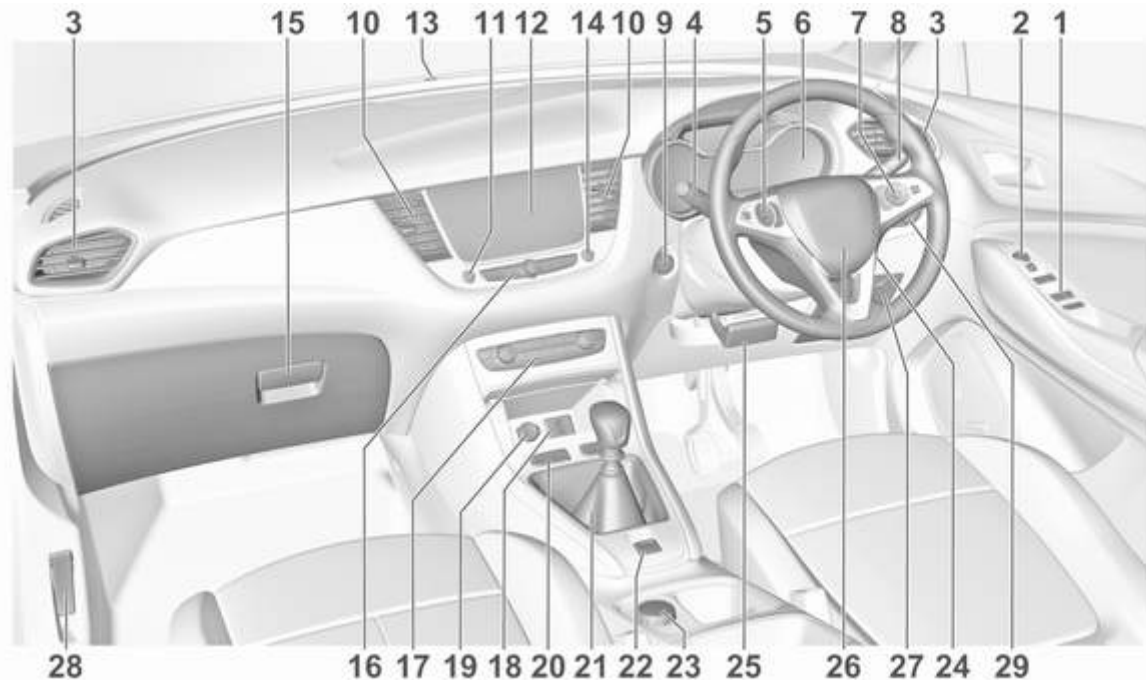

<p><b>1</b> Power windows ..... 40</p> <p><b>2</b> Exterior mirrors ..... 38</p> <p><b>3</b> Side air vents ..... 131</p> <p><b>4</b> Turn and lane-change signals, headlight flash, low/high beam, high beam assist ..... 118</p> <p style="padding-left: 20px;">Exit lighting ..... 122</p> <p style="padding-left: 20px;">Parking lights ..... 119</p> <p style="padding-left: 20px;">Buttons for Driver Information Centre ..... 99</p> <p><b>5</b> Cruise control ..... 158</p> <p style="padding-left: 20px;">Speed limiter ..... 160</p> <p style="padding-left: 20px;">Heated steering wheel ..... 79</p> <p><b>6</b> Instruments ..... 89</p> <p style="padding-left: 20px;">Driver Information Centre ..... 99</p> <p><b>7</b> Buttons for Driver Information Centre ..... 99</p> <p><b>8</b> Windscreen wiper and washer, rear wiper and washer ..... 80</p> <p><b>9</b> Power button ..... 135</p> <p><b>10</b> Centre air vents ..... 131</p>	<p><b>11</b> Hazard warning flashers .... 118</p> <p><b>12</b> Info-Display ..... 101</p> <p><b>13</b> Anti-theft alarm system status LED ..... 35</p> <p><b>14</b> Central locking system ..... 24</p> <p><b>15</b> Glovebox ..... 68</p> <p><b>16</b> Controls for Info-Display operation ..... 101</p> <p><b>17</b> Climate control system ..... 124</p> <p><b>18</b> USB charging port ..... 84</p> <p><b>19</b> Power outlet ..... 84</p> <p><b>20</b> Parking assist/Advanced parking assist ..... 174</p> <p style="padding-left: 20px;">Lane departure warning ..... 188</p> <p style="padding-left: 20px;">Eco button for stop-start system ..... 139</p> <p style="padding-left: 20px;">Electronic Stability Control and Traction Control ..... 153</p> <p style="padding-left: 20px;">Sport mode ..... 157</p> <p><b>21</b> Manual transmission ..... 149</p> <p style="padding-left: 20px;">Automatic transmission ..... 146</p> <p><b>22</b> Electric parking brake ..... 151</p> <p><b>23</b> Selective ride control ..... 155</p>	<p><b>24</b> Ignition switch ..... 134</p> <p><b>25</b> Steering wheel adjustment . . 79</p> <p><b>26</b> Horn ..... 80</p> <p><b>27</b> Storage ..... 68</p> <p><b>28</b> Bonnet release lever ..... 204</p> <p><b>29</b> Light switch ..... 112</p> <p style="padding-left: 20px;">Headlight range adjustment ..... 114</p> <p style="padding-left: 20px;">Front/rear fog lights ..... 119</p> <p style="padding-left: 20px;">Instrument illumination ..... 120</p>
--	--	---

## Exterior lighting



**AUTO** : automatic light control switches automatically between daytime running light and headlight

☞☞ : sidelights

☞D : headlights

Automatic light control ⇨ 112.

### Fog lights

Press button in light switch:

☞D : front fog lights

☞R : rear fog light

## Headlight flash, high beam and low beam



headlight flash : pull lever

high beam : push lever

low beam : push or pull lever

High beam ⇨ 113.

High beam assist ⇨ 113

Headlight flash ⇨ 114.

LED headlights ⇨ 115

## Turn and lane-change signals



lever up : right turn signal

lever down : left turn signal

Turn and lane-change signals ⇨ 118.

Parking lights ⇨ 119.

## Hazard warning flashers



Operated by pressing .

Hazard warning flashers ⇨ 118.

## Horn



Press .

## Washer and wiper systems

### Windscreen wiper



- HI** : fast
- LO** : slow
- INT** : interval wiping
- or
- AUTO** : automatic wiping with rain sensor
- OFF** : off

For single wipe when the wiper is off, press lever down to position **1x**.

Windscreen wiper ⇨ 80.

### Windscreen washer



Pull lever.

Windscreen washer system ↗ 80.

Washer fluid ↗ 207.

Wiper blade replacement ↗ 209.

### Rear window wiper



Turn outer cap to activate the rear window wiper:

**OFF** : off

**INT** : intermittent operation

**ON** : continuous operation

### Rear window washer



Push lever.

Washer fluid is sprayed on the rear window and the wiper wipes a few times.

Rear window wiper/washer ↗ 82.



## Climate control

### Heated rear window

Heating and ventilation system, air conditioning system



The heating is operated by pressing  REAR.

### Electronic climate control system



The heating is operated by pressing .

Heated rear window ⇨ 41.

### Heated exterior mirrors





Pressing  also activates the heated exterior mirrors.

Heated exterior mirrors ⇨ 39.

### Demisting and defrosting the windows

Heating and ventilation system, air conditioning system



- Press : the air distribution is directed towards the windscreen.
- Set temperature controller  to warmest level.
- Switch on air conditioning **A/C**, if required.
- Set fan speed  to highest level.
- Switch on heated rear window .

- Switch on heated windscreen .
- Open side air vents as required and direct them towards the door windows.





Heating and ventilation system  
⇨ 123.

Air conditioning system ⇨ 124.

Heated windscreen ⇨ 42.

### Electronic climate control system



- Press . The LED in the button illuminates to indicate activation.
- Temperature and air distribution are set automatically and the fan runs at high speed.
- Switch on air conditioning by pressing **A/C**, if required.
- Switch on heated rear window .
- Switch on heated windscreen .
- To return to previous mode, press  again. To return to automatic mode, press **AUTO**.

Electronic climate control system  
⇨ 126.

## Transmission

### Manual transmission



To engage reverse on 6-speed transmission, depress the clutch pedal, pull the ring under the selector lever and move the selector lever quite to the left and front.

Manual transmission ⇨ 149.

### Automatic transmission



**P** : park position  
**R** : reverse  
**N** : neutral mode  
**D** : automatic mode  
**M** : manual mode  
**+** : upshift  
**-** : downshift

Automatic transmission ⇨ 146.

## Starting off

### Check before starting off

- tyre pressure and condition  
⇨ 217, ⇨ 247
- Engine oil level and fluid levels  
⇨ 205.
- All windows, mirrors, exterior lighting and number plates are free from dirt, snow and ice and are operational.
- Proper position of mirrors, seats, and seat belts ⇨ 38, ⇨ 45, ⇨ 53.
- Brake function at low speed, particularly if the brakes are wet.

## Starting the engine

### Ignition switch

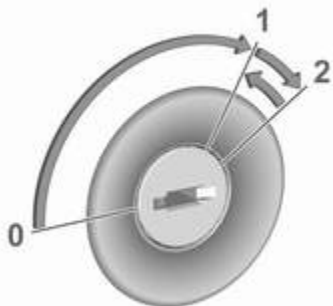

- Turn key to position **1**.
- Move the steering wheel slightly to release the steering wheel lock.
- Manual transmission: operate clutch and brake pedal.  
Automatic transmission: operate brake pedal and move selector lever to **P** or **N**.
- Do not operate accelerator pedal.
- Turn key to position **2** and release after engine has been started.

Diesel engine starts after control indicator  for preheating extinguishes.

Starting the engine ⇨ 137.

### Start power button



Manual transmission: operate clutch and brake pedal.

Automatic transmission: operate brake pedal and move selector lever to **P** or **N**.

Do not operate accelerator pedal.

Press and release **Start/Stop** button.  
Diesel engine starts after control indicator  for preheating extinguishes.

## Stop-start system



If the vehicle is at a low speed or at a standstill and certain conditions are fulfilled, an Autostop is activated.

An Autostop is indicated by control indicator (A).

Manual transmission: to restart the engine, depress the clutch pedal again. Control indicator (A) extinguishes.

Automatic transmission: to restart the engine, release the brake pedal. Control indicator (A) extinguishes.

Stop-start system ↗ 139.

## Parking

### ⚠ Warning

- Do not park the vehicle on an easily ignitable surface. The high temperature of the exhaust system could ignite the surface.
- Always apply the parking brake. Activate the manual parking brake without pressing the release button. Apply as firmly as possible on a downhill slope or uphill slope. Depress brake pedal at the same time to reduce operating force.
- Switch off the engine.
- If the vehicle is on a level surface or uphill slope, engage first gear or set the selector lever to position **P** before removing the ignition key or switching off ignition on vehicles with power button. On an uphill slope, turn the front wheels away from the kerb.

If the vehicle is on a downhill slope, engage reverse gear or set the selector lever to position **P** before removing the ignition key or switching off ignition on vehicles with power button. Turn the front wheels towards the kerb.

- Close the windows.
- Remove the ignition key from the ignition switch or switch off ignition on vehicles with power button. Turn the steering wheel until the steering wheel lock is felt to engage.
- Lock the vehicle with  on the radio remote control. Activate the anti-theft alarm system ↗ 35.
- The engine cooling fans may run after the engine has been switched off ↗ 204.

**Caution**

After running at high engine speeds or with high engine loads, operate the engine briefly at a low load or run in neutral for approx. 30 seconds before switching off, in order to protect the turbocharger.

Keys, locks ⇨ 21, Laying-up the vehicle for a long period of time ⇨ 203.

## Keys, doors and windows

<b>Keys, locks</b> .....	<b>21</b>
Keys .....	21
Radio remote control .....	22
Electronic key system .....	23
Central locking system .....	24
Automatic locking .....	28
Child locks .....	29
<b>Doors</b> .....	<b>30</b>
Load compartment .....	30
<b>Vehicle security</b> .....	<b>35</b>
Anti-theft locking system .....	35
Anti-theft alarm system .....	35
Immobiliser .....	37
<b>Exterior mirrors</b> .....	<b>38</b>
Convex shape .....	38
Electric adjustment .....	38
Folding mirrors .....	38
Heated mirrors .....	39
<b>Interior mirrors</b> .....	<b>39</b>
Manual anti-dazzle .....	39
Automatic anti-dazzle .....	39
<b>Windows</b> .....	<b>40</b>
Windscreen .....	40

Power windows .....	40
Heated rear window .....	41
Heated windscreen .....	42
Sun visors .....	42
Roller blinds .....	42
<b>Roof</b> .....	<b>43</b>
Glass panel .....	43

## Keys, locks

### Keys

<b>Caution</b>
Do not attach heavy or bulky items to the ignition key.

### Replacement keys

The key number is specified on a detachable tag.

The key number must be quoted when ordering replacement keys as it is a component of the immobiliser system.

Locks ⇨ 231, Central locking ⇨ 24, Starting the engine ⇨ 137.

Radio remote control ⇨ 22.

Electronic key ⇨ 23.

The code number of the adapter for the locking wheel nuts is specified on a card. It must be quoted when ordering a replacement adapter.

Wheel changing ⇨ 224.

### Key with foldaway key section



Press button to extend. To fold the key, first press the button.

### Lock cylinders

Designed to free-wheel if they are forcefully rotated without the correct key or if the correct key is not fully inserted. To reset, turn cylinder with the correct key until its slot is vertical, remove key then re-insert it. If the cylinder still free-wheels, turn the key through 180° and repeat operation.

### Radio remote control



Enables operation of the following functions via the use of the remote control buttons:

- central locking system ⇨ 24
- anti-theft locking system ⇨ 35
- anti-theft alarm system ⇨ 35
- tailgate unlocking and opening
- power windows ⇨ 40
- mirrors folding

The remote control has a range of up to 100 metres, but may also be much less due to external influences. The hazard warning flashers confirm operation.

Handle with care, protect from moisture and high temperatures and avoid unnecessary operation.

### Replacing battery in radio remote control

Replace the battery as soon as the range reduces.



Batteries do not belong in household waste. They must be disposed of at an appropriate recycling collection point.





1. Remove the back cover from the remote control.
2. Extract the flat battery from its location.
3. Replace battery with a battery of the same type. Pay attention to the installation position.
4. Clip the back cover in place.

### Fault

If the central locking system cannot be operated with the radio remote control, the cause may be one of the following:

- Fault in radio remote control.
- Electronic key is out of reception range.
- The battery voltage is too low.
- Overload of the central locking system by operating at frequent intervals, the power supply is interrupted for a short time.
- Interference from higher-power radio waves from other sources.

Manual unlocking ⇨ 24.

### Electronic key system



Enables a keyless operation of the following functions:

- central locking system ⇨ 24
- power tailgate ⇨ 30
- ignition switching on and starting the engine ⇨ 137

The electronic key simply needs to be on the driver's person.

Additionally, the electronic key includes the functionality of the radio remote control ⇨ 22.

Handle with care, protect from moisture and high temperatures and avoid unnecessary operation.

## Replacing battery in electronic key

Replace the battery as soon as the system no longer operates properly or the range is reduced. The need for battery replacement is indicated by a message in the Driver Information Centre ⇨ 103.



Batteries do not belong in household waste. They must be disposed of at an appropriate recycling collection point.



1. Remove the cover.
2. Extract the flat battery from its location.
3. Replace battery with a battery of the same type. Pay attention to the installation position.
4. Clip the cover in place.

### Fault

If the central locking cannot be operated or the engine cannot be started, the cause may be one of the following:

- Fault in electronic key.
- Electronic key is out of reception range.

- The battery voltage is too low.
- Overload of the central locking system by operating at frequent intervals, the power supply is interrupted for a short time.
- Interference from higher-power radio waves from other sources.

To rectify the cause of the fault, change the position of the electronic key.

Manual unlocking ⇨ 24.

## Central locking system

Unlocks and locks doors, load compartment and fuel filler flap.

A pull on an interior door handle unlocks the respective door. Pulling the handle once more opens the door.

### Notice

In the event of an accident in which airbags or belt pretensioners are deployed, the vehicle is automatically unlocked.

### Notice

A short time after unlocking with the remote control the doors are locked automatically if no door has been

opened. A precondition is that the setting is activated in the vehicle personalisation ↗ 104.



## Remote control operation

### Unlocking



Press .

Unlocking mode can be set in the vehicle personalisation menu in the Info-Display. Two settings are selectable:

- All doors, load compartment and fuel filler flap will be unlocked by pressing  once.
- Only the driver's door, load compartment and fuel filler flap will be unlocked by pressing  once. To unlock all doors, press  twice.

Select the relevant setting in the Vehicle personalisation.

Vehicle personalisation ↗ 104.

### Unlocking the tailgate

Press  longer to unlock the tailgate only.

Unlocking and opening the tailgate ↗ 30.

### Locking

Close doors, load compartment and fuel filler flap.



Press .

If the driver's door is not closed properly, the central locking system will not work.

### Confirmation

Operation of the central locking system is confirmed by the hazard warning flashers. A precondition is that the setting is activated in the vehicle personalisation ↗ 104.

## Electronic key system operation



The electronic key must be outside the vehicle, within a range of approx. one metre of the relevant door side.

## Unlocking



Pass your hand behind the door handle of one of the front doors to unlock the vehicle or press the tailgate opening control.

Keep the hand behind the door handle or keep the tailgate opening control pressed to open the windows.

Unlocking mode can be set in the vehicle personalisation menu in the Info-Display. Two settings are selectable:

- Only the driver's door will be unlocked by passing your hand behind the driver's door handle.

- All doors, load compartment and fuel filler flap will be unlocked by passing your hand behind the passenger's door handle or by pressing the tailgate opening control.
- Only the tailgate will be unlocked by pressing the tailgate touchpad.

Vehicle personalisation ↻ 104

## Locking



Press with a finger or thumb on one of the door handles (at the markings) or press the tailgate touchpad.

All doors, load compartment and fuel filler flap will be locked.

The system locks if any door has been opened and all doors are now closed.

If the driver's door is not closed properly, the electronic key remains in the vehicle or the ignition is not off, locking will not be permitted and a warning chime sounds.

If there have been two or more electronic keys in the vehicle and the ignition was on once, the doors will be locked even if just one electronic key is taken out of the vehicle.

### Unlocking and opening the tailgate

The tailgate can be unlocked and opened handsfree by pushing the touchpad switch under the tailgate moulding when the electronic key is in range. The doors remain locked. Load compartment ↻ 30.

### Operation with buttons on the electronic key



The central locking system can also be operated with the buttons on the electronic key.

Press  to unlock.

Press  to lock.

Press  longer to unlock and open only the power tailgate.

Remote control operation ↻ 24.

### Confirmation

Operation of central locking system is confirmed by the hazard warning flashers. A precondition is that the setting is activated in the vehicle personalisation ↻ 104.

### Central locking buttons

Locks or unlocks all doors, the load compartment and fuel filler flap from the passenger compartment via a switch in the driver's door panel.



Press  to lock. The LED in the button illuminates.

Press  again to unlock. The LED in the button extinguishes.

### Operation with the key in case of a central locking system fault

In case of a fault, e.g. vehicle battery or remote control/electronic key battery is discharged, the driver's door can be locked or unlocked with the mechanical key.

#### Manual unlocking

Electronic key: press and hold the latch to extract the integral key.



Manually unlock the driver's door by inserting and turning the key in the lock cylinder.

The other doors can be opened by pulling the interior handle. The load compartment and fuel filler flap will possibly not be unlocked.

By switching on the ignition, the anti-theft locking system is deactivated.

#### Manual locking



Manually lock the driver's door by inserting and turning the key in the lock cylinder.



To lock the other doors, remove the black cover by using a key.

Insert key carefully and move to the inner side of the door without turning the key.

Remove key and attach black cover.

The fuel filler flap and tailgate are possibly not locked.

### Automatic locking

#### Automatic locking after driving off

This system allows automatic simultaneous locking of the doors and boot as soon as the speed of the vehicle exceeds 10 km/h.

If one of the doors or the load compartment is open, the automatic central locking does not take place. This is signalled by the sound of the locks rebounding, accompanied by illumination of  in the instrument panel, an audible signal and the display of an alert message.



You can activate or deactivate this function permanently. With the ignition on, press  until an audible signal starts and a corresponding message is displayed.

The state of the system stays in memory when switching off the ignition.

### Automatic relock after unlocking

This feature automatically locks all doors, load compartment and fuel filler flap a short time after unlocking with the remote control or electronic key, provided no door has been opened.

### Child locks

#### Warning

Use the child locks whenever children are occupying the rear seats.

### Child locks, mechanical



Turn the red child lock in the rear door to the horizontal position by using a key. The door cannot be opened from the inside.

To deactivate, turn the child lock to the vertical position.

### Child locks, electric



Remotely operated system to prevent opening of the rear doors using their interior controls and use of the rear electric windows. The control is located in the centre console in front of the selector lever.

#### Switching on

Press . The indicator lamp in the button comes on, accompanied by a confirmation message. This indicator lamp remains on until the child lock is switched off.

#### Switching off

Press  again. The indicator lamp on button goes off, accompanied by a confirmation message. This indicator lamp remains on while child lock is switched on.

## Doors

### Load compartment

#### Tailgate

##### Opening

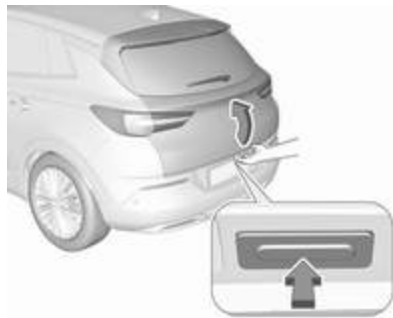

After unlocking, press the touchpad switch under the tailgate moulding and open the tailgate.



## Closing



Use the interior handle.

Do not push the touchpad switch whilst closing as this will unlock the tailgate again.

Central locking system ↗ 24.



## Power tailgate

### ⚠ Warning

Take care when operating the power tailgate. Risk of injury, particularly to children.

Keep a close watch on the movable tailgate when operating. Ensure that nothing becomes trapped during operating and no one is standing within the moving area.

The power tailgate can be operated by:

- Pressing  longer on the electronic key.
- Handsfree operation with motion sensor below the rear bumper.
- The touchpad switch under the exterior tailgate moulding and  in the open tailgate.

On vehicles with automatic transmission, the tailgate can only be operated when the vehicle is stationary and automatic transmission in **P**.

The turn signal lights flash and a chime sounds when the power tailgate is operating.

### Notice

Operating the power tailgate does not operate the central locking system. To open the tailgate with the

button on the electronic key, or with the touchpad switch under the tailgate moulding or via handsfree operation, it is not necessary to unlock the vehicle. A precondition is that the electronic key is outside the vehicle, within a range of approx. one metre of the tailgate.

Do not leave the electronic key in the load compartment.

Lock the vehicle after closing if it was unlocked previously.

Central locking system ↗ 24.

## Operation with the electronic key



Press  longer to open or close the tailgate.

### Handsfree operation with motion sensor below the rear bumper



To open or close the tailgate move the foot below the rear bumper back and forth in the area below the license plate (see illustration). The key must be within a range of one meter. If equipped with parking assist, the area is recognisable below the shown sensor. Do not hold the foot longer or move too slow below the bumper. The electronic key must be outside the vehicle, within a range of approx. one metre of the tailgate.

Activation or deactivation of handsfree operation can be set in the menu **Settings**, **Vehicle** in the Info-Display.

Info-Display  101.

Vehicle personalisation  104.

### Danger

Do not touch any vehicle parts below the vehicle during handsfree operation. There is a risk of injury from hot engine parts.

### Automatic locking after handsfree operation



Press button  in the open tailgate, the whole vehicle will be locked after handsfree closing of the tailgate.

### Operation with the touchpad switch under the exterior tailgate moulding

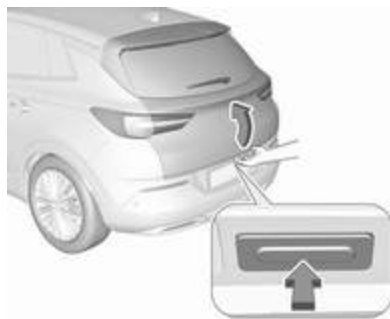



To open the tailgate, press the touchpad switch under the tailgate moulding until the tailgate starts to move. If the vehicle is locked, the electronic key must be outside the vehicle, within a range of approx. one metre of the tailgate.



To close, press  in the open tailgate until the tailgate starts to move.

### Stop or change direction of movement

Stop movement of the tailgate immediately:

- press  longer on the electronic key, or
- press the touchpad switch under the exterior tailgate moulding, or
- press  on the open tailgate.

Pressing one of the switches again will reverse the direction of movement.

### Adjust reduced opening height

1. Open power tailgate with any operation switch.
2. Stop movement at the desired height by pressing . If required, manually move the stopped tailgate to the desired position.



3. Press and hold the button  on the inside of the open tailgate for three seconds.

### Notice

Adjusting opening height should be programmed at ground level.

A chime sound indicates the new setting and the turn signal lights will flash. The reduced height can only be set at an opening angle of above 30°.

To delete reduced height position, open tailgate in half position and press  for three seconds

The tailgate can only be held open if a minimum height is exceeded (minimum opening angle from 30°). The opening height cannot be programmed below that height.

### Safety function

If the power tailgate encounters an obstacle during opening or closing, the direction of movement will automatically be reversed slightly. Multiple obstacles in one power cycle will deactivate the function. In this case, close or open the tailgate manually.

The power tailgate has pinch sensors on the side edges. If the sensors detect obstacles between tailgate and chassis, the tailgate will open, until it is activated again or closed manually.

The safety function is indicated by a warning chime.

Remove all obstacles before resuming normal power operation.

If the vehicle is equipped with factory-fitted towing equipment and a trailer is electrically connected, the power tailgate can only be opened with the touchpad switch or closed with  in the open tailgate. Ensure that there are no obstacles in the moving area.

### Overload

If the power tailgate is repeatedly operated at short intervals, the function is disabled for some time. Move tailgate manually into end position to reset the system.

### Initialising power tailgate

If the power tailgate cannot be operated automatically (e.g. after disconnecting the vehicle battery), a warning message is displayed in the Driver Information Centre.

Activate electronics as follows:

1. Open tailgate manually.
2. Close tailgate manually.
3. Switch on ignition.

Seek the assistance of a workshop if the problem is not solved.

### General hints for operating tailgate

#### Danger

Do not drive with the tailgate open or ajar, e.g. when transporting bulky objects, since toxic exhaust gases, which cannot be seen or smelled, could enter the vehicle. This can cause unconsciousness and even death.

#### Caution

Before opening the tailgate, check overhead obstructions, e.g. a garage door, to avoid damage to the tailgate. Always check the moving area above and behind the tailgate.

#### Notice

The installation of certain heavy accessories onto the tailgate may affect its ability to remain open.

#### Notice

The operation of the power tailgate is disabled under low vehicle battery conditions. In this case, the tailgate may not even be manually operable.

#### Notice

With the power tailgate disabled and all doors unlocked, the tailgate can only be operated manually. In this event, manually closing the tailgate requires significantly greater force.

#### Notice

At low outside temperatures the tailgate may not open fully by itself. In this case lift the tailgate manually to its normal end position.

## Vehicle security

### Anti-theft locking system

#### ⚠ Warning

Do not use the system if there are people in the vehicle! The doors cannot be unlocked from the inside.

The system deadlocks all the doors. All doors must be closed otherwise the system cannot be activated.

Unlocking the vehicle disables the mechanical anti-theft locking system. This is not possible with the central locking button.

### Activating



Press Ⓛ on the radio remote control twice within five seconds.

### Anti-theft alarm system

The anti-theft alarm system is combined with the central locking system.

It monitors:

- doors, tailgate, bonnet
- passenger compartment including adjoining load compartment

- vehicle inclination, e.g. if it is raised
- ignition

### Activation

All doors must be closed and the electronic key of the electronic key system must not remain in the vehicle. Otherwise the system cannot be activated.

- Radio remote control: self-activated 30 seconds after locking the vehicle by pressing Ⓛ once.
- Electronic key system: self-activated 30 seconds after locking the vehicle by pressing with a finger or thumb on one of the front door handles at the markings.



- Radio remote control or electronic key: directly by pressing  twice within five seconds.
- Electronic key system with passive locking enabled: briefly activated after passive locking occurs.



#### Notice

Changes to the vehicle interior such as the use of seat covers and open windows, could impair the function of passenger compartment monitoring.

#### Activation without monitoring of passenger compartment and vehicle inclination



Switch off the monitoring of passenger compartment and vehicle inclination when animals are being left in the vehicle, because of high volume ultrasonic signals or movements triggering the alarm. Also switch off when the vehicle is on a ferry or train.

1. Close tailgate, bonnet, windows.
2. Press . LED in the button  illuminates for a maximum of ten minutes.

3. Close doors.
4. Activate the anti-theft alarm system.

Status message is displayed in the Driver Information Centre.

#### Indication

LED in the central locking button flashes if the anti-theft alarm system is activated.

Seek the assistance of a workshop in the event of faults.

#### Deactivation

Radio remote control: Unlocking the vehicle by pressing  deactivates the anti-theft alarm system.



Electronic key system: Unlocking the vehicle by pressing on one of the front door handles at the markings deactivates the anti-theft alarm system.

The electronic key must be outside the vehicle, within a range of approx. one metre of the relevant door side.

The system is not deactivated by unlocking the driver's door with the key or with the central locking button in the passenger compartment.

## Alarm

When triggered, the alarm horn sounds and the hazard warning lights flash simultaneously. The number and duration of alarm signals are stipulated by legislation.

The anti-theft alarm system can be deactivated by pressing , by pressing the switch on the door handle with electronic key system or switching on the ignition.

The anti-theft alarm system can be deactivated by pressing , by pressing on one of the front door handles at the markings with electronic key system or switching on the ignition.

A triggered alarm, which has not been interrupted by the driver, will be indicated by the hazard warning lights. They will flash quickly three times the next time the vehicle is unlocked with the radio remote control. Additionally a warning message is displayed in the Driver Information Centre after switching on the ignition.

Vehicle messages ⇨ 103.

If the vehicle's battery is to be disconnected (e.g. for maintenance work), the alarm siren must be deactivated as follows: switch the ignition on then off, then disconnect the vehicle's battery within 15 seconds.

## Immobiliser

The system is part of the ignition switch and checks whether the vehicle is allowed to be started with the key being used.

The immobiliser is activated automatically after the key has been removed from the ignition switch.

### Notice

Radio Frequency Identification (RFID) tags may cause interference with the key. Do not have it placed near the key when starting the vehicle.

### Notice

The immobiliser does not lock the doors. You should always lock the vehicle after leaving it and switch on the anti-theft alarm system ⇨ 24, ⇨ 35.

## Exterior mirrors

### Convex shape

The convex exterior mirror on the driver's side contains an aspherical area and reduces blind spots. The shape of the mirror makes objects appear smaller, which will affect the ability to estimate distances.

Side blind spot alert ⇨ 182.

### Electric adjustment

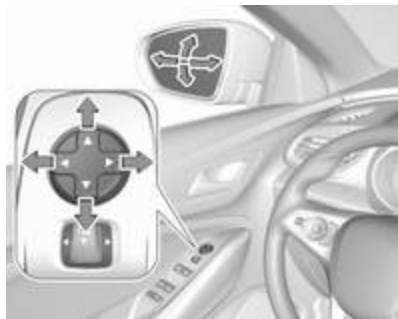

Select the relevant exterior mirror by pushing the mirror button to the left or right.

Then swivel the control to adjust the mirror.

### Folding mirrors



For pedestrian safety, the exterior mirrors will swing out of their normal mounting position if they are struck with sufficient force. Reposition the mirror by applying slight pressure to the mirror housing.

### Electric folding



Pull mirror button rearwards. Both exterior mirrors will fold.

Pull mirror button rearwards again to return both exterior mirrors to their original position.

If an electrically folded mirror is manually extended, pulling mirror button rearwards will only electrically extend the other mirror.



## Heated mirrors



Operated by pressing  .

Heating works with the engine running and is switched off automatically after a short time.

Heated rear window  41.

## Interior mirrors

### Manual anti-dazzle



To reduce dazzle, adjust the lever on the underside of the mirror housing.

### Automatic anti-dazzle



Dazzle from following vehicles at night is automatically reduced.

## Windows

### Windscreen

#### Windscreen stickers

Do not attach stickers such as toll road stickers or similar on the windscreen in the area of the interior mirror. Otherwise the detection zone of the sensor and the view area of the camera in the mirror housing could be restricted.

#### Windscreen replacement

##### Caution

If the vehicle has a front-looking camera sensor for the driver assistance systems, it is very important that any windscreen replacement is performed accurately according to Vauxhall specifications. Otherwise, these systems may not work properly and there is a risk of unexpected behaviour and/or messages from these systems.

### Power windows

#### ⚠ Warning

Take care when operating the power windows. Risk of injury, particularly to children.

If there are children on the rear seats, switch on the child safety system for the power windows.

Keep a close watch on the windows when closing them. Ensure that nothing becomes trapped in them as they move.

Switch on ignition to operate power windows. .



Operate the switch for the respective window by pushing to open or pulling to close.

Pushing or pulling gently to the first detent: window moves up or down as long as the switch is operated.

Pushing or pulling firmly to the second detent then releasing: window moves up or down automatically with safety function enabled. To stop movement, operate the switch once more in the same direction.

#### Safety function



If the window glass encounters resistance above the middle of the window during automatic closing, it is immediately stopped and opened again.

#### Override safety function

In the event of closing difficulties due to frost or the like, switch on the ignition, then pull the switch to the first detent and hold. The window moves up without safety function enabled. To stop movement, release the switch.

## Child safety system for rear windows



Press  to deactivate rear door power windows; the LED illuminates. To activate, press  again.

## Operating windows from outside

The windows can be operated remotely from outside the vehicle.

Press and hold  to close windows.

Release button to stop window movement.

If the windows are fully closed, the hazard warning lights will flash twice.

## Overload

If the windows are repeatedly operated within short intervals, the window operation is disabled for some time.

## Initialising the power windows

If the windows cannot be closed automatically (e.g. after disconnecting the vehicle battery), a warning message is displayed in the Driver Information Centre.

Vehicle messages  103.

Activate the window electronics as follows:

1. Close doors.
2. Switch on ignition.
3. Pull switch until the window is closed and keep pulling for additional two seconds.
4. Push switch until the window is completely open and keep pushing for additional two seconds.
5. Repeat for each window.

## Heated rear window

Operated by pressing  together with heated exterior mirrors.

Heating works with the engine running and is switched off automatically after a short time.

Depending on climate control system,  is located at a different position.

## Vehicles with heating and ventilation system or air conditioning system



### Vehicles with electronic climate control system



### Heated windscreen

Operated by pressing . LED in button illuminates.

Heating works with the engine running and is switched off automatically after a short time.

Depending on climate control system,  is located at a different position.

### Vehicles with electronic climate control system



### Vehicles with air conditioning system



### Sun visors

The sun visors can be folded down or swivelled to the side to prevent dazzling.

If the sun visors have integral mirrors, the mirror covers should be closed when driving.

A ticket holder is located on the backside of the sun visor.

### Roller blinds



To reduce sunlight at the second row seats, pull the blind upwards using the grip and engage it at the top of the door frame.

## Roof

### Glass panel

Do not affix any stickers to the roof.  
Do not cover the vehicle using a tarpaulin.

### Sunblind



Press  gently to the first detent at the rear: the sunblind is opened as long as the switch is operated.

Press  firmly to the second detent and then release at the rear: the sunblind is opened as long as the switch is operated.

Press  gently to the first detent at the front: the sunblind is closed as long as the switch is operated.

Press  firmly to the second detent and then release at the front: the sunblind is closed as long as the switch is operated.

### Safety function

If the sunblind encounters resistance during automatic closing, it is immediately stopped and opened again.

### Function standby

In ignition switch position **1** the sunblind is operational ↻ 134.



### Initialising after a power failure

After a power failure, it may only be possible to operate the sunblind to a limited extent. Initialise the system as follows:

1. Turn key in ignition switch to position **1**.
2. Press  twice gently to the first detent at the rear, the sunblind opens slightly.

3. Immediately press  twice gently to the first detent at the front, the sunblind closes slightly.

After step 3 the sunblind is in initialising mode without safety function.

4. Press  gently to the first detent at the rear until the sunblind is completely opened.
5. Press  gently to the first detent at the front until the sunblind is completely closed.

After this procedure, the sunblind is initialised with safety function activated.

When  is pressed firmly to the second detent during initialising, the procedure is cancelled.

## Seats, restraints

<b>Head restraints</b> .....	<b>44</b>
Active head restraints .....	45
<b>Front seats</b> .....	<b>45</b>
Seat position .....	45
Manual seat adjustment .....	46
Power seat adjustment .....	48
Armrest .....	50
Heating .....	50
Ventilating .....	51
<b>Rear seats</b> .....	<b>51</b>
Armrest .....	51
Heating .....	51
<b>Seat belts</b> .....	<b>52</b>
Three-point seat belt .....	53
<b>Airbag system</b> .....	<b>55</b>
Front airbag system .....	58
Side airbag system .....	59
Curtain airbag system .....	59
Airbag deactivation .....	60
<b>Child restraints</b> .....	<b>61</b>
Child restraint systems .....	61
Child restraint installation locations .....	64

## Head restraints

### Position

#### ⚠ Warning

Only drive with the head restraint set to the proper position.

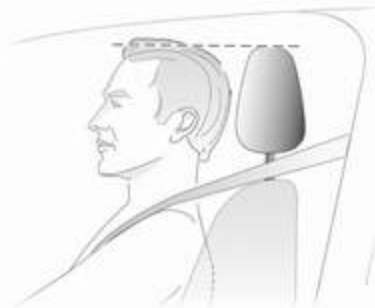

The upper edge of the head restraint should be at upper head level. If this is not possible for extremely tall people, set to highest position, and set to lowest position for small people.

## Adjustment

### Head restraints on front seats



### Height adjustment

Pull the head restraint upwards or press the catch to release and push the head restraint downwards.

## Head restraints on rear seats



### Height adjustment

Pull the head restraint upwards or press the catch to release and push the head restraint downwards.

### Removal

Press catch, pull the respective head restraint upwards and remove.

## Active head restraints

In the event of a rear-end impact, the front parts of the active head restraints are moved slightly

forwards. Thus the head is supported so that the risk of whiplash injury is reduced.

### Notice

Approved accessories may only be attached if the seat is not in use.

## Front seats

### Seat position

#### **⚠ Warning**

Only drive with the seat correctly adjusted.

#### **⚠ Warning**

Never adjust seats while driving as they could move uncontrollably.

#### **⚠ Danger**

Do not sit closer than 25 cm to the steering wheel, to permit safe airbag deployment.

#### **⚠ Warning**

Never store any objects under the seats.



- Sit with buttocks as far back against the backrest as possible. Adjust the distance between the seat and the pedals so that legs are slightly angled when pressing the pedals. Slide the front passenger seat as far back as possible.
- Set seat height high enough to have a clear field of vision on all sides and of all display instruments. There should be at least one hand of clearance between head and the roof frame. Your thighs should rest lightly on the seat without pressing into it.

- Sit with shoulders as far back against the backrest as possible. Set the backrest rake so that it is possible to easily reach the steering wheel with arms slightly bent. Maintain contact between shoulders and the backrest when turning the steering wheel. Do not angle the backrest too far back. We recommend a maximum rake of approx. 25°.
- Adjust seat and steering wheel in a way that the wrist rests on top of the steering wheel while the arm is fully extended and shoulders are on the backrest.
- Adjust the steering wheel ↻ 79.
- Adjust the head restraint ↻ 44.
- Adjust the height of the seat belt ↻ 53.
- Adjust the thigh support so that there is a space approx. two fingers wide between the edge of the seat and the hollow of the knee.
- Adjust the lumbar support so that it supports the natural shape of the spine.

## Manual seat adjustment

Drive only with engaged seats and backrests.

### Longitudinal adjustment



Pull handle, slide seat, release handle. Try to move the seat back and forth to ensure that the seat is locked in place.



**Backrest inclination**

Turn handwheel. Do not lean on backrest when adjusting.

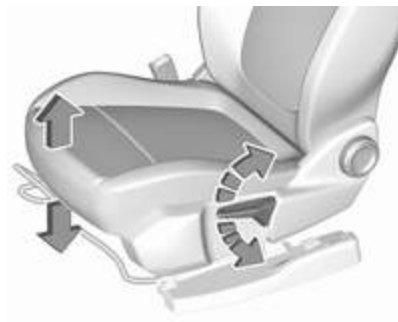
**Seat height**

Lever pumping motion

up : seat higher  
down : seat lower

**Seat inclination**

Press switch

at the rear : front end higher  
at the front : front end lower

### Lumbar support



Adjust lumbar support using the four-way switch to suit personal requirements.

Moving support up and down: push switch up or down.

Increasing and decreasing support: push switch forwards or backwards.

### Adjustable thigh support



Pull the lever and slide the thigh support.

### Power seat adjustment

#### **⚠ Warning**

Care must be taken when operating the power seats. There is a risk of injury, particularly for children. Objects could become trapped.

Keep a close watch on the seats when adjusting them. Vehicle passengers should be informed accordingly.

### Longitudinal adjustment



Move switch forwards/backwards.

### Seat height



Move switch upwards/downwards.

### Seat inclination



Move front of switch upwards/downwards.

### Backrest inclination



Turn switch forwards/backwards.

Lumbar support, adjustable thigh support, see manual seat adjustment ⇨ 46.

### Memory function for power seat adjustment

Two different driver's seat settings can be stored.

Vehicle personalisation ⇨ 104.



### Storing memory position

- Adjust driver's seat to desired position.
- Press and hold **M** and **1** or **2** simultaneously until a chime sounds.

### Recall of memory positions

Press and hold **1** or **2** until the stored seat position has been reached. Releasing the button during seat movement cancels the recall.

### Automatic recall of memory positions

Memory positions are each assigned to the respective radio remote control unit or electronic key.

The stored positions are automatically recalled when the ignition is switched on.

To stop recall movement, press one of the memory or power seat controls.

### Safety function

If the driver's seat encounters resistance during movement, the recall may stop. After removing the obstruction, press and hold the appropriate memory position button for two seconds. Try recalling the memory position again. If the recall does not operate, consult a workshop.

### Overload

If the seat setting is electrically overloaded, the power supply is automatically cut-off for a short time.

### Notice

After an accident in which airbags have been deployed, the memory function for each position button will be deactivated.

## Armrest

### Base armrest

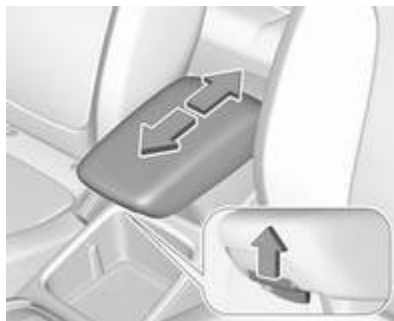

The armrest can be slid forwards by 10 cm. Pull the handle to slide the armrest. Under the armrest there is a storage compartment.

## Heating



Adjust heating to the desired setting by pressing  for the respective seat one or more times. The control indicator in the button indicates the setting.

Prolonged use of the highest setting for people with sensitive skin is not recommended.

Seat heating is operational when engine is running and during an Autostop.

Stop-start system ↗ 139.

## Ventilating



Activate ventilation by pressing  for the respective front seat.

Ventilated seats are operational when engine is running and during an Autostop.

Stop-start system ⇨ 139.

## Rear seats

### Armrest

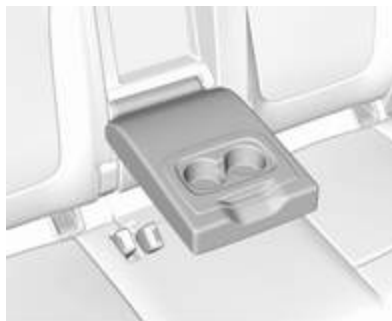

Fold armrest down. The armrest contains cupholders.

## Heating

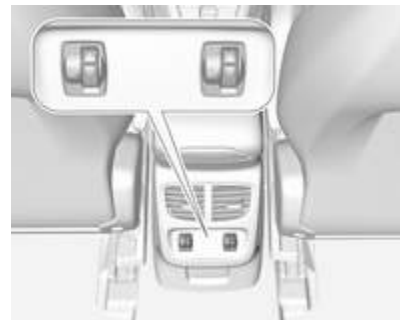

Adjust seat heating by turning thumb wheel  for the respective rear outer seat to the desired setting.

Prolonged use of the highest setting for people with sensitive skin is not recommended.

Seat heating is operational when engine is running and during an Autostop.

## Seat belts



The seat belts are locked during heavy acceleration or deceleration of the vehicle, holding the occupants in the seat position. Therefore the risk of injury is considerably reduced.

### ⚠ Warning

Fasten seat belt before each trip.

In the event of an accident, people not wearing seat belts endanger their fellow occupants and themselves.

Seat belts are designed to be used by only one person at a time. Child restraint system ⇨ 61.

Periodically check all parts of the belt system for damage, soiling and proper functionality.

Have damaged components replaced. After an accident, have the belts and triggered belt pretensioners replaced by a workshop.

### Notice

Make sure that the belts are not damaged by shoes or sharp-edged objects or are trapped. Prevent dirt from getting into the belt retractors.

### Seat belt reminder

Each seat is equipped with a seat belt reminder, indicated by a control indicator  for the respective seat in the roof console. ⇨ 93.

### Belt force limiters

Stress on the body is reduced by the gradual release of the belt during a collision.

## Belt pretensioners

In the event of a head-on, rear-end or side-on collision of a certain severity, the front and rear seat belts are tightened. The front seat belts are tightened by two pretensioners per seat. The outer rear seat belts are tightened by one pretensioner per seat.

### ⚠ Warning

Incorrect handling (e.g. removal or fitting of belts) can trigger the belt pretensioners.

Deployment of the belt pretensioners is indicated by continuous illumination of control indicator  ⇨ 93.

Triggered belt pretensioners must be replaced by a workshop. Belt pretensioners can only be triggered once.

### Notice

Do not affix or install accessories or other objects that may interfere with the operation of the belt pretensioners. Do not make any

modifications to belt pretensioner components as this will invalidate the operating permit of your vehicle.

## Three-point seat belt

### Fasten



Withdraw the belt from the retractor, guide it untwisted across the body and insert the latch plate into the buckle. Tighten the lap belt regularly whilst driving by pulling the shoulder belt.



Loose or bulky clothing prevents the belt from fitting snugly. Do not place objects such as handbags or mobile phones between the belt and your body.

### **⚠ Warning**

The belt must not rest against hard or fragile objects in the pockets of your clothing.

Seat belt reminder ,  93,  99

## Height adjustment



1. Pull belt out slightly.
2. Press the button to disengage the height adjuster and push it upwards or downwards.



Adjust the height so that the belt lies across the shoulder. It must not lie across the throat or upper arm.

Do not adjust while driving.

### Unfasten



To release belt, press red button on belt buckle.

### Using seat belts while pregnant



#### **⚠ Warning**

The lap belt must be positioned as low as possible across the pelvis to prevent pressure on the abdomen.



## Airbag system

The airbag system consists of a number of individual systems depending on the scope of equipment.

When triggered the airbags inflate within milliseconds. They also deflate so quickly that it is often unnoticeable during the collision.

### ⚠ Warning

The airbag system deploys in an explosive manner, repairs must be performed by skilled personnel only.

### ⚠ Warning

Adding accessories that change the vehicle's frame, bumper system, height, front end or side sheet metal, may keep the airbag system from working properly. The operation of the airbag system can also be affected by changing any parts of the front seats, seat belts,

airbag sensing and diagnostic module, steering wheel, instrument panel, inner door seals including the speakers, any of the airbag modules, ceiling or pillar trim, front sensors, side impact sensors or airbag wiring.

### Notice

The airbag systems and belt pretensioner control electronics are located in the centre console area. Do not put any magnetic objects in this area.

Do not affix any objects onto the airbag covers and do not cover them with other materials. Have damaged covers replaced by a workshop.

Each airbag is triggered only once. Have deployed airbags replaced by a workshop. Furthermore, it may be necessary to have the steering wheel, the instrument panel, parts of the panelling, the door seals, handles and the seats replaced.

Do not make any modifications to the airbag system as this will invalidate the vehicle operating permit.

Control indicator  for airbag systems  
⇨ 93.

## Child restraint systems on front passenger seat with airbag systems

Warning according to ECE R94.02:



**EN:** NEVER use a rearward-facing child restraint on a seat protected by an ACTIVE AIRBAG in front of it; DEATH or SERIOUS INJURY to the CHILD can occur.

**DE:** Nach hinten gerichtete Kindersitze NIEMALS auf einem Sitz verwenden, der durch einen davor befindlichen AKTIVEN AIRBAG

geschützt ist, da dies den TOD oder SCHWERE VERLETZUNGEN DES KINDES zur Folge haben kann.

**FR:** NE JAMAIS utiliser un siège d'enfant orienté vers l'arrière sur un siège protégé par un COUSSIN GONFLABLE ACTIF placé devant lui, sous peine d'infliger des BLESSURES GRAVES, voire MORTELLES à l'ENFANT.

**ES:** NUNCA utilice un sistema de retención infantil orientado hacia atrás en un asiento protegido por un AIRBAG FRONTAL ACTIVO. Peligro de MUERTE o LESIONES GRAVES para el NIÑO.

**RU:** ЗАПРЕЩАЕТСЯ устанавливать детское удерживающее устройство лицом назад на сиденье автомобиля, оборудованном фронтальной подушкой безопасности, если ПОДУШКА НЕ ОТКЛЮЧЕНА! Это может привести к СМЕРТИ или СЕРЬЕЗНЫМ ТРАВМАМ РЕБЕНКА.

**NL:** Gebruik NOOIT een achterwaarts gericht kinderzitje op een stoel met een ACTIEVE AIRBAG ervoor, om DODELIJK of ERNSTIG LETSEL van het KIND te voorkomen.

**DA:** Brug ALDRIG en bagudvendt autostol på et forsæde med AKTIV AIRBAG, BARNET kan komme i LIVSFARE eller komme ALVORLIGT TIL SKADE.

**SV:** Använd ALDRIG en bakåtvänd barnstol på ett säte som skyddas med en framförvarande AKTIV AIRBAG. DÖDSFALL eller ALLVARLIGA SKADOR kan drabba BARNET.

**FI:** ÄLÄ KOSKAAN sijoita taaksepäin suunnattua lasten turvaistuinta istuimelle, jonka edessä on AKTIIVINEN TURVATYYNY, LAPSI VOI KUOLLA tai VAMMAUTUA VAKAVASTI.

**NO:** Bakovervendt barnesikringsutstyr må ALDRI brukes på et sete med AKTIV KOLLISJONSPUTE foran, da det kan føre til at BARNET utsettes for LIVSFARE og fare for ALVORLIGE SKADER.

**PT:** NUNCA use um sistema de retenção para crianças voltado para trás num banco protegido com um AIRBAG ACTIVO na frente do mesmo, poderá ocorrer a PERDA DE VIDA ou FERIMENTOS GRAVES na CRIANÇA.

**IT:** Non usare mai un sistema di sicurezza per bambini rivolto all'indietro su un sedile protetto da AIRBAG ATTIVO di fronte ad esso: pericolo di MORTE o LESIONI GRAVI per il BAMBINO!

**EL:** ΠΟΤΕ μη χρησιμοποιείτε παιδικό κάθισμα ασφαλείας με φορά προς τα πίσω σε κάθισμα που προστατεύεται από μετωπικό ΕΝΕΡΓΟ ΑΕΡΟΣΑΚΟ, διότι το παιδί μπορεί να υποστεί ΘΑΝΑΣΙΜΟ ή ΣΟΒΑΡΟ ΤΡΑΥΜΑΤΙΣΜΟ.

**PL:** NIE WOLNO montować fotelika dziecięcego zwróconego tyłem do kierunku jazdy na fotelu, przed którym znajduje się WŁĄCZONA PODUSZKA POWIETRZNA. Niezastosowanie się do tego zalecenia może być przyczyną ŚMIERCI lub POWAŻNYCH OBRAŻEŃ u DZIECKA.

**TR:** Arkaya bakan bir çocuk emniyet sistemini KESİNLİKLE önünde bir AKTİF HAVA YASTIĞI ile korunmakta olan bir koltukta kullanmayınız. ÇOCUK ÖLEBİLİR veya AĞIR ŞEKİLDE YARALANABİLİR.

**UK:** НИКОЛИ не використовуйте систему безпеки для дітей, що встановлюється обличчям назад, на сидінні з УВІМКНЕНОЮ ПОДУШКОЮ БЕЗПЕКИ, інакше це може призвести до СМЕРТІ чи СЕРІОЗНОГО ТРАВМУВАННЯ ДИТИНИ.

**HU:** SOHA ne használjon hátrafelé néző biztonsági gyerekléssel előlről AKTÍV LÉGZSÁKKAL védett ülésen, mert a GYERMEK HALÁLÁT vagy KOMOLY SÉRÜLÉSÉT okozhatja.

**HR:** NIKADA nemojte koristiti sustav zadržavanja za djecu okrenut prema natrag na sjedalu s AKTIVNIM ZRAČNIM JASTUKOM ispred njega, to bi moglo dovesti do SMRTI ili OZBILJNIH OZLJEDA za DIJETE.

**SL:** NIKOLI ne nameščajte otroškega varnostnega sedeža, obrnjenega v nasprotni smeri vožnje, na sedež z

AKTIVNO ČELNO ZRAČNO BLAZINO, saj pri tem obstaja nevarnost RESNIH ali SMRTNIH POŠKODB za OTROKA.

**SR:** NIKADA ne koristiti bezbednosni sistem za decu u kome su deca okrenuta unazad na sedištu sa AKTIVNIM VAZDUŠNIM JASTUKOM ispred sedišta zato što DETE može da NASTRADA ili da se TEŠKO POVREDI.

**MK:** НИКОГАШ не користете детско седиште свртено назазад на седиште заштитено со АКТИВНО ВОЗДУШНО ПЕРНИЧЕ пред него, затоа што детето може ДА ЗАГИНЕ или да биде ТЕШКО ПОВРЕДЕНО.

**BG:** НИКОГА не използвайте детска седалка, гледаща назад, върху седалка, която е защитена чрез АКТИВНА ВЪЗДУШНА ВЪЗГЛАВНИЦА пред нея - може да се стигне до СМЪРТ или СЕРИОЗНО НАРАНЯВАНЕ на ДЕТЕТО.

**RO:** Nu utilizați NICIODATĂ un scaun pentru copil îndreptat spre partea din spate a mașinii pe un scaun protejat de un AIRBAG ACTIV în fața sa;

acest lucru poate duce la DECESUL sau VĂTĂMAREA GRAVĂ a COPILULUI.

**CS:** NIKDY nepoužívejte dětský zádržný systém instalovaný proti směru jízdy na sedadle, které je chráněno před sedadlem AKTIVNÍM AIRBAGEM. Mohlo by dojít k VÁŽNĚMU PORANĚNÍ nebo ÚMRTÍ DÍTĚTE.

**SK:** NIKDY nepoužívajte detskú sedačku otočenú vzad na sedadle chránenom AKTÍVNÝM AIRBAGOM, pretože môže dôjsť k SMRTI alebo VÁŽNYM ZRANENIAM DIEŤAŤA.

**LT:** JOKIU BŪDU nemontuokite atgal atgręžtos vaiko tvirtinimo sistemas sėdynėje, prieš kurią įrengta AKTYVI ORO PAGALVĖ, nes VAIKAS GALI ŽŪTI arba RIMTAI SUSIŽALOTI.

**LV:** NEKĀDĀ GADĪJUMĀ neizmantojiet uz aizmuguri vērstu bērnu sēdekļīti sēdvietā, kas tiek aizsargāta ar tās priekšā uzstādītu AKTĪVU DROŠĪBAS SPILVENU, jo pretējā gadījumā BĒRNS var gūt SMAGAS TRAUMAS vai IET BOJĀ.

**ET:** ÄRGE kasutage tahapoole suunatud lapseturvaistet istmel, mille ees on AKTIIVSE TURVAPADJAGA kaitstud iste, sest see võib põhjustada LAPSE SURMA või TÕSISE VIGASTUSE.

**MT:** QATT tuża trażżin għat-tfal li jħares lejn in-naħa ta' wara fuq sit protett b'AIRBAG ATTIV quddiemu; dan jista' jikkawża l-MEWT jew GRIEHI SERJI lit-TFAL.

**GA:** Ná húsáid srian sábháilteachta linbh cúil RIAMH ar shuíochán a bhfuil mála aeir ag feidhmiú os a chomhair. Tá baol BÁIS nó GORTÚ DONA don PHÁISTE ag baint leis.

Beyond the warning required by ECE R94.02, for safety reasons a forward-facing child restraint system must only be used subject to the instructions and restrictions in the table ⇨ 64.

### **⚠ Danger**

Do not use a child restraint system on the passenger seat with active front airbag.

The airbag label is located on both sides of the front passenger sun visor.  
Airbag deactivation ⇨ 60.

## Front airbag system

The front airbag system consists of one airbag in the steering wheel and one in the instrument panel on the front passenger side. These can be identified by the word **AIRBAG**.

The front airbag system is triggered in the event of a front-end impact of a certain severity. The ignition must be switched on.

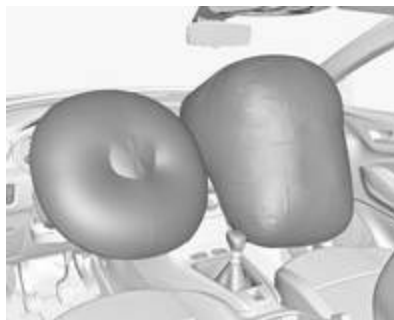

The inflated airbags cushion the impact, thereby reducing the risk of injury to the upper body and head of the front seat occupants considerably.

### **⚠ Warning**

Optimum protection is only provided when the seat is in the proper position.

Seat position ⇨ 45.

Keep the area in which the airbag inflates clear of obstructions.

Fit the seat belt correctly and engage securely. Only then is the airbag able to protect.

## Side airbag system



The side airbag system consists of an airbag in each front and outer rear seat backrest. This can be identified by the word **AIRBAG**.

The side airbag system is triggered in the event of a side impact of a certain severity. The ignition must be switched on.



The inflated airbags cushion the impact, thereby reducing the risk of injury to the upper body and pelvis in the event of a side-on collision considerably.

### **⚠ Warning**

Keep the area in which the airbag inflates clear of obstructions.

### **Notice**

Only use protective seat covers that have been approved for the vehicle. Be careful not to cover the airbags.

## Curtain airbag system

The curtain airbag system consists of an airbag in the roof frame on each side. This can be identified by the word **AIRBAG** on the roof pillars.

The curtain airbag system is triggered in the event of a side-on impact of a certain severity. The ignition must be switched on.



The inflated airbags cushion the impact, thereby reducing the risk of injury to the head in the event of a side-on impact considerably.

### ⚠ Warning

Keep the area in which the airbag inflates clear of obstructions.

The hooks on the handles in the roof frame are only suitable for hanging up light articles of clothing, without coat hangers. Do not keep any items in these clothes.



### Airbag deactivation

The front passenger airbag system must be deactivated for child restraint system on the passenger seat according to the instructions in the table ⇨ 64. The side airbag and curtain airbag systems, the belt pretensioners and all driver airbag systems will remain active.



The front passenger airbag system can be deactivated via a key-operated switch in the glovebox.

Use the ignition key to choose the position:

- OFF  : front passenger airbag is deactivated and will not inflate in the event of a collision. Control indicator OFF  illuminates continuously in the centre console. A child restraint system can be installed in accordance with the chart **Child restraint installation locations** ⇨ 64. No adult person is allowed to occupy the front passenger seat
- ON  : front passenger airbag is active. A child restraint system must not be installed

### ⚠ Danger

Deactivate passenger airbag only in combination with the use of a child restraint system, subject to the instructions and restrictions in the table ⇨ 64.

Otherwise, there is a risk of fatal injury for a person occupying a seat with a deactivated front passenger airbag.



If the control indicator ☹ illuminates for approx. 60 seconds after the ignition is switched on, the front passenger airbag system will inflate in the event of a collision.

If the control indicator ☹ illuminates after the ignition is switched on, the front passenger airbag system is deactivated. It stays on while the airbag is deactivated.

If both control indicators are illuminated at the same time, there is a system failure. The status of the system is not discernible, therefore no person is allowed to occupy the front passenger seat. Contact a workshop immediately.

Consult a workshop immediately if neither of the two control indicators are illuminated.

Change status only when the vehicle is stopped with the ignition off.

Status remains until the next change.

Control indicator for airbag deactivation ⇨ 94.

## Child restraints

### Child restraint systems

#### ⚠ Danger

If using a rear-facing child restraint system on the front passenger seat, the airbag system for the front passenger seat must be deactivated. This also applies to certain forward-facing child restraint systems as indicated in the tables ⇨ 64.

Airbag deactivation ⇨ 60, Airbag label ⇨ 55.

We recommend a child restraint system which is tailored specifically to the vehicle. For further information, contact your workshop.

Before fastening a child seat adjust the head restraint to use position ⇨ 44.

When a child restraint system is being used, pay attention to the following usage and installation instructions and also those supplied with the child restraint system.

Always comply with local or national regulations. In some countries, the use of child restraint systems is forbidden on certain seats.

Child restraint systems can be fastened with:

- Three-point seat belt
- ISOFIX brackets
- Top-tether

### Three-point seat belt

Child restraint systems can be fastened by using a three-point seat belt. Depending on the size of the used child restraint systems, up to two child restraint systems can be attached to the outboard seats.

⇨ 64.

### ISOFIX brackets



Fasten vehicle-approved ISOFIX child restraint systems to the ISOFIX mounting brackets. Specific vehicle ISOFIX child restraint system positions are marked in the ISOFIX table ⇨ 64.

ISOFIX mounting brackets are indicated by a label on the backrest.

An i-size child restraint system is an universal ISOFIX child restraint system according UN Regulation No. 129.

All i-size child restraint systems can be used on any vehicle seat suitable for i-size, i-size table ⇨ 64.

Either a Top-tether strap or a support leg must be used in addition to the ISOFIX mounting brackets.



i-size child seats and vehicle seats with i-size approval are marked with i-size symbol, see illustration.

### Top-tether anchors

Top-tether anchors are marked with the symbol  for a child seat.





In addition to the ISOFIX mounting brackets, fasten the Top-tether strap to the Top-tether anchors.

ISOFIX child restraint systems of universal category positions are marked in the table by IUF ⇨ 64.

### Selecting the right system

The rear seats are the most convenient location to fasten a child restraint system.

Children should travel facing rearwards in the vehicle as long as possible. This makes sure that the child's backbone, which is still very weak, is under less strain in the event of an accident.

Suitable are child restraint systems that comply with valid UN ECE regulations. Check local laws and regulations for mandatory use of child restraint systems.

The following child restraints are recommended for the following weight classes:

- **Group 0, Group 0+:**  
Maxi Cosi Cabriofix with or without ISOFIX base for children up to 13 kg
- **Group I:** Duo Plus with ISOFIX and Top-tether for children from 9 kg to 18 kg
- **Group II, Group III:** Kidfix XP with or without ISOFIX for children from 15 kg to 36 kg
- **Group III:** Graco Booster for children from 22 kg to 36 kg

Ensure that the child restraint system to be installed is compatible with the vehicle type.

Ensure that the mounting location of the child restraint system within the vehicle is correct, see following tables.

Allow children to enter and exit the vehicle only on the side facing away from the traffic.

When the child restraint system is not in use, secure the seat with a seat belt or remove it from the vehicle.

### Notice

Do not affix anything on the child restraint systems and do not cover them with any other materials.

A child restraint system which has been subjected to stress in an accident must be replaced.

## Child restraint installation locations

### Permissible options for fastening a child restraint system with a three-point seat belt

Weight class	On front passenger seat		On rear outboard seats	On rear centre seat
	activated airbag	deactivated airbag		
<b>Group 0: up to 10 kg</b>	X	U <sup>1,2</sup>	U/L <sup>3</sup>	U
<b>Group 0+: up to 13 kg</b>	X	U <sup>1,2</sup>	U/L <sup>3</sup>	U
<b>Group I: 9 to 18 kg</b>	X	U <sup>1,2</sup>	U/L <sup>3,4</sup>	U <sup>4</sup>
<b>Group II: 15 to 25 kg</b>	U <sup>1,2</sup>	X	U/L <sup>3,4</sup>	U <sup>4</sup>
<b>Group III: 22 to 36 kg</b>	U <sup>1,2</sup>	X	U/L <sup>3,4</sup>	U <sup>4</sup>

U : universal suitability in conjunction with three-point seat belt

L : suitable for particular child restraint systems of the 'specific-vehicle', 'restricted' or 'semi-universal' categories. The child restraint system must be approved for the specific vehicle type (refer to the vehicle type list of the child restraint system)

X : no child restraint system permitted in this weight class

<sup>1</sup> : move seat forwards as far as necessary and adjust seat backrest inclination as far as necessary to a vertical position to ensure that the belt runs forwards from the upper anchorage point

<sup>2</sup> : move seat height adjustment upwards as far as necessary and adjust seat backrest inclination as far as necessary to a vertical position to ensure that the belt is tight on the buckle side

<sup>3</sup> : move the respective front seat ahead of the child restraint system forwards as far as necessary

<sup>4</sup> : adjust the respective headrest as necessary or remove if required

## Permissible options for fitting an ISOFIX child restraint system with ISOFIX brackets

Weight class	Size class	Fixture	On front passenger seat		On rear outboard seats	On rear centre seat
			activated airbag	deactivated airbag		
Group 0: up to 10 kg	G	ISO/L2	X	X	X	X
	F	ISO/L1	X	X	X	X
	E	ISO/R1	X	IL	IL <sup>3</sup>	X
Group 0+: up to 13 kg	E	ISO/R1	X	IL	IL <sup>3</sup>	X
	D	ISO/R2	X	IL	IL <sup>3</sup>	X
	C	ISO/R3	X	IL	IL <sup>3</sup>	X
Group I: 9 to 18 kg	D	ISO/R2	X	IL	IL <sup>3,4</sup>	X
	C	ISO/R3	X	IL	IL <sup>3,4</sup>	X
	B	ISO/F2	X	IL, IUF	IL, IUF <sup>3,4</sup>	X
	B1	ISO/F2X	X	IL, IUF	IL, IUF <sup>3,4</sup>	X
	A	ISO/F3	X	IL, IUF	IL, IUF <sup>3,4</sup>	X
Group II: 15 to 25 kg			X	X	IL <sup>3,4</sup>	X
Group III: 22 to 36 kg			X	X	IL <sup>3,4</sup>	X

- IL : suitable for particular ISOFIX restraint systems of the 'specific-vehicle', 'restricted' or 'semi-universal' categories.  
The ISOFIX restraint system must be approved for the specific vehicle type (refer to the vehicle type list of the child restraint system)
- IUF : suitable for ISOFIX forward-facing child restraint systems of universal category approved for use in this weight class
- X : no ISOFIX child restraint system approved in this weight class
- 1 : move seat forwards as far as necessary and adjust seat backrest inclination as far as necessary to a vertical position to ensure that the belt runs forwards from the upper anchorage point
- 2 : move seat height adjustment upwards as far as necessary and adjust seat backrest inclination as far as necessary to a vertical position to ensure that the belt is tight on the buckle side
- 3 : move the respective front seat ahead of the child restraint system forwards as far as necessary
- 4 : adjust the respective headrest as necessary or remove if required

#### ISOFIX size class and seat device

- A – ISO/F3 : forward-facing child restraint system for children of maximum size in the weight class 9 to 18 kg
- B – ISO/F2 : forward-facing child restraint system for smaller children in the weight class 9 to 18 kg
- B1 – ISO/F2X : forward-facing child restraint system for smaller children in the weight class 9 to 18 kg
- C – ISO/R3 : rear-facing child restraint system for children of maximum size in the weight class up to 18 kg
- D – ISO/R2 : rear-facing child restraint system for smaller children in the weight class up to 18 kg
- E – ISO/R1 : rear-facing child restraint system for young children in the weight class up to 13 kg
- F – ISO/L1 : left lateral facing position child restraint system (carry-cot)
- G – ISO/L2 : right lateral facing position child restraint system (carry-cot)

#### Permissible options for fitting an i-Size child restraint system with ISOFIX brackets

##### On front passenger seat

	activated airbag	deactivated airbag	On rear outboard seats	On rear centre seat
--	------------------	--------------------	------------------------	---------------------

i-Size child restraint systems	X	i - U	i - U	X
--------------------------------	---	-------	-------	---

- 
- i - U : suitable for i-Size 'universal' forward and rearward facing child restraint systems
  - X : seating position not suitable for i-Size 'universal' child restraint systems.

## Storage

<b>Storage compartments</b> .....	<b>68</b>
Glovebox .....	68
Cupholders .....	68
Centre console storage .....	69
<b>Load compartment</b> .....	<b>69</b>
Load compartment cover .....	71
Rear floor storage cover .....	72
Lashing eyes .....	73
Safety net .....	73
Warning triangle .....	75
First aid kit .....	75
<b>Roof rack system</b> .....	<b>75</b>
Roof rack .....	75
<b>Loading information</b> .....	<b>76</b>

## Storage compartments

### ⚠ Warning

Do not store heavy or sharp objects in the storage compartments. Otherwise, the storage compartment lid could open and vehicle occupants could be injured by objects being thrown around in the event of hard braking, a sudden change in direction or an accident.

### Glovebox



On some versions the glovebox is ventilated. Air ventilation and temperature depend on the settings of the climate control system. The air vent in the glove box can be closed ↻ 131.

Other versions may have a CD player in the glove box.

The glovebox should be closed whilst driving.

### Cupholders



Cupholders are located in the centre console.

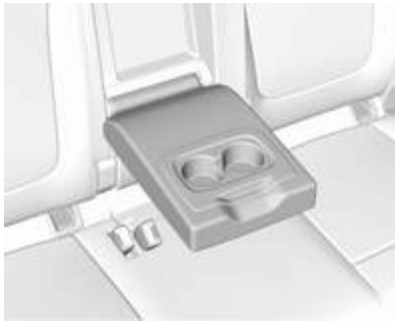

Additional cupholders are located in the rear armrest. Fold down armrest.

### Centre console storage



The storage container can be used to store small items.

Depending on the version, the storage compartment is located under a cover.

### Load compartment

The rear seat backrest is divided into 2/3 to 1/3 parts. Both parts can be folded down individually to increase the size of the load compartment.

Before folding rear seat backrests, execute the following if necessary:

- Move front seats forward if necessary.
- Remove the load compartment cover ↻ 71.
- Press and hold the catch to push the head restraints down ↻ 44.

### Load compartment extension

- Check that the outer seat belts are lying correctly on the backrests.

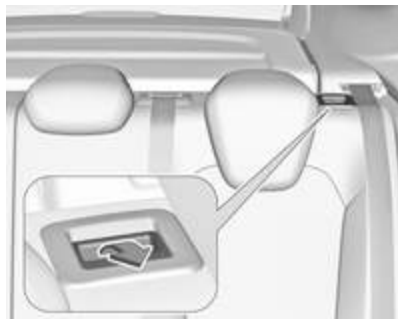

- Pull the release lever on one or both outer sides and fold down the backrests onto the seat cushion.



- Alternatively fold seat backrests from the load compartment: pull switch on left or right sidewall of the load compartment to fold the corresponding part of the rear seat backrest.

### **⚠ Warning**

Take care when operating the rear backrests from the load compartment. The backrest is folded with considerable power. Risk of injury, particularly to children.

Ensure that nothing is attached to the rear seats or located on the seat cushion.

- To fold up, raise the backrests and guide them into an upright position until they engage audibly.

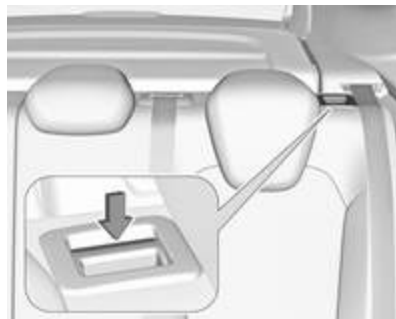

### **⚠ Warning**

When folding up, ensure that backrests are securely locked in position before driving. Failure to do so may result in personal injury or damage to the load or vehicle in the event of hard braking or a collision.



### Opening the pass through in the centre backrest



Fold down the rear armrest.



Pull grip and open the cover.

Suitable for loading long, narrow objects.

### Load compartment cover

Do not place any objects on the cover.

### Removing cover



Unhook retaining straps from tailgate.



Lift cover at the rear and push it upwards at the front.

Remove the cover.

### Fitting cover

Engage cover in side guides and fold downwards. Attach the retaining straps to the tailgate.

## Rear floor storage cover



The rear floor cover can be lifted and removed. Raise cover at the loop and remove.



To hold the load compartment cover in an upright position, lift it up past the retractable stops.

## Double load floor

The double load floor can be inserted in the load compartment in two positions:

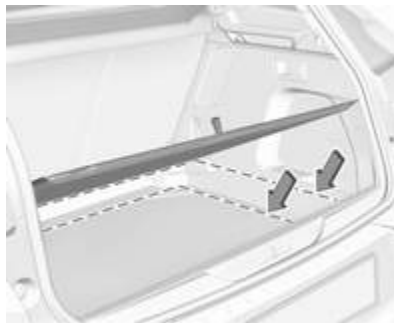

- lower position above the spare wheel well cover
- upper position interlocked with the grab handle into back panel trim



To remove, press the handle to unlock the load floor and lift it up while using the handle.

If mounted in the upper position, the space between the load floor and the spare wheel well cover can be used as a storage compartment.

In this position, if the rear seat backrests are folded forwards, an almost completely flat load bay is created.

In the upper position, the double load floor is able to withstand a maximum load of 100 kg. In the lower position, the double load floor is able to withstand the maximum load of 150 kg.

## Lashing eyes



The lashing eyes are designed to secure items against slippage, e.g. using lashing straps or luggage net.

## Safety net

The safety net can be installed behind the rear seats or, if the rear seat backrests are folded, behind the front seats.

Passengers must not be transported behind the safety net.

## Installation

### Behind the rear seats



- There are installation openings on both sides in the roof frame above the rear seats: suspend and engage rod of net at one side, compress rod and suspend and engage at the other side.



- Attach the hooks of safety net straps in the lashing eyes behind the rear seats.
- Tension both straps by pulling at the loose end.
- Rear seat backrests must be raised up.

## Behind the front seats



- There are installation openings on both sides in the roof frame above the front seats: suspend and engage rod of net at one side, compress rod and suspend and engage at the other side.

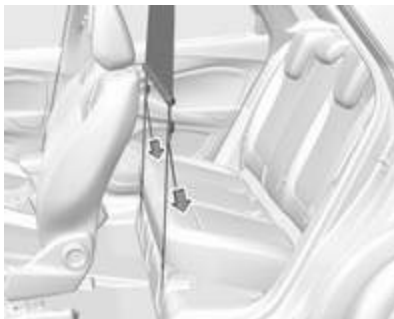

- Attach hooks of safety net straps to loops in the floor in front of the rear seats. To get access to the loops, push in the perforated parts in the floor cover on both sides. Attach the hooks to the loops.
- Tension both straps by pulling at the loose end.
- Push down head restraints and fold down rear seat backrests ↪ 69.

## Removal

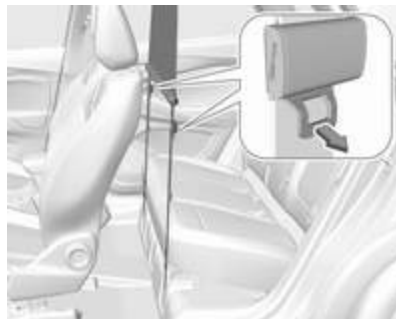

Pull the flap at the tightener on both sides to release the straps. Detach hooks from the eyes.

Unhook the safety net rods from the brackets in the roof frame.

Roll up the net and secure with a strap.

## Warning triangle



Stow the warning triangle in the space on the inside of the tailgate and secure it with the velcro fastener.

## First aid kit



Stow the first aid kit in the stowage compartment on the right side of the load compartment.

## Roof rack system

### Roof rack

For safety reasons and to avoid damage to the roof, the vehicle-approved roof rack system is recommended.

Follow the installation instructions and remove the roof rack when not in use.

### Vehicles with roof railing



Fasten the roof rack in the roof railing above the mounting points located in each door frame of the vehicle body.

### Vehicles without roof railing



Open all doors.

Mounting points are located in each door frame of the vehicle body.

Detach the cover from each mounting point and fasten the roof rack with the attached screws.

### Loading information



- Heavy objects in the load compartment should be placed against the seat backrests. Make sure that the backrests are securely engaged, i.e. no longer showing the red markings on the side near the release lever. If objects can be stacked, heavier objects should be placed at the bottom.
- Secure objects with lashing straps attached to lashing eyes ↻ 73.
- Secure loose objects in the load compartment to prevent from sliding.
- When transporting objects in the load compartment, the backrests of the rear seats must not be angled forward.
- Do not allow the load to protrude above the upper edge of the backrests.
- Do not place any objects on the load compartment cover or the instrument panel, and do not cover the sensor on top of the instrument panel.
- The load must not obstruct the operation of the pedals, parking brake and gear selector, or hinder the freedom of movement of the driver. Do not place any unsecured objects in the interior.
- Do not drive with an open load compartment.

**⚠ Warning**

Always make sure that the load in the vehicle is securely stowed. Otherwise objects can be thrown around inside the vehicle and cause personal injury or damage to the load or car.

- The payload is the difference between the permitted gross vehicle weight (see identification plate ⇨ 238) and the EC kerb weight.  
To calculate the payload, enter the data for your vehicle in the weights table at the front of this manual.  
The EC kerb weight includes weights for the driver (68 kg), luggage (7 kg) and all fluids (fuel tank 90% full).  
Optional equipment and accessories increase the kerb weight.
- Driving with a roof load increases the sensitivity of the vehicle to cross-winds and has a

detrimental effect on vehicle handling due to the vehicle's higher centre of gravity.

Distribute the load evenly and secure it properly with retaining straps. Adjust the tyre pressure and vehicle speed according to the load conditions. Check and retighten the straps frequently.

Do not drive faster than 75 mph.

The permissible roof load is 85 kg. The roof load is the combined weight of the roof rack and the load.

# Instruments and controls

<b>Controls</b> .....	<b>79</b>
Steering wheel adjustment .....	79
Steering wheel controls .....	79
Heated steering wheel .....	79
Horn .....	80
Windscreen wiper/washer .....	80
Rear window wiper/washer .....	82
Outside temperature .....	82
Clock .....	83
Power outlets .....	84
Inductive charging .....	85
Cigarette lighter .....	86
Ashtrays .....	86
<b>Warning lights, gauges and indicators</b> .....	<b>87</b>
Instrument cluster .....	87
Speedometer .....	89
Odometer .....	90
Trip odometer .....	90
Tachometer .....	90
Fuel gauge .....	91
Engine coolant temperature gauge .....	91
Service display .....	91

Control indicators .....	92
Turn signal .....	93
Seat belt reminder .....	93
Airbag and belt tensioners .....	93
Airbag deactivation .....	94
Charging system .....	94
Malfunction indicator light .....	94
Stop engine .....	94
System check .....	95
Brake and clutch system .....	95
Electric parking brake .....	95
Electric parking brake fault .....	95
Antilock brake system (ABS) .....	95
Gear shifting .....	96
Lane departure warning .....	96
Lane keep assist .....	96
Electronic Stability Control and Traction Control system .....	96
Engine coolant temperature .....	96
Preheating .....	97
Diesel particle filter .....	97
AdBlue .....	97
Deflation detection system .....	97
Engine oil pressure .....	97
Low fuel .....	98
Autostop .....	98
Exterior light .....	98
High beam .....	98
High beam assist .....	98
LED headlights .....	98

Fog light .....	98
Rear fog light .....	98
Rain sensor .....	98
Cruise control .....	99
Adaptive cruise control .....	99
Vehicle detected ahead .....	99
Speed limiter .....	99
Door open .....	99
<b>Information displays</b> .....	<b>99</b>
Driver Information Centre .....	99
Info display .....	101
<b>Vehicle messages</b> .....	<b>103</b>
Warning chimes .....	103
Battery voltage .....	104
<b>Vehicle personalisation</b> .....	<b>104</b>
<b>Telematics service</b> .....	<b>108</b>
OnStar .....	108



## Controls

### Steering wheel adjustment



Unlock lever, adjust steering wheel, then engage lever and ensure it is fully locked.

Do not adjust steering wheel unless vehicle is stationary and steering wheel lock has been released.

### Steering wheel controls

Some driver assistance systems, Infotainment system and a connected mobile phone can be operated via the controls on the steering wheel.



Further information is available in the Infotainment manual.

Driver assistance systems ⇨ 158.

### Heated steering wheel



Activate heating by pressing . Activation is indicated by the LED in the button.



The recommended grip areas of the steering wheel are heated quicker and to a higher temperature than the other areas.

Heating is operational when the engine is running and during an Autostop.

Stop-start system ⇨ 139.

## Horn



Press .

## Windscreen wiper/washer

### Windscreen wiper with adjustable wiper interval



**HI** : fast  
**LO** : slow  
**INT** : interval wiper  
**OFF** : off

For a single wipe when the windscreen wiper is off, press the lever down to position **1x**.

Do not use if the windscreen is frozen.

Switch off in car washes.

### Adjustable wiper interval



Wiper lever in position **INT**.

Turn the adjuster wheel to adjust the desired wipe interval:

short interval : turn adjuster wheel upwards  
 long interval : turn adjuster wheel downwards

### Windscreen wiper with rain sensor



- HI** : fast  
**LO** : slow  
**AUTO** : automatic wiping with rain sensor  
**OFF** : off

In **AUTO** position, the rain sensor detects the amount of water on the windscreen and automatically regulates the frequency of the windscreen wiper.

For a single wipe when the windscreen wiper is off, press the lever downwards to position **1x**.

Do not use if the windscreen is frozen.

Switch off in car washes.

### Adjustable sensitivity of the rain sensor



Turn the adjuster wheel to adjust the sensitivity:

- low sensitivity : turn adjuster wheel downwards  
 high sensitivity : turn adjuster wheel upwards



Keep the sensor free from dust, dirt and ice.

Control indicator   80.

### Windscreen washer



Pull lever. Washer fluid is sprayed onto the windscreen and the wiper wipes a few times.

Washer fluid ⇨ 207.

## Rear window wiper/washer

### Rear window wiper



Turn outer cap to activate the rear window wiper:

- OFF** : off
- INT** : intermittent operation
- ON** : continuous operation

Do not use if the rear window is frozen.

Switch off in car washes.

The rear window wiper comes on automatically when the windscreen wiper is switched on and reverse gear is engaged.

Activation or deactivation of this function can be changed in the Vehicle personalisation menu ⇨ 104.

### Rear window washer



Push lever.

Washer fluid is sprayed onto the rear window and the wiper wipes a few times.

The rear window washer system is deactivated when the fluid level is low.

Washer fluid ⇨ 207.

## Outside temperature

A drop in temperature is indicated immediately and a rise in temperature after a time delay.



Illustration shows an example.

If outside temperature drops to 3 °C, a warning message is displayed in the Driver Information Centre.

### ⚠ Warning

The road surface may already be icy even though the display indicates a few degrees above 0 °C.

## Clock

Date and time are shown in the Info-Display.

Info-Display ⇨ 101.

## Graphic-Info-Display

Press **MENU** to open the menu page.

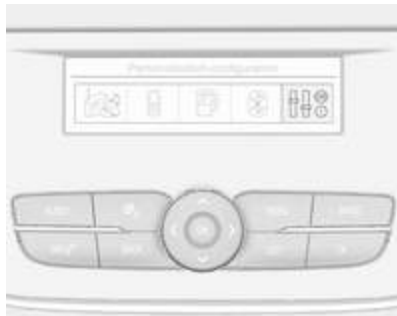

Select **⌘**.

Select **Display configuration**.

Select **Date and time adjustment**.

Set successively the respective values for date and time by using the four way switch. Confirm with **OK**.

## 7" Colour-Info-Display

Press **⇨** and then select **Settings**.

Select **Time and Date** to display the respective submenu.



## Set Time Format

To select the desired time format, touch the screen buttons **12 h** or **24 h**.

## Set Date Format

To select the desired date format, select **Set Date Format** and choose between the available options in the submenu.

## Auto Set

To choose whether time and date are to be set automatically or manually, select **Auto Set**.

For time and date to be set automatically, select **On - RDS**.

For time and date to be set manually, select **Off - Manual**. If **Auto Set** is set to **Off - Manual**, the submenu items **Set Time** and **Set Date** become available.

## Set time and date

To adjust the time and date settings, select **Set Time** or **Set Date**.

Touch **+** and **-** to adjust the settings.

## 8" Colour-Info-Display

Press **SET** and then select the **OPTIONS**.



Select **Setting the time-data**.

To change the time and date formats, select the respective tabs and then select the desired formats.

By default the displayed time and date is automatically adjusted by the system.

To manually adjust the displayed time and date:

Select the **Time** tab.

Set **Synchronization with GPS (UTC)**: to **Micro OFF** and then select the **Time** field to set the desired time.

Select the **Date** tab and then select the **Date**: field to set the desired date.

## Power outlets



A 12 Volt power outlet is located behind the storage cover below the climate controls. Press cover to open.



Further 12 Volt power outlets are located in the rear console



and at the left sidewall in the load compartment.

Do not exceed the maximum power consumption of 120 watts.



A 230 Volt power outlet may also be located in the rear console.

Do not exceed the maximum power consumption of 150 watts.

With ignition off, the power outlets are deactivated. Additionally the power outlets are deactivated in the event of low vehicle battery voltage.

Electrical accessories that are connected must comply with the electromagnetic compatibility requirements laid down in DIN VDE 40 839.

Do not connect any current-delivering accessories, e.g. electrical charging devices or batteries.

Do not damage the outlet by using unsuitable plugs.

Stop-start system ⇨ 139.

### USB charging ports



An USB port is located behind the storage cover below the climate controls. Press cover to open.

The USB port has also a data connection to the Infotainment system. For further information, see Infotainment manual.



A further USB port is located in the rear console.

The USB ports are prepared for charging devices.

#### Notice

The sockets must always be kept clean and dry.

### Inductive charging

#### ⚠ Warning

Inductive charging can affect the operation of implanted pacemakers or other medical

devices. If applicable, seek medical advice before using the inductive charging device.

### **Warning**

Remove any metal objects from the charging device before charging a mobile phone, as these objects could become very hot.



To charge a device, the ignition must be switched on.

The charging area is located below the armrest in the centre console.

To charge a mobile phone:

1. Remove all objects from the charging device.
2. Place the mobile phone with the display facing upwards on the charging device in the storage. Use the elastic band to secure the mobile phone.

Charging status is indicated in the LED: illuminates green, when mobile phone is charging.

PMA or Qi compatible mobile phones can be charged inductively.

A back cover with an integrated coil (e.g. Samsung 4 and 5) or a jacket (e.g. some iPhone models) may be required to charge a mobile phone.

Protective cover for the mobile phone could have impact on the inductive charging.

In the event that the mobile device is not charging properly, rotate it 180° and place it on the charging device again.

## Cigarette lighter



The cigarette lighter is located behind the storage cover below the climate controls. Press cover to open.

Press in cigarette lighter. It switches off automatically once the element is glowing. Pull out lighter.

## Ashtrays

### **Caution**

To be used only for ash and not for combustible rubbish.





A portable ashtray can be placed in the cupholders.













## Warning lights, gauges and indicators

















### Instrument cluster







The following instrument cluster is available:



## Overview

-  Turn signal ⇨ 93
-  Seat belt reminder ⇨ 93
-  Airbag and belt tensioners ⇨ 93
-  Airbag deactivation ⇨ 94
-  Charging system ⇨ 94
-  Malfunction indicator light ⇨ 94
-  Service vehicle soon ⇨ 91
- STOP** Stop engine ⇨ 94
-  System check ⇨ 95
-  Brake and clutch system ⇨ 95
-  Electric parking brake ⇨ 95
-  Antilock brake system (ABS) ⇨ 95
-  Gear shifting ⇨ 96
-  Lane departure warning ⇨ 96

-  Lane keep assist ⇨ 96
-  Electronic Stability Control and Traction Control system ⇨ 96
-  Preheating ⇨ 97
-  Diesel particle filter ⇨ 97
-  AdBlue ⇨ 97
-  Deflation detection system ⇨ 97
-  Engine oil pressure ⇨ 97
-  Low fuel ⇨ 98
-  Engine coolant temperature high ⇨ 96
-  Autostop ⇨ 98
-  Exterior light ⇨ 98
-  Low beam ⇨ 112
-  High beam ⇨ 98
-  High beam assist ⇨ 98
-  Fog light ⇨ 98
-  Rear fog light ⇨ 98

-  Rain sensor ⇨ 98
-  Side blind spot alert ⇨ 182
-  Cruise control ⇨ 99
-  Speed limiter ⇨ 99
-  Forward collision alert ⇨ 169,  
Active emergency braking ⇨ 170,  
Front pedestrian protection ⇨ 173
-  Door open ⇨ 99

## Speedometer



Indicates vehicle speed.

## Odometer

The total recorded distance is displayed in miles.

## Driver Information Centre



## Trip odometer



The recorded distance since the last reset is displayed in the Driver Information Centre.

Trip odometer counts up to 9,999 miles and then restarts at 0.

Press **000** for 2 seconds to reset trip odometer.

Two trip odometer pages are selectable in the trip/fuel information menu for different trips ↻ 99.

## Tachometer



Displays the engine speed.

Drive in a low engine speed range for each gear as much as possible.

### Caution

If the needle is in the red warning zone, the maximum permitted engine speed is exceeded. Engine at risk.

## Fuel gauge



Displays the level in the fuel tank.

Control indicator ● illuminates if the level in the tank is low.

Never run the fuel tank dry.

Because of the fuel remaining in the tank, the top-up quantity may be less than the specified fuel tank capacity.

## Engine coolant temperature gauge



Displays the coolant temperature.

- 50 : engine operating temperature not yet reached
- 90 : normal operating temperature
- 130 : temperature too high

Control indicator ● illuminates if coolant temperature is too high.  
Switch off engine immediately.

### Caution

If engine coolant temperature is too high, stop vehicle, switch off engine. Danger to engine. Check coolant level.

## Service display

The service system informs when to change the engine oil and filter or a vehicle service is required. Based on driving conditions, the interval at which an engine oil and filter change is required can vary considerably. Service information ⇨ 234





A required service due is displayed in the Driver Information Centre for seven seconds after switching on the ignition.



If no service is required for the next 3000 km or more no service information appears in the display.

If service due is required within the next 3000 km, the remaining distance or time duration is indicated for several seconds. Simultaneously symbol  lights up permanently as reminder.



If service due is less than 1000 km,  flashes and then lights up permanently. Remaining distance or time duration is indicated for several seconds.

Overdue service is indicated by a message in the Driver Information Centre which indicates the overdue distance.  flashes and then lights up permanently until service is executed.

### Reset of service interval

After each service, the service indicator must be reset to ensure proper functionality. It is recommended to seek the assistance of a workshop.

If service is executed by yourself, operate as following:

- switch off ignition
- press and hold button  or CHECK.
- switch on ignition; the distance indication begins a countdown
- when the display indicates "=0", release the button. Symbol  disappears

### Retrieving service information

To retrieve the status of the service information at any time press button  or **CHECK**. The service information is displayed for a few seconds.

Service information ⇨ 234.

### Control indicators

The control indicators described are not present in all vehicles. The description applies to all instrument versions. Depending on the equipment, the position of the control indicators may vary. When the ignition is switched on, most control indicators will illuminate briefly as a functionality test.

The control indicator colours mean:

red	: danger, important reminder
yellow	: warning, information, fault
green	: confirmation of activation
blue	: confirmation of activation
white	: confirmation of activation

See all control indicators on different instrument clusters ⇨ 87.

## Turn signal

↔ illuminates or flashes green.

### Illuminates briefly

The parking lights are switched on.

### Flashes

A turn signal or the hazard warning flashers are activated.

Rapid flashing: failure of a turn signal light or associated fuse, failure of turn signal light on trailer.

Bulb replacement ↗ 210.

Turn signals ↗ 118.

## Seat belt reminder

### Seat belt reminder on all seats

⚠ illuminates or flashes red in the instrument cluster together with the indication in the roof console for each seat belt.



- When the ignition is switched on, ⚠ in the instrument cluster and the symbol for the respective seat in the roof console comes on, if the seat belt of any occupied seat has not been fastened.
- After running up, ⚠ in the instrument cluster and the symbol for the respective seat in the roof console flashes for a certain time together with a chime. After a certain time of driving ⚠ illuminates constantly until the seat belt of the

respective seat has been fastened or if any passenger has unfastened the seat belt.

## Airbag and belt tensioners

⚠ illuminates red.

When the ignition is switched on, the control indicator illuminates for approx. four seconds. If it does not illuminate, does not extinguish after four seconds or illuminates whilst driving, there is a fault in the airbag system. Seek the assistance of a workshop. The airbags and belt pretensioners may fail to trigger in the event of an accident.

Deployment of the belt pretensioners or airbags is indicated by continuous illumination of ⚠.

### ⚠ Warning

Have the cause of the fault remedied immediately by a workshop.

Belt pretensioners, airbag system  
↗ 52, ↗ 55.

## Airbag deactivation



 **ON** illuminates yellow.

The front passenger airbag is activated.

 **OFF** illuminates yellow.

The front passenger airbag is deactivated.

Airbag deactivation ⇨ 60.

### **Danger**

Risk of fatal injury for a child using a child restraint system together with activated front passenger airbag.

Risk of fatal injury for an adult person with deactivated front passenger airbag.

## Charging system

 illuminates red.

Illuminates when the ignition is switched on and extinguishes shortly after the engine starts.

## Illuminates when the engine is running

Stop, switch off engine. Vehicle battery is not charging. Engine cooling may be interrupted. The brake servo unit may cease to be effective. Seek the assistance of a workshop.

## Malfunction indicator light

 illuminates or flashes yellow.

Illuminates when the ignition is switched on and extinguishes shortly after the engine starts.

## Illuminates when the engine is running

Fault in the emission control system. The permitted emission limits may be exceeded. Seek the assistance of a workshop immediately.

## Flashes when the engine is running

Fault that could lead to catalytic converter damage. Ease up on the accelerator until the flashing stops. Seek the assistance of a workshop immediately.

## Stop engine

STOP illuminates red.

Illuminates briefly when the ignition is switched on.

Illuminates together with other control indicators, accompanied by a warning chime and a corresponding message in the Driver Information Centre.



Stop engine immediately and seek the assistance of a workshop.

## System check

 illuminates yellow or red.

### Illuminates yellow

A minor engine fault has been detected.

### Illuminates red

A major engine fault has been detected.

Stop engine as soon as possible and seek the assistance of a workshop.

## Brake and clutch system

 illuminates red.

The brake and clutch fluid level is too low.

### Warning

Stop. Do not continue your journey. Consult a workshop.

## Electric parking brake

 illuminates or flashes red.

### Illuminates

Electric parking brake is applied  
 151.

### Flashes

Electric parking brake is not applied automatically. The application or the release are faulty.

### Warning

Have the cause of the fault remedied immediately by a workshop.

 illuminates yellow.

### Illuminates

Automatic operation is deactivated or faulty. Activate automatic operation again or have the cause remedied by a workshop in the event of a fault.

Automatic operation  151.

## Electric parking brake fault

 illuminates yellow.

### Illuminates

Electric parking brake has a fault.  
 151.

### Warning

Have the cause of the fault remedied immediately by a workshop.

## Antilock brake system (ABS)

 illuminates yellow.

Illuminates for a few seconds after the ignition is switched on. The system is ready for operation when the control indicator extinguishes.

If the control indicator does not extinguish after a few seconds, or if it illuminates while driving, there is a fault in the ABS. The brake system remains operational but without ABS regulation.

Antilock brake system  150.

## Gear shifting

▲ with the number of a higher gear is indicated, when upshifting is recommended for fuel saving reasons.

## Lane departure warning

🚦 illuminates green or flashes yellow.

### Illuminates green

System is switched on and ready to operate.

### Flashes yellow

System recognizes an unintended lane change.

## Lane keep assist

🚦 illuminates green or yellow, or flashes yellow.

### Illuminates green

The system is switched on and ready to operate.

## Illuminates yellow

The system approaches a detected lane marking without using the turn signal in that direction.

### Flashes yellow

The system recognizes that the lane is departed significantly.

Lane keep assist ⇨ 190

## Electronic Stability Control and Traction Control system

🚦 illuminates or flashes yellow.

### Illuminates

A fault in the system is present. Continued driving is possible. Driving stability, however, may deteriorate depending on road surface conditions.

Have the cause of the fault remedied by a workshop.

## Flashes

The system is actively engaged. Engine output may be reduced and the vehicle may be braked automatically to a small degree.

Electronic Stability Control and Traction Control system ⇨ 153.

Selective ride control ⇨ 155.

## Engine coolant temperature

● illuminates red.

### Illuminates when the engine is running

Stop, switch off engine.

<b>Caution</b>
Coolant temperature too high.

Check coolant level immediately ⇨ 206.

If there is sufficient coolant, consult a workshop.

## Preheating

 illuminates yellow.

Preheating of Diesel engine is activated. Only activates when outside temperature is low. Start the engine when control indicator extinguishes.

## Diesel particle filter

 or  illuminates yellow.

The diesel particle filter requires cleaning.

Continue driving until the control indicator extinguishes. .

## Illuminates temporarily

Start of saturation of the particle filter. Start cleaning process as soon as possible by driving at a vehicle speed of at least 40 mph.

## Illuminates constantly

Indication of a low additive level. Seek the assistance of a workshop.

Diesel particle filter ↗ 142.

## AdBlue

 flashes or illuminates yellow.

### Illuminates yellow

The remaining driving range is between 600 km and 2400 km.

Have the AdBlue® topped-up as soon as possible by a qualified workshop. You can add up to 10 litres of AdBlue® to its tank.

### Flashes yellow

The remaining driving range is between 0 and 600 km.

Top-up the AdBlue® as soon as possible to avoid a breakdown by a qualified workshop. You can add up to 10 litres of AdBlue® to its tank.

## Deflation detection system

 illuminates or flashes yellow.

### Illuminates

Tyre pressure loss in one or more wheels. Stop immediately and check tyre pressure.

## Flashes

Fault in system. Consult a workshop. Deflation detection system ↗ 218.

## Engine oil pressure

 illuminates red.

Illuminates when the ignition is switched on and extinguishes shortly after the engine starts.

## Illuminates when the engine is running

Caution
<p>Engine lubrication may be interrupted. This may result in damage to the engine and/or locking of the drive wheels.</p>

1. Depress clutch.
2. Select neutral gear, set selector lever to **N**.
3. Move out of the flow of traffic as quickly as possible without impeding other vehicles.
4. Switch off ignition.

**⚠ Warning**

When the engine is off, considerably more force is needed to brake and steer. During an Autostop the brake servo unit will still be operational.

Do not remove key until vehicle is stationary, otherwise the steering wheel lock could engage unexpectedly.

Check oil level before seeking the assistance of a workshop ⇨ 205.

**Low fuel**

● illuminates yellow.

Level in fuel tank is too low.

Refuelling ⇨ 195.

Bleeding the diesel fuel system  
⇨ 209.

**Autostop**

(A) illuminates or flashes green.

**Illuminates green**

Engine is in an Autostop.

**Flashes green**

Autostop is temporarily unavailable, or Autostop mode is invoked automatically.

Stop-start system ⇨ 139.

**Exterior light**

➤⊖ illuminates green.

The exterior lights are on ⇨ 112.

**High beam**

≡⊖ illuminates blue.

Illuminates when high beam is on, during headlight flash ⇨ 113, or when high beam is on with high beam assist ⇨ 113.

**High beam assist**

≡⊖ illuminates green.

The high beam assist is activated  
⇨ 115.

**LED headlights**

➤⊖ illuminates and a warning message is displayed in the Driver Information Centre.

Seek the assistance of a workshop.

**Fog light**

⊖⊖ illuminates green.

The front fog lights are on ⇨ 119.

**Rear fog light**

⊖⊖ illuminates yellow.

The rear fog light is on ⇨ 119.

**Rain sensor**

⊖⊖ illuminates green.

Illuminated when rain sensor position on wiper stalk is selected.

**Side blind spot alert**

⊖⊖ illuminates green.

The system is active.

## Cruise control

 illuminates white or green.

### Illuminates white

The system is on.

### Illuminates green

Cruise control is active. Set speed is indicated in the Driver Information Centre.

Cruise control  158.

## Adaptive cruise control

 illuminates white or green.

 illuminates in the Driver Information Centre.

### Illuminates white

The system is on.

### Illuminates green

Adaptive cruise control is active.

When Adaptive cruise control is on or active,  with the set speed is indicated in the Driver Information Centre.



Adaptive cruise control  162.

## Vehicle detected ahead



 illuminates green.

### Illuminates green

A vehicle ahead is detected in the same lane.

Adaptive cruise control  162,  
Forward collision alert  169.

## Speed limiter

 illuminates in the Driver Information Centre when Speed limiter is active. Set speed is indicated alongside  symbol.

Speed limiter  160.

## Door open

 illuminates red.

A door or the tailgate is open.

## Information displays

### Driver Information Centre

The Driver Information Centre is located in the instrument cluster.

Driver Information Centre indicates:

- overall and trip odometer
- digital speed indication
- trip/fuel information menu
- gear shift indication
- service information
- vehicle and warning messages
- driver assistance messages
- pop-up messages

### Selecting menus and functions

The menus and functions can be selected via the buttons on the turn signal lever.



Turn the adjuster wheel to select a page in the Trip/fuel information menu.

Press **SET/CLR** to confirm or reset a function.

Vehicle and service messages are popped up in the Driver Information Centre if required. Scroll messages by turning the adjuster wheel. Confirm messages by pressing **SET/CLR**. Vehicle messages ⇨ 103.

## Trip/fuel information menu



Different pages with combined information can be selected.

Turn the adjuster wheel to select a page.

### Information page: Fuel range

Range is calculated from current fuel level and current consumption. The display shows average values.

After refuelling, the range is updated automatically after a brief delay.

When the level in the fuel tank is low, a message appears on the display and the control indicator ● in the fuel gauge illuminates ⇨ 98.

### Instantaneous Fuel Consumption

Display of the instantaneous consumption.

### Trip 1 page:

#### Average speed

Display of average speed. The measurement can be reset at any time.

#### Average fuel consumption

Display of average consumption. The measurement can be reset at any time and starts with a default value.

#### Distance travelled

Displays the current distance for trip 1 since the reset.

The values of trip 1 page can be reset by pressing **SET/CLR** for a few seconds.

### Trip 2 page:

#### Average speed

Display of average speed. The measurement can be reset at any time.

### Average fuel consumption

Display of average consumption. The measurement can be reset at any time and starts with a default value.

### Distance travelled

Displays the current distance for trip 2 since a certain reset.

The values of trip 2 page can be reset by pressing **SET/CLR** for a few seconds.

### Digital speed page

Digital display of the instantaneous speed.

### Stop and Start time counter

A time counter calculates the time spent in STOP mode during a journey. It resets to zero every time the ignition is switched on.

### Compass page

Displays the geographic direction of driving.

### Blank page

No trip/fuel information is displayed.

### Info display

The Info-Display is located in the instrument panel near the instrument cluster.

Depending on the vehicle configuration the vehicle has a

- **Graphic-Info-Display**  
or
- **7" Colour-Info-Display** with touchscreen functionality  
or
- **8" Colour-Info-Display** with touchscreen functionality

The Info displays can indicate:

- time ↷ 83
- outside temperature ↷ 82
- date ↷ 83
- Infotainment system, see description in the Infotainment manual
- indication of rear view camera ↷ 187

- indication of panoramic view system ↷ 184
- indication of parking assist instructions ↷ 174
- navigation, see description in the Infotainment manual
- vehicle and system messages ↷ 103
- settings for vehicle personalisation ↷ 104

### Graphic-Info-Display



Press **⏻** to switch on the display.

Press **MENU** to select main menu page.

Press **<Δ∇>** to select a menu page.

Press **OK** to confirm a selection.

Press **BACK** to exit a menu without changing a setting.

### 7" Colour-Info-Display

#### Selecting menus and settings

Menus and settings are accessed via the display.



Press **⏻** to switch on the display.

Press **🏠** to display the homepage.

Touch required menu display icon with the finger.

Touch a respective icon to confirm a selection.

Touch **↶** to return to the next higher menu level.

Press **🏠** to return to the homepage.

For further information, see Infotainment manual.

Vehicle personalisation **↷** 104.

### 8" Colour-Info-Display

#### Selecting menus and settings

There are three options to operate the display:

- via buttons below the display
- by touching the touchscreen with the finger
- via speech recognition

### Button and touch operation



Press **⏻** to switch on the display.

Press **SET** to select system settings (units, language, time and date).

Press **🚗** to select vehicle settings or driving functions.

Touch required menu display icon or a function with the finger.

Confirm a required function or selection by touching.

Touch **↶** on the display to exit a menu without changing a setting.

For further information, see Infotainment manual.



**Speech recognition**

Description see Infotainment manual.

Vehicle personalisation ⇨ 104.

## Vehicle messages

Messages are indicated in the Driver Information Centre, in some cases together with a warning and signal chime.



Press **SET/CLR** on the turn signal lever to confirm a message.

### Vehicle and service messages

The vehicle messages are displayed as text. Follow the instructions given in the messages.

### Messages in the Colour-Info-Display

Some important messages may appear additionally in the Info-Display. Some messages only pop-up for a few seconds.

### Warning chimes

#### When starting the engine or whilst driving

Only one warning chime will sound at a time.

The warning chime regarding not fastened seat belts has priority over any other warning chime.

- If a seat belt is not fastened.
- If a door or the tailgate is not fully closed when starting off.
- If a certain speed is exceeded with parking brake applied.
- If cruise control deactivates automatically.
- If a programmed speed or speed limit is exceeded.

- If a warning message appears in the Driver Information Centre.
- If the electronic key is not in the passenger compartment.
- If the parking assist detects an object.
- If an unintended lane change occurs.
- If the diesel particle filter has reached the maximum filling level.

### When the vehicle is parked and/or the driver's door is opened

- With exterior lights on.

### During an Autostop

- If the driver's door is opened.
- If any condition for an autostart is not fulfilled.

### Battery voltage

When the vehicle battery voltage is running low, a warning message will appear in the Driver Information Centre.

When the vehicle is being driven, the load reduction function temporarily deactivates certain functions, such as the air conditioning, the heated rear screen, heated steering wheel, etc.

The deactivated functions are reactivated automatically as soon as conditions permit.

## Vehicle personalisation

The vehicle's behaviour can be personalised by changing the settings in the Info-Display.

Depending on vehicle equipment and country-specific regulations some of the functions described below may not be available.

Some functions are only displayed or active when the engine is running.

### Graphic-Info-Display

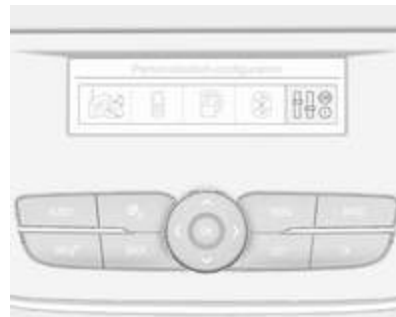

Press **MENU** to open the menu page.

Use four-way button to operate the display:

Select  **Personalisation-configuration**,  **OK**.

#### Unit settings

Select **Display configuration**,  **OK**.

Select **Choice of units**,  **OK**.

Select desired settings,  **OK**.

#### Language settings

Select **Display configuration**,  **OK**.

Select **Choice of language**,  **OK**.

Select desired language,  **OK**.

#### Vehicle settings

Select **Define vehicle parameters**,  **OK**.

In the corresponding submenus the following settings can be changed:

- **Lighting.**

**Follow me home headlamps:**

Activation and setting duration time.

**Welcome lighting:** Activation and setting duration time.

- **Comfort**

**Ambient lighting:** Activation/Deactivation.

**Rear wiper in reverse gear:** Activation/Deactivation.

- **Vehicle**

**Unlocking boot only:** Activation/Deactivation.

**Plip action:** Driver/all doors.

- **Driving assistance**

**Fatigue Detection system:** Activation/Deactivation.

**Speed recommendation:** Activation/Deactivation.

### 7" Colour-Info-Display



Press  to open homepage.

Use touch buttons to operate the display:

Select **Settings**.

#### Unit settings

Select **Units**

Change units for **Consumption and Distance** and **Temperature**.

Touch  repeatedly to return to the homepage.

#### Language settings

Select **Language**.

Change language by touching the respective entry.

Touch  repeatedly to return to the homepage.

#### Vehicle settings

Select **Vehicle**.

In the corresponding submenus the following settings can be changed:

- **Collision / Detection Systems**

**Side Blind Spot Alert:** Activates or deactivates side blind spot alert.

**Drowsy Driver Alert:** Activates or deactivates the driver drowsiness system.

**Speed Limit Information:**

Activates or deactivates the speed limit information by traffic sign recognition.

**Rear View Camera Guidelines:**

Activates or deactivates the rear view camera guidelines on the Info display.

**Forward Collision Alert:** Activates or deactivates the forward collision alert, adjusts the alert sensitivity.

- **Comfort and Convenience**

**Auto Wipe in Reverse Gear:**

Activates or deactivates automatic switching on of the rear window wiper when reverse gear is engaged.

- **Lighting**

**Ambient Lighting:** Activates or deactivates the ambient lighting and adjusts its brightness.

**Welcome Lighting:** Activates or deactivates and changes the duration of welcome lighting.

**Exit Lighting:** Activates or deactivates and changes the duration of exit lighting.

- **Remote Lock, Unlock, Start**

**Remote Door Unlock:** Changes the configuration to unlock the driver's door only or all doors when pressing  on the remote control.

**Unlock boot only:** Activates or deactivates unlocking the tailgate only when pressing  on the remote control.

Touch  repeatedly to return to the homepage.

## 8" Colour-Info-Display



Press **SET** to open settings menu.

Use touch buttons to operate the display.

### Unit settings

Select **System settings**.

Change units for **Consumption and Distance** and **Temperature**.

Confirm with 

Touch  repeatedly to exit the menu.

### Language settings

Select **Languages**.

Change language by touching the respective entry.

Confirm with ✓

Touch ← repeatedly to exit the menu.

### Vehicle settings



Press .

Select **Vehicle settings**.

In the corresponding submenus the following settings can be changed:

- **Vehicle access**

- **Door unlock: Driver only:**

- Changes the configuration to unlock the driver's door only or all

doors when pressing  on the remote control.

**Door unlock: Boot only:** Activates or deactivates unlocking the tailgate only when pressing  on the remote control.

**Motorised tailgate/door:**

Activates or deactivates the opening or closing of the motorised tailgate/door.

**Hands-free tailgate access:**

Activates or deactivates the function.

- **Safety**

- **Recommended speed display:**

- Activates or deactivates the speed limit information by traffic sign recognition.

- **Active safety brake:** Activates or deactivates active emergency braking, the alert sensitivity can be selected.

- **Mirror adaptation:**

- **Driver attention warning:**

- Activates or deactivates the driver drowsiness system.

**Rear wiper in reverse:** Activates or deactivates automatic switching on of the rear window wiper when reverse gear is engaged.

- **Driving lighting**

- **Directional headlamps:** Activates or deactivates the function.

- **Comfort lighting**

- **Guide-me-home lighting:**

- Activates or deactivates the function and adjusts its duration.

- **Welcome lighting:** Activates or deactivates the function and adjusts its duration.

- **Mood lighting:** Adjusts the brightness of the ambient lighting.

## Driving functions



Press .

Select **Driving functions**.

In the corresponding submenus the following settings can be changed:

- **Park Assist:** Activates advanced park assist, a parking maneuver can be selected.
- **Blind Spot Sensors:** Activates or deactivates side blind spot alert.
- **Panoramic view system:** Activation/deactivation of the function.

## Telematics service

## OnStar

OnStar is a personal connectivity and service assistant with integrated Wi-Fi hotspot. The OnStar service is available 24 hours a day, seven days a week.

**Notice**

OnStar is not available for all markets. For further information, contact your workshop.

**Notice**

In order to be available and operational, OnStar needs a valid OnStar subscription, functioning vehicle electrics, ignition on, mobile service and GPS satellite link.

To activate the OnStar services and set up an account, press  and speak with an advisor.

Depending on the equipment of the vehicle, the following services are available:

- Emergency services and support in the case of a vehicle breakdown
- Wi-Fi hotspot
- Smartphone application
- Remote control, e.g. location of the vehicle, activation of horn and lights, control of central locking system
- Stolen vehicle assistance
- Vehicle diagnostics

**Notice**

The OnStar module of the vehicle is deactivated after ten days without an ignition cycle. Functions requiring a data connection will be available again after switching on the ignition.

## OnStar buttons



### Privacy button

Press and hold  until a message is heard to activate or deactivate the transmission of the vehicle location.

Press  to answer a call or to end a call to an advisor.

Press  to access the Wi-Fi settings.

### Service button

Press  to establish a connection to an advisor.

### SOS button

Press  to establish a priority emergency connection to a specially trained emergency advisor.

### Status LED

Green: The system is ready with activated transmission of the vehicle location.

Green flashing: The system is on a call.

Red: A problem arose.

Off: The system is ready with deactivated transmission of the vehicle location or the system is in standby mode.

Red / green flashing for a short period of time: The transmission of the vehicle location has been deactivated.

## OnStar services

### General services

If you need any information e.g. opening hours, points of interest and destinations or if you need any support e.g. in the case of a vehicle

breakdown, a flat tyre and empty fuel tank, press  to establish a connection to an advisor.

### Emergency services

In the case of an emergency situation, press  and talk to an advisor. The advisor then contacts emergency or assistance service providers and directs them to your vehicle.

In the case of an accident with activation of airbags or belt tensioners, an automatic emergency call is established. The advisor is immediately connected to your vehicle to see whether help is needed.

### Notice

Establishing an emergency call may not be possible in areas without sufficient network availability or due to hardware damage during an accident.

### Wi-Fi hotspot

The Wi-Fi hotspot of the vehicle provides internet connectivity with a maximum speed of 4G/LTE.

### Notice

The Wi-Fi hotspot functionality is not available for all markets.

Up to seven devices may be connected.

To connect a mobile device with the Wi-Fi hotspot:

1. Press  and then select Wi-Fi settings on the Info-Display. The settings displayed include the Wi-Fi hotspot name (SSID), password and connection type.
2. Start a Wi-Fi network search on your mobile device.
3. Select your vehicle hotspot (SSID) when listed.
4. When prompted, enter the password on your mobile device.

### Notice

To change the SSID or password, press  and talk to an advisor or log in to your account.

To switch off the Wi-Fi hotspot functionality, press  to call an advisor.

### Smartphone app

With the My Vauxhall smartphone app, some vehicle functions can be operated remotely.

The following functions are available:

- Lock or unlock vehicle.
- Honk horn or flash lights.
- Check fuel level.
- Locate vehicle on a map.
- Manage Wi-Fi settings.

To operate these functions, download the app from App Store® or Google Play™ Store.

### Remote control

If desired, use any phone to call an advisor, who can remotely operate specific vehicle functions. Find the respective OnStar phone number on our country-specific website.

The following functions are available:

- Lock or unlock vehicle.
- Provide information on the vehicle location.
- Honk horn or flash lights.

### Stolen vehicle assistance

If the vehicle is stolen, report the theft to the authorities and request OnStar stolen vehicle assistance. Use any phone to call an advisor. Find the respective OnStar phone number on our country-specific website.

OnStar can provide support in locating and recovering the vehicle.

### Theft alert

When the anti-theft alarm system is triggered, a notification is sent to OnStar. You are then informed about this event by text message or email.

### Restart prevention

By sending remote signals, OnStar can prevent the vehicle from restarting once it has been turned off.

### On-demand diagnostics

At any time e.g. if the vehicle displays a vehicle message, press  to contact an advisor and ask to complete a real-time diagnostic check to directly determine the issue. Depending on the results, the advisor will provide further support.



### Diagnostic report

The vehicle automatically transmits diagnostic data to OnStar which sends a monthly email report to you and your preferred workshop.

#### Notice

The workshop notification function can be disabled in your account.

The report contains the status of key operating systems of the vehicle like engine, transmission, airbags, ABS, and other major systems. It also provides information on possible maintenance items and tyre pressure (only with tyre pressure monitoring system).

To look at the information in greater detail, select the link within the email and log in to your account.

### OnStar settings

#### OnStar PIN

To have full access to all OnStar services, a four-digit PIN is required. The PIN has to be personalised when first talking to an advisor.

To change the PIN, press  to call an advisor.

### Account data

An OnStar subscriber has an account where all the data is stored. To request a change of the account information, press  and talk to an advisor or log in to your account.

If the OnStar service is used on another vehicle, press  and request that the account be transferred to the new vehicle.

#### Notice

In any case, if the vehicle is disposed of, sold or otherwise transferred, immediately inform OnStar about the changes and terminate the OnStar service on this vehicle.

### Vehicle location

The vehicle location is transmitted to OnStar when service is requested or triggered. A message on the Info-Display informs about this transmission.

To activate or deactivate the transmission of the vehicle location, press and hold  until an audio message is heard.

The deactivation is indicated by the status light flashing red and green for a short period of time and each time the vehicle is started.

#### Notice

If the transmission of the vehicle location is deactivated, some services are no longer available.

#### Notice

The vehicle location always remains accessible to OnStar in the case of an emergency.

Find the privacy policy in your account.

### Software updates

OnStar may remotely carry out software updates without further notice or consent. These updates are to enhance or maintain safety and security or the operation of the vehicle.

These updates may concern privacy issues. Find the privacy policy in your account.

# Lighting

## Exterior lighting

### Light switch



Turn light switch:

**AUTO** : automatic light control switches automatically between daytime running light and headlight

 : sidelights

 : headlights

When switching on the ignition, automatic light control is active.

Control indicator   98.

## Tail lights

Tail lights are illuminated together with low/high beam and sidelights.

### Automatic light control



When the automatic light control function is switched on and the engine is running, the system switches between daytime running lights and headlights automatically depending on the external lighting conditions and information given by the rain sensor system.

Daytime running light  115.

## Automatic headlight activation

During poor lighting conditions the headlights are switched on.

Additionally, headlights are switched on if the windscreen wipers have been activated for several wipes.

## Tunnel detection

When a tunnel is entered, headlights are switched on immediately.

## High beam



Push lever to switch from low to high beam.

Pull lever to deactivate high beam.

High beam assist ⇨ 115.

## High beam assist

Description for version with halogen headlights. High beam assist with LED headlights ⇨ 115.

This feature allows high beam to function as the main driving light at night and when vehicle speed exceeds 15 mph.

It switches automatically to low beam when:

- The camera or a sensor in the windscreen detects the lights of oncoming or preceding vehicles.
- The vehicle speed drops below 9 mph.
- It is foggy or snowy.
- Driving in urban areas.

If there are no restrictions detected, the system switches back to high beam.



## Activation



The high beam assist can only be activated with the light switch in position **AUTO**.



Activate the high beam assist by pressing  on the turn and lane change lever. The LED of the button illuminates if the high beam assist is activated. High beam is switched on automatically at a speed above 15 mph.

The green control indicator  illuminates continuously when the assist is activated, the blue one  illuminates when high beam is on.

Control indicator   98.

### Deactivation

Deactivate the high beam assist by pressing  on the turn and lane change lever

If a headlight flash is activated when the high beam assist is activated and low beam is on, the high beam assist will be deactivated. The system changes to high beam.

If a headlight flash is activated when the high beam assist is activated and high beam is on, the high beam assist will be deactivated. The system changes to low beam.

To reactivate the high beam assist, flash the headlights again.

### Headlight flash



To activate the headlight flash, pull lever.

Pulling lever deactivates high beam.

### Headlight range adjustment

#### Manual headlight range adjustment



To adapt headlight range to the vehicle load to prevent dazzling: turn thumb wheel  to required position.

- 0 : front seats occupied
- 1 : all seats occupied
- 2 : all seats occupied and load compartment laden
- 3 : driver's seat occupied and load compartment laden

## Daytime running lights

Daytime running light increases visibility of the vehicle during daylight.

They are switched on automatically when the engine is running.

The system switches between daytime running lights and low beam automatically, depending on the lighting conditions.

## LED headlights

### ⚠ Warning

Do not look directly into the LED lights to avoid damage to your eyes.

LED headlight system contains a variety of particular LEDs in each headlight which enables the control of the Adaptive forward lighting functions.

Light distribution and intensity of light are variably triggered depending on the lighting conditions, road type and driving situation. The vehicle adapts

the headlights automatically to the situation to enable optimal light performance for the driver.

Some Adaptive forward lighting functions of the LED headlights can be deactivated or activated in the vehicle personalisation menu. Select the relevant setting in **Settings**, **Vehicle** in the Info-Display. Vehicle personalisation ↪ 104.

The lighting functions are only available with light switch in position **AUTO**.

## Country light



Activated automatically at a speed between 34 mph and 71 mph when driving in rural areas. The illumination of the current lane and the side of the road is improved. Oncoming and preceding vehicles are not dazzled.

## Motorway light



Activated automatically at a speed above 71 mph. Illumination is adapted to the higher speed driven on motorways. If there is no oncoming traffic, the visibility on the side of the vehicle is increased. The visibility range raises from 70 m to 140 m allowing distant objects to be recognised across the entire width of the road.

## Town light



Activated automatically at a speed up to approx. 34 mph and in situations with exterior ambient light. The light is

wide and symmetrical. If the speed is below 19 mph, the headlamps are slightly swiveled to the outside to allow an earlier recognition of pedestrians and objects on each side of the road. A special beam pattern is designed to avoid glare for other road users.

### Corner light



When turning off, depending on the steering angle and the turn signal light, particular LEDs are triggered which illuminate the direction of travel. It is activated up to a speed of 25 mph.

### Adverse weather light



Controlled by wiper or rain sensor and activated at rain and snowfall. The wide light distribution – slightly swiveled to the outside – enables improved orientation at the edge of the road. The intensity of the light in the far distance is increased in order to recognize objects and markings on the right road side and obstacles on the lane despite the weather condition. Lowering the reflection on wet roads reduces dazzling of oncoming traffic. Adverse weather light is activated up to a speed to 43 mph.

### Curve light



Particular LEDs, based on steering angle and speed, are additionally triggered to improve lighting in curves. This function is activated at speeds from 25 mph to 43 mph and reacts to steering angle.

### High beam assist

This feature allows the high beam to function as main driving light at night.

The camera in the windscreen detects the lights of oncoming or preceding vehicles. Each LED on right or left side can be triggered or faded out particularly according to the traffic situation. This gives the best light distribution without dazzling other road users. Once activated, high beam assist remains active and switches high beam on and off depending on surrounding

conditions. The latest setting of the high beam assist will remain after the ignition is switched on again.





High beam assist includes a special motorway mode. When driving faster than 71 mph on motorways, the light beam becomes smaller to avoid dazzling of oncoming traffic. When following vehicles ahead or passing, mirror dazzling for these vehicles is reduced.

### Activation



Activate the high beam assist by pressing  on the turn and lane change lever. The LED of the button illuminates if the high beam assist is activated. High beam is switched on automatically at a speed above 15 mph. High beam is switched off at a speed below 9 mph, but high beam assist remains active.

The green control indicator  illuminates continuously when the high beam assist is activated, the blue one  illuminates when high beam is on.

Control indicator   98,   98.

Pressing indicator lever once switches on manual high beam without high beam assist.

High beam assist switches automatically to low beam when:

- Driving in urban areas.
- Camera detects heavy fog.
- Front or rear fog lights are switched on.

If there are no restrictions detected, the system switches back to high beam.

### Deactivation

Deactivate the high beam assist by pressing  on the turn and lane change lever

If a headlight flash is activated when the high beam assist is activated and low beam is on, the high beam assist will be deactivated. The system changes to high beam.

If a headlight flash is activated when the high beam assist is activated and high beam is on, the high beam assist will be deactivated. The system changes to low beam.

To reactivate the high beam assist, flash the headlights again.

### Fault in LED headlight system

When the system detects a failure in the LED headlight system, it selects a preset position to avoid dazzling of oncoming traffic. A warning is displayed in the Driver Information Centre.

### Hazard warning flashers



Operated by pressing .

When braking in an emergency, the hazard warning flashers are switched on automatically depending on the

force of deceleration. They are switched off automatically the first time you accelerate.

### Turn and lane-change signals



lever up : right turn signal

lever down : left turn signal

A resistance point can be felt when moving the lever.

Constant flashing is activated when the lever is being moved beyond the resistance point. It is deactivated when the steering wheel is moved in

the opposite direction or lever is manually moved back to its neutral position.

Activate temporary flashing by holding the lever just before the resistance point. Turning lights will flash until lever is being released.

To activate three flashes, tap the lever briefly without passing the resistance point.

If you forget to cancel the turn and lane-change signals for more than twenty seconds, the volume of the audible signal will increase if the speed is above 40 mph.



## Front fog lights



Operated by pressing **D**.

Light switch in position **AUTO**: switching on front fog lights will switch headlights on automatically.

## Rear fog light



Operated by pressing **D**.

Light switch in position **AUTO**: switching on rear fog light will switch headlights on automatically.

Light switch in position **☞☛**: rear fog light can only be switched on with front fog lights.

The vehicle rear fog light is deactivated when towing a trailer or a plug is connected with the socket, e. g. when a bicycle carrier is used.

## Parking lights



When the vehicle is parked, the parking lights on one side can be activated:

1. Switch off ignition.
2. Move turn signal lever all the way up (right parking lights) or down (left parking lights).

Confirmed by a signal and the corresponding turn signal indicator.

## Reversing lights

The reversing light comes on when the ignition is on and reverse gear is selected.

## Misted light covers

The inside of the light housing may mist up briefly in poor, wet and cold weather conditions, in heavy rain or after washing. The mist disappears quickly by itself; to help switch on the headlights.

## Interior lighting

### Instrument panel illumination control



Brightness of the following lights can be adjusted when the exterior lights are on:

- instrument panel illumination
- Info-Display
- illuminated switches and operation elements

Turn thumb wheel  and hold until the desired brightness is obtained.

## Interior lights

During entry and exit of the vehicle, the front and rear courtesy lights automatically switch on and then off after a delay.

### Notice

In the event of an accident with airbag deployment the courtesy lights are turned on automatically.

## Front courtesy light



Operate rocker switch:

 : automatic switching on and off

press  : on

press  : off

## Rear courtesy lights

Illuminate in conjunction with the front courtesy light depending on rocker switch position.

## Reading lights





Operated by pressing  and  in the courtesy lights.



Illustration shows rear courtesy lights.

## Sunvisor lights

Illuminates when the cover is opened.

## Lighting features

### Centre console lighting

A spotlight integrated in the overhead console illuminates the centre console when headlights are switched off.

### Entry lighting

#### Welcome lighting

Some or all of the following lights are switched on for a short time by unlocking the vehicle with the radio remote control:

- headlights
- rear view mirror lights
- interior lights

The number of activated lights depends on the surrounding light conditions.

The lighting switches off immediately when the ignition is switched on. Starting off  17.

This function can be activated or deactivated in the vehicle personalisation.

Vehicle personalisation ⇨ 104.

The following lights will additionally switch on when the driver's door is opened:

- illumination of some switches
- Driver Information Centre
- door pocket lights

### Exit lighting

The following lights are switched on if the ignition is switched off:

- headlights
- interior lights
- instrument panel light

They will switch off automatically after a delay. This function works only in the dark. Theatre lighting is activated if the driver's door is opened during this time.

### Battery discharge protection

To prevent discharge of the vehicle battery when the ignition is switched off, some interior lights are switched off automatically after some time.

## Climate control

<b>Climate control systems</b> .....	<b>123</b>
Heating and ventilation system	123
Air conditioning system .....	124
Electronic climate control system .....	126
Auxiliary heater .....	131
<b>Air vents</b> .....	<b>131</b>
Adjustable air vents .....	131
Fixed air vents .....	132
Glovebox cooler .....	132
<b>Maintenance</b> .....	<b>132</b>
Air intake .....	132
Pollen filter .....	132
Air conditioning regular operation .....	132
Service .....	132

## Climate control systems

### Heating and ventilation system



Controls for:

- temperature ↵ ↶
- air distribution 🌀, 🌀 and 🌀
- fan speed ⚙️
- demisting and defrosting 🧊
- heated rear window and exterior mirrors 🪞<sub>REAR</sub>
- heated seats 🪑

Heated rear window 🪞<sub>REAR</sub> ⇨ 41.

Exterior mirrors 🪞 ⇨ 39.

Heated seats 🪑 ⇨ 50.

### Temperature

Adjust the temperature by turning ↵ ↶ to the desired temperature.

red area : warmer  
blue area : colder

Heating will not be fully effective until the engine has reached normal operating temperature.

### Air distribution

- 🌀 : to windscreen and front door windows
- 🌀 : to head area via adjustable air vents
- 🌀 : to foot well and windscreen

All combinations are possible.





### Fan speed

Adjust the air flow by turning ⚙️ to the desired speed.

to the right : increase  
to the left : decrease

## Demisting and defrosting











- Press : the air distribution is directed towards the windscreen.
- Set temperature controller  to warmest level.
- Set fan speed  to highest level.
- Switch on heated rear window .
- Open side air vents as required and direct them towards the door windows.

## Air conditioning system



Controls for:

- temperature 
- air distribution 
- fan speed 
- demisting and defrosting 
- air conditioning **A/C**
- air recirculation 
- heated rear window and exterior mirrors 
- heated windscreen 
- heated seats 

Heated rear window  41.

Heated exterior mirrors  39.

Heated windscreen  42.

Heated seats  50.



Some setting changes are indicated briefly in the Info-Display. Activated functions are indicated by the LED in the respective button.



## Temperature

Adjust the temperature by turning  to the desired temperature.

red area : warmer  
blue area : colder

Heating will not be fully effective until the engine has reached normal operating temperature.

### Air distribution

-  : to windscreen and front door windows
-  : to head area via adjustable air vents
-  : to foot well and windscreen

All combinations are possible.

### Fan speed

Adjust the air flow by turning  to the desired speed.

- to the right : increase
- to the left : decrease

### Air conditioning A/C



Press **A/C** to switch on cooling. The LED in the button illuminates to indicate activation. Cooling is only functional when the engine is running and climate control fan is switched on.

Press **A/C** again to switch off cooling.

The air conditioning system cools and dehumidifies (dries) as soon as the outside temperature is slightly above the freezing point. Therefore, condensation may form and drip from under the vehicle.

If no cooling or drying is required, switch off the cooling system for fuel saving reasons.

Activated cooling may inhibit Autostops. Stop-start system  139.

### Air recirculation system



Press  to activate air recirculation mode. The LED in the button illuminates to indicate activation.

Press  again to deactivate air recirculation mode.

#### Warning

The exchange of fresh air is reduced in air recirculation mode. In operation without cooling the air humidity increases, so the





windows may mist up from inside. The quality of the passenger compartment air deteriorates, which may cause the vehicle occupants to feel drowsy.

In warm and very humid ambient air conditions, the windscreen may mist up from outside when cold air is directed towards it. If windscreen mists up from outside, activate windscreen wiper and deactivate .

### Maximum cooling







Briefly open the windows so that hot air can disperse quickly.

- Switch on cooling **A/C**.
- Press  for air recirculation system on.
- Press  for air distribution.
- Set temperature control  to coldest level.
- Set fan speed  to highest level.
- Open all vents.



### Demisting and defrosting the windows



- Press : the air distribution is directed towards the windscreen.
- Set temperature controller  to warmest level.

- Switch on air conditioning **A/C**, if required.
- Set fan speed  to highest level.
- Switch on heated rear window .
- Switch on heated windscreen .
- Open side air vents as required and direct them towards the door windows.

### Notice

If  is pressed while the engine is running, an Autostop will be inhibited until  is pressed again.

If  is pressed while the engine is in an Autostop, the engine will restart automatically.

Stop-start system  139.

### Electronic climate control system

The dual zone climate control allows different temperatures for driver side and front passenger side.

In automatic mode, temperature, fan speed and air distribution are regulated automatically.





Controls for:

- temperature on driver side ( / \ )
- **MENU** enters the Climate setting menu in the Info-Display
- fan speed ⌘
- automatic mode **AUTO**
- temperature on front passenger side ( / \ )
- cooling **A/C**
- manual air recirculation
- demisting and defrosting
- heated rear window and exterior mirrors
- heated windscreen

- heated seats
- ventilated seats

Heated rear window ⇨ 41.

Heated exterior mirrors ⇨ 39.

Heated seats ⇨ 50.

Ventilated seats ⇨ 51.

Activated functions are indicated by the LED in the respective control.

The electronic climate control system is only fully operational when the engine is running.

### Climate settings menu (MENU button)



Settings for

- air distribution
- fan speed ⌘
- temperature for driver and passenger side **19°/21°**
- dual zone temperature synchronisation **MONO**
- air conditioning **ON/OFF**
- automatic mode **AUTO**

can be triggered manually in the Climate setting menu. Press **MENU** to enter the menu and follow the touch buttons.

Climate setting menu can also be displayed

- by selecting **Climate** on the 7" Colour-Info-Display or
- by pressing and then selecting **Climate** from the menu on the 8" Colour-Info-Display.

## Automatic mode AUTO



Basic setting for maximum comfort:

- Press **AUTO**, the air distribution and fan speed are regulated automatically.
- Open all air vents to allow optimised air distribution in automatic mode.

- Air conditioning must be activated for optimal cooling and demisting. Press **A/C** to switch on air conditioning. The LED in the button indicates activation.
- Set the preselected temperatures for driver and front passenger using the left and right rotary knob. Recommended temperature is 22 °C.

## Manual settings

Climate control system settings can be changed by activating the following functions:

### Fan speed



Adjust the air flow by turning rotary knob to the desired speed. Turn left to decrease or turn right to increase. Fan speed can also be changed by touch buttons in the climate settings display. Press **MENU** to enter the menu.

Turn rotary knob anticlockwise: fan and cooling are switched off.



To return to automatic mode, press **AUTO**.

### Air distribution



Press **MENU** to enter the menu.

Touch in the Colour-Info-Display:

-  : to windscreen and front door windows
-  : to head area and rear seats via adjustable air vents
-  : to front and rear foot well and windscreen

To return to automatic air distribution, press **AUTO**.

### Temperature preselection / \



Set the preselected temperatures separately for the driver and the front passenger to the desired value using the left and right rotary knobs. The rotary knob on the passenger side

changes the temperature of the passenger side. The rotary knob on the driver's side changes the temperature of the driver's side or of both sides, depending on activation of synchronisation **MONO** in the climate settings menu. Press **MENU** to enter the menu.

Recommended temperature is 22 °C. Temperature is indicated in displays beside the rotary knobs and in the climate settings menu.

If the minimum temperature **Lo** is set, the climate control system runs at maximum cooling, if cooling **A/C** is switched on.

If the maximum temperature **Hi** is set, the climate control system runs at maximum heating.

#### Notice

If **A/C** is switched on, reducing the set cabin temperature can cause the engine to restart from an Autostop or inhibit an Autostop.

Stop-start system ⇨ 139.

### Dual zone temperature synchronisation **MONO** or **SYNC**

Press **MENU** to enter the menu. Touch **MONO** or **SYNC** to link passenger side temperature setting to the driver side.

When passenger side control dial will be adjusted, synchronisation is deactivated.

### Air conditioning **A/C**



Press **A/C** to switch on cooling. The LED in the button illuminates to indicate activation. Cooling is only functional when the engine is running and climate control fan is switched on.

Press **A/C** again to switch off cooling. The air conditioning system cools and dehumidifies (dries) when outside temperature is above a specific level. Therefore condensation may form and drip from under the vehicle.

If no cooling or drying is required, switch off the cooling system for fuel saving reasons.

#### Manual air recirculation



Press  to activate the air recirculation mode. The LED in the button illuminates to indicate activation.

Press  again to deactivate recirculation mode.





#### Warning

The exchange of fresh air is reduced in air recirculation mode. In operation without cooling, the air humidity increases, so the windows may mist up from inside. The quality of the passenger compartment air deteriorates, which may cause the occupants to feel drowsy.



In warm and very humid ambient air conditions, the windscreen may mist up from outside, when cold air is directed towards it. If windscreen mists up from outside, activate windscreen wiper and deactivate .

#### Demisting and defrosting the windows



- Press . The LED in the button illuminates to indicate activation.
- Temperature and air distribution are set automatically and the fan runs at high speed.
- Switch on air conditioning by pressing **A/C**, if required.
- Switch on heated rear window .
- Switch on heated windscreen .
- To return to previous mode, press  again. To return to automatic mode, press **AUTO**.

### Notice

If  is pressed while the engine is running, an Autostop will be inhibited until  is pressed again.

If  is pressed while the engine is in an Autostop, the engine will restart automatically.

Stop-start system ⇨ 139.

### Deactivation of Electronic climate control system

Cooling, fan and automatic mode can be switched off by turning rotary knob **AUTO** anticlockwise.

Activation by switching on the fan or pressing **AUTO**.

## Auxiliary heater

### Air heater

Quickheat is an electric auxiliary air heater which automatically warms up the passenger compartment more quickly.

## Air vents

### Adjustable air vents

#### Centre air vents in the instrument panel



Direct the flow of air by tilting and swivelling the slats.

To close the vent, swivel the slats inwards.

#### Outer air vents in the instrument panel



Direct the flow of air by tilting and swivelling the slats.

To close the vent, swivel the slats outwards.

At least two air vents must be open while cooling is on.

### Warning

Do not attach any objects to the slats of the air vents. Risk of damage and injury in case of an accident.

## Fixed air vents

Additional air vents are located beneath the windscreen and door windows and in the foot wells.

## Glovebox cooler

The air conditioning system can also keep the contents of the glovebox cool.



Move the slider back and forth in order to enable or disable glovebox cooling.

## Maintenance

### Air intake



The air intake in front of the windscreen in the engine compartment must be kept clear to allow air intake. Remove any leaves, dirt or snow.

### Pollen filter

The pollen filter cleans dust, soot, pollen and spores from the air entering the vehicle through the air intake.

## Air conditioning regular operation

In order to ensure continuously efficient performance, cooling must be operated for a few minutes once a month, irrespective of the weather and time of year. Operation with cooling is not possible when the outside temperature is too low.

## Service

For optimal cooling performance, it is recommended to annually check the climate control system, starting three years after initial vehicle registration, including:

- functionality and pressure test
- heating functionality
- leakage check
- check of drive belts
- cleaning of condenser and evaporator drainage
- performance check

# Driving and operating

<b>Driving hints</b> .....	<b>134</b>	<b>Manual transmission</b> .....	<b>149</b>	Refuelling .....	195
Control of the vehicle .....	134	<b>Brakes</b> .....	<b>150</b>	Fuel consumption - CO <sub>2</sub> -	
Steering .....	134	Antilock brake system .....	150	Emissions .....	196
<b>Starting and operating</b> .....	<b>134</b>	Parking brake .....	151	<b>Trailer hitch</b> .....	<b>197</b>
New vehicle running-in .....	134	Brake assist .....	153	General information .....	197
Ignition switch positions .....	134	Hill start assist .....	153	Driving characteristics and	
Power button .....	135	<b>Ride control systems</b> .....	<b>153</b>	towing tips .....	197
Power saving mode .....	136	Electronic Stability Control and		Trailer towing .....	197
Starting the engine .....	137	Traction Control system .....	153	Towing equipment .....	198
Overrun cut-off .....	138	Selective ride control .....	155	Trailer stability assist .....	200
Stop-start system .....	139	Sport mode .....	157		
Parking .....	141	<b>Driver assistance systems</b> .....	<b>158</b>		
<b>Engine exhaust</b> .....	<b>142</b>	Cruise control .....	158		
Diesel particle filter .....	142	Speed limiter .....	160		
Catalytic converter .....	143	Adaptive cruise control .....	162		
AdBlue .....	143	Forward collision alert .....	169		
<b>Automatic transmission</b> .....	<b>146</b>	Active emergency braking .....	170		
Transmission display .....	146	Front pedestrian protection .....	173		
Selector lever .....	147	Parking assist .....	174		
Manual mode .....	148	Advanced parking assist .....	177		
Electronic driving programmes	148	Side blind spot alert .....	182		
Fault .....	148	Panoramic view system .....	184		
Interruption of power supply ....	149	Rear view camera .....	187		
		Lane departure warning .....	188		
		Lane keep assist .....	190		
		Driver alert .....	192		
		<b>Fuel</b> .....	<b>193</b>		
		Fuel for petrol engines .....	193		
		Fuel for diesel engines .....	194		

## Driving hints

### Control of the vehicle

#### Never coast with engine not running

Many systems will not function in this situation (e.g. brake servo unit, power steering). Driving in this manner is a danger to yourself and others.

All systems function during an Autostop.

Stop-start system ⇨ 139.

#### Idle boost

If charging of the vehicle battery is required due to battery condition, the power output of the generator must be increased. This will be achieved by an idle boost which may be audible.

A message appears in the Driver Information Centre.

#### Pedals

To ensure the pedal travel is uninhibited, there must be no mats in the area of the pedals.

Use only floor mats, which fit properly and are fixed by the retainers on the driver side.

#### Steering

If power steering assist is lost because the engine stops or due to a system malfunction, the vehicle can be steered but may require increased effort.

## Starting and operating

### New vehicle running-in

Do not brake unnecessarily hard for the first few journeys.

During the first drive, smoke may occur because of wax and oil evaporating off the exhaust system. Park the vehicle in the open for a while after the first drive and avoid inhaling the fumes.

During the running-in period, fuel and engine oil consumption may be higher.

Additionally, the cleaning process of the diesel particle filter may take place more often.

Diesel particle filter ⇨ 142.

Autostop may be inhibited to allow charging of the vehicle battery.

### Ignition switch positions

Turn key:



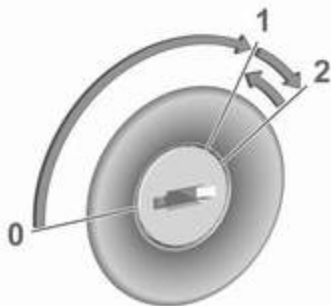

- 0 : ignition off: Some functions remain active until key is removed or driver's door is opened, provided the ignition was on previously
- 1 : ignition on power mode: Ignition is on, diesel engine is preheating. Control indicators illuminate and most electrical functions are operable
- 2 : engine start: Release key after engine has been started

### Steering wheel lock

Remove key from ignition switch and turn steering wheel until it engages.

### ⚠ Danger

Never remove the key from ignition switch during driving as this will cause steering wheel lock.

### Power button



Electronic key must be inside the vehicle.

### Engine start

Operate clutch pedal (manual transmission) or brake pedal (automatic transmission) and press **Start/Stop**. Release button after starting procedure begins. Diesel engine starts after preheating.

### Ignition on power mode without starting the engine

Press **Start/Stop** without operating clutch or brake pedal. Control indicators illuminate and most electrical functions are operable.

### Engine and ignition off

Press **Start/Stop** briefly in each mode or when engine is running and vehicle is stationary. Some functions remain active until driver's door is opened, provided the ignition was on previously.

### Emergency shut off during driving

Press **Start/Stop** for five seconds ↻ 137. Steering wheel locks as soon as vehicle is stationary.

### Steering wheel lock

The steering wheel lock activates automatically when:

- The vehicle is stationary.
- The ignition has been switched off.

To release steering wheel lock, open and close driver's door and switch on accessory mode or start the engine directly.

**⚠ Warning**

If the vehicle battery is discharged, the vehicle must not be towed, tow-started or jump-started as the steering wheel lock cannot be disengaged.

**Operation on vehicles with electronic key system in case of failure**

If either the electronic key fails or the battery of the electronic key is weak, the Driver Information Centre may display **No Remote Detected** or **Replace Battery in Remote Key** when you try to start the vehicle.



Hold the electronic key with buttons outside at the marking on the steering column cover as shown in the illustration.

Depress the clutch pedal (manual transmission) or the brake pedal (automatic transmission or manual transmission automated) and press **Start/Stop** button to start the engine.

This option is intended for emergencies only. Replace the electronic key battery as soon as possible ⇨ 23.

For unlocking or locking the doors, see fault in radio remote control unit or electronic key system ⇨ 24.

**Power saving mode**

This function manages the duration of using certain systems to avoid discharging of the vehicle battery. After the engine has stopped, some systems can still be used such as the audio and telematics system, windscreen wipers, dipped beam headlamps, courtesy lamps, etc. for a total maximum time of about forty minutes.

**Changing into power saving mode**

When a certain discharging status of the vehicle battery is achieved, the active functions are switched in standby mode. A message appears in the Driver Information Centre indicating **Power saving mode**.

A telephone call being made at this time will be maintained for around 10 minutes with the Bluetooth handsfree system of the Infotainment system.

## Deactivating power saving mode

Standby mode is reactivated automatically next time the vehicle is driven. To use the functions immediately, start the engine:

- for less than ten minutes to use the systems for approximately five minutes
- for more than ten minutes to use the systems for up to approximately thirty minutes.

Have the engine run for the duration specified to ensure that the battery charge is sufficient. Do not repeatedly and continuously restart the engine in order to charge the battery.

## Starting the engine

### Vehicles with ignition switch

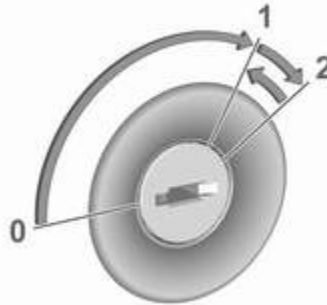

Turn key to position **1** to release the steering wheel lock.

Manual transmission: operate clutch and brake pedal.

Automatic transmission: operate brake pedal and move selector lever to **P** or **N**.

Do not operate accelerator pedal.

Diesel engines: wait until control indicator  extinguishes.

Turn key briefly to position **2** and release after engine has been started.

Manual transmission: during an Autostop, the engine can be started by depressing the clutch pedal ↻ 139.

Automatic transmission: during an Autostop, the engine can be started by releasing the brake pedal ↻ 139.

### Vehicles with power button



Manual transmission: operate clutch and brake pedal.

Automatic transmission: operate brake pedal and move selector lever to **P** or **N**.

Do not operate accelerator pedal.

Press and release **Start/Stop**: an automatic procedure operates the starter with a short delay until the engine is running.

Before restarting or to switch off the engine when vehicle is stationary, press **Start/Stop** once more briefly.

Manual transmission: during an Autostop, the engine can be started by depressing the clutch pedal ↵ 139.

Automatic transmission: during an Autostop, the engine can be started by releasing the brake pedal ↵ 139.

### Emergency shut off during driving

If the engine needs to be switched off during driving in case of emergency, press **Start/Stop** for five seconds.

### Danger

Switching off the engine during driving may cause loss of power support for brake and steering systems. Assistance systems and airbag systems are disabled. Lighting and brake lights will extinguish. Therefore power down the engine and ignition while driving only when required in case of emergency.

### Starting the vehicle at low temperatures

Starting the engine without additional heaters is possible down to -25 °C for diesel engines and -30 °C for petrol engines. Required is an engine oil with the correct viscosity, the correct fuel, performed services and a sufficiently charged vehicle battery. With temperatures below -30 °C the automatic transmission requires a warming phase of approx. five minutes. The selector lever must be in position **P**.

### Heating functionalities

#### Notice

Individual heating functionalities, such as heated seats or heated steering wheel, may be temporarily unavailable in the event of electrical loading constraints. Functions will be resumed after some minutes.

### Turbo engine warm-up

Upon start-up, engine available torque may be limited for a short time, especially when the engine temperature is cold. The limitation is to allow the lubrication system to fully protect the engine.

### Overrun cut-off

The fuel supply is automatically cut off during overrun, i.e. when the vehicle is driven with a gear engaged but accelerator pedal is released.

Depending on driving conditions, the overrun cut-off may be deactivated.

## Stop-start system

The stop-start system helps to save fuel and to reduce the exhaust emissions. When conditions allow, it switches off the engine as soon as the vehicle is at a low speed or at a standstill, e.g. at a traffic light or in a traffic jam.

### Caution

Before driving on a flooded road, deactivate the stop-start system.

### Activation

The stop-start system is available as soon as the engine is started, the vehicle starts-off and the conditions as stated below in this section are fulfilled.

## Deactivation



Deactivate the stop-start system manually by pressing . The deactivation is indicated when the LED in the button illuminates.

## Autostop

**Vehicles with manual transmission**  
An Autostop can be activated at a standstill.

Activate an Autostop as follows:

- Depress the clutch pedal.
- Set the lever to neutral.
- Release the clutch pedal.

The engine will be switched off while the ignition stays on.

**Vehicles with automatic transmission**  
If the vehicle is at a standstill with depressed brake pedal, Autostop is activated automatically.

The engine will be switched off while the ignition stays on.

The stop-start system will be disabled on inclines of 10% or more.

### Indication



An Autostop is indicated by control indicator .

During an Autostop, the heating and brake performance will be maintained.

### Conditions for an Autostop

The stop-start system checks if each of the following conditions is fulfilled.

- The stop-start system is not manually deactivated.
- The driver's door is closed or the driver's seat belt is fastened.
- The vehicle battery is sufficiently charged and in good condition.
- The engine is warmed up.
- The engine coolant temperature is not too high.
- The engine exhaust temperature is not too high, e.g. after driving with high engine load.
- The ambient temperature is above -5 °C.
- The climate control system allows an Autostop.
- The brake vacuum is sufficient.
- The self-cleaning function of the diesel particle filter is not active.
- The vehicle was driven at least at walking speed since the last Autostop.

Otherwise an Autostop will be inhibited.

Certain settings of the climate control system may inhibit an Autostop. See Climate control chapter for more details ⇨ 124.

Immediately after higher speed driving an Autostop may be inhibited.

New vehicle running-in ⇨ 134.

#### **Vehicle battery discharge protection**

To ensure reliable engine restarts, several vehicle battery discharge protection features are implemented as part of the stop-start system.

#### **Power saving measures**

During an Autostop, several electrical features such as auxiliary electric heater or rear window heating are disabled or switched to a power saving mode. The fan speed of the climate control system is reduced to save power.

#### **Restart of the engine by the driver**

##### **Vehicles with manual transmission**

Depress the clutch pedal without depressing the brake pedal to restart the engine.

##### **Vehicles with automatic transmission**

The engine is restarted if

- you release the brake pedal while the selector lever is in position **D** or **M**
- or the brake pedal is released or the selector lever is in position **N** when you move the selector lever to position **D** or **M**.
- or you move the selector lever to position **R**.

#### **Restart of the engine by the stop-start system**

The selector lever must be in neutral to enable an automatic restart.

If one of the following conditions occurs during an Autostop, the engine will be restarted automatically by the stop-start system:

- The stop-start system is manually deactivated.
- The driver's seat belt is unfastened and the driver's door is opened.
- The engine temperature is too low.

- The charging level of the vehicle battery is below a defined level.
- The brake vacuum is not sufficient.
- The vehicle is driven at least at walking speed.
- The climate control system requests an engine start.
- The air conditioning is manually switched on.

If an electrical accessory, e.g. a portable CD player, is connected to the power outlet, a brief power drop during the restart might be noticeable.

## Parking

### Warning

- Do not park the vehicle on an easily ignitable surface. The high temperature of the exhaust system could ignite the surface.
- Always apply the parking brake.
- Switch off the engine.

- If the vehicle is on a level surface or uphill slope, engage first gear or set the selector lever to position **P** before removing the ignition key or switching off ignition on vehicles with power button. On an uphill slope, turn the front wheels away from the kerb.

If the vehicle is on a downhill slope, engage reverse gear or set the selector lever to position **P** before removing the ignition key or switching off ignition on vehicles with power button. Turn the front wheels towards the kerb.

- Close the windows.
- Remove the ignition key from the ignition switch or switch off ignition on vehicles with power button. Turn the steering wheel until the steering wheel lock is felt to engage.

- Lock the vehicle.
- Activate the anti-theft alarm system.
- The engine cooling fans may run after the engine has been switched off  204.

### Caution

After running at high engine speeds or with high engine loads, operate the engine briefly at a low load or run in neutral for approx. 30 seconds before switching off, in order to protect the turbocharger.

### Notice

In the event of an accident with airbag deployment, the engine is switched off automatically if the vehicle comes to a standstill within a certain time.

## Emergency operation under extreme cold temperatures

### Warning

This emergency operation may only be carried out in case of extremely cold temperatures and if the vehicle is parked on a level surface.

In countries with extreme cold temperatures it may be necessary to park the vehicle without applied parking brake.

This is an emergency operation to avoid freezing of the parking brake.

## Engine exhaust

### Danger

Engine exhaust gases contain poisonous carbon monoxide, which is colourless and odourless and could be fatal if inhaled.



If exhaust gases enter the interior of the vehicle, open the windows. Have the cause of the fault rectified by a workshop.

Avoid driving with an open load compartment, otherwise exhaust gases could enter the vehicle.

## Diesel particle filter

### Automatic cleaning process

The diesel particle filter system filters harmful soot particles out of the exhaust gases.



The start of saturation of the particle filter is indicated by the temporary illumination of  or , accompanied by a message in the Driver Information Centre.

As soon as the traffic conditions permit, regenerate the filter by driving at a vehicle speed of at least 40 mph until the control indicator extinguishes.

### Notice

On a new vehicle, the first particle filter regeneration operations may be accompanied by a burning smell, which is normal. Following prolonged operation of the vehicle at very low speed or at idle, you may, in exceptional circumstances, notice the emission of water vapour at the exhaust on acceleration. This does not affect the behaviour of the vehicle or the environment.

### Cleaning process not possible

If  or  stays on, accompanied by an audible signal and a message, this indicates that the particle filter additive level is too low.

The reservoir must be topped-up without delay. Seek the assistance of a workshop.



## Catalytic converter

The catalytic converter reduces the amount of harmful substances in the exhaust gases.

### Caution

Fuel grades other than those listed on pages ↻ 193, ↻ 243 could damage the catalytic converter or electronic components.

Unburnt petrol will overheat and damage the catalytic converter. Therefore avoid excessive use of the starter, running the fuel tank dry and starting the engine by pushing or towing.

In the event of misfiring, uneven engine running, a reduction in engine performance or other unusual problems, have the cause of the fault rectified by a workshop as soon as possible. In an emergency, driving can be continued for a short period, keeping vehicle speed and engine speed low.

## AdBlue

### General information

The selective catalytic reduction (BlueInjection) is a method to substantially reduce the nitrogen oxides in the exhaust emission. This is achieved by injecting a Diesel Exhaust Fluid (DEF) into the exhaust system. The ammonia released by the fluid reacts with nitrous gases ( $\text{NO}_x$ ) from the exhaust and turns it into nitrogen and water.

The designation of this fluid is AdBlue®. It is a non-toxic, non-flammable, colourless and odourless fluid which consists of 32% urea and 68% water.

### Warning

Avoid contact of your eyes or skin with AdBlue.

In case of eye or skin contact, rinse off with water.

### Caution

Avoid contact of the paintwork with AdBlue.

In case of contact, rinse off with water.

AdBlue freezes at a temperature of approx.  $-11\text{ }^{\circ}\text{C}$ . As the vehicle is equipped with an AdBlue pre-heater, the emissions reduction at low temperatures is ensured. The AdBlue pre-heater works automatically.

The typical AdBlue consumption is approx. 0.85 l per 600 miles, but can also be higher depending on driving behaviour (e.g. high load or towing).

### AdBlue tank

At a remaining volume of approx. five litres, there is a liquid level switch. Warning messages are displayed only below that threshold. Tank volume ↻ 245.

## Level warnings

Depending on the calculated range of AdBlue, different messages are displayed in the Driver Information Centre. The messages and the restrictions are a legal requirement.

1. The first possible warning is **Top up emissions additive: Starting prevented in 1500 mi.**

When switching on the ignition, this warning will show up once briefly with the calculated range. Additionally, control indicator **UREA** will illuminate and a chime will sound. Driving is possible without any restrictions.

When driving, the message is displayed every 200 miles until the additive tank has been topped-up.

2. The next warning level is entered with a range below 350 miles. The message with the current range will always be displayed when ignition is switched on. Additionally, control indicator **UREA** will flash and a chime will

sound. Refill AdBlue before entering the next warning level.

When driving, the message is displayed every 30 seconds until the additive tank has been topped-up.

3. The last warning level is entered when the AdBlue tank is empty. Restart of the engine is not possible. The following warning message will be displayed:

### **Top up emissions additive: Starting prevented**

Additionally, control indicator **UREA** will flash and a chime will sound.

The tank must be refilled with at least 3.8 litres of AdBlue, otherwise restarting of the engine is not possible.

## High emission warnings

In the event of a fault with the emissions control system, different messages are displayed in the Driver Information Centre. The messages and the restrictions are a legal requirement.

1. If a fault is detected for the first time, the warning **Emissions fault** is displayed.

Additionally, control indicators **UREA, SERVICE** and  will illuminate and a chime will sound. Driving is possible without any restrictions.

If it is a temporary fault, the alert disappears during the next journey, after self-diagnosis of the emissions control system.

2. If the fault is confirmed by the emission control system, the following message will be displayed:

### **Emissions fault: Starting prevented in 650 miles.**

Additionally, control indicators **UREA, SERVICE** and  will illuminate and a chime will sound.

When driving, the message is displayed every 30 seconds while the fault persists.

3. If the last warning level is entered, the following warning message will be displayed:

**Emissions fault: Starting prevented**

Additionally, control indicators **UREA, SERVICE** and  will illuminate and a chime will sound.

Consult a workshop for assistance.

**Refilling AdBlue****Caution**

Only use AdBlue that complies with European standards DIN 70 070 and ISO 22241-1.

Do not use additives.

Do not dilute AdBlue.

Otherwise the selective catalytic reduction system could be damaged.

**Notice**

Whenever a filling pump with a nozzle for passenger cars is not available at a filling station, use only AdBlue bottles or canisters with a sealed refill adapter for refilling, to prevent splashback and overspill, and in order to ensure that the fumes

from the tank are captured and do not emerge. AdBlue in bottles or canisters is available in many filling stations and can be purchased e.g. at Vauxhall dealers and other retail outlets.

Since AdBlue has a limited durability, check the date of expiry before refilling.

**Notice**

The refilling of AdBlue is only detected by the system when the abovementioned liquid level switch in the tank is activated.

In case AdBlue refill is not successfully detected:

1. Continuously drive the vehicle for 10 minutes making sure that vehicle speed is always higher than 12 mph.
2. If AdBlue refill is detected successfully, AdBlue supply-driven limitations will disappear.

If AdBlue refill is still not detected, seek the assistance of a workshop.

If AdBlue must be refilled at temperatures below -11 °C, the refilling of AdBlue may not be

detected by the system. In this event, park the vehicle in a space with a higher ambient temperature until AdBlue is liquefied.

**Notice**

When unscrewing the protective cap from the filler neck, ammonia fumes may emerge. Do not inhale as the fumes have a pungent smell. The fumes are not harmful by inhalation.

The AdBlue tank should be filled completely. This must be done if the warning message regarding prevention of an engine restart is already displayed.

The vehicle must be parked on a level surface.

The filler neck for AdBlue is located behind the fuel filler flap, which is located at right rear side of the vehicle.

The fuel filler flap can only be opened if the vehicle is unlocked.

1. Remove key from ignition switch.
2. Close all doors to avoid ammonia fumes entering the interior of the vehicle.

- Release the fuel filler flap by pushing the flap ↗ 195.



- Unscrew protective cap from the filler neck.
- Open AdBlue canister.
- Mount one end of the hose on the canister and screw the other end on the filler neck.
- Lift the canister until it is empty, or until the flow from the canister has stopped. This can take up to five minutes.
- Place the canister on the ground to empty the hose, wait 15 seconds.

- Unscrew the hose from the filler neck.
- Mount the protective cap and turn clockwise until it engages.

**Notice**

Dispose of AdBlue canister according to environmental requirements. Hose can be reused after flushing with clear water before AdBlue dries out.

## Automatic transmission

The automatic transmission permits automatic gearshifting (automatic mode) or manual gearshifting (manual mode).

Manual shifting is possible in manual mode by tapping the selector lever to + or - ↗ 148.

## Transmission display



The mode or selected gear is shown in the Driver Information Centre.

In automatic mode, the driving programme is indicated by D.

In manual mode, **M** and the number of the selected gear is indicated.

**R** indicates reverse gear.

**N** indicates neutral position.

**P** indicates park position.

## Selector lever



Move the selector lever in the shifting gate as shown in the illustration above.

**P** : park position, wheels are locked, engage only when the vehicle is stationary and the parking brake is applied

**R** : reverse gear, engage only when the vehicle is stationary

**N** : neutral

**D** : automatic mode

**M** : manual mode

**+** : upshift in manual mode

**-** : downshift in manual mode

The selector lever is locked in **P** and can only be moved when the ignition is on and the brake pedal is applied.

The engine can only be started with the lever in position **P** or **N**. When position **N** is selected, press the brake pedal or apply the parking brake before starting.

Do not accelerate while engaging a gear. Never depress the accelerator pedal and brake pedal at the same time.

When a gear is engaged, the vehicle slowly begins to creep when the brake is released.

## Engine braking

To utilise the engine braking effect, select a lower gear in good time when driving downhill, see manual mode.

## Rocking the vehicle

Rocking the vehicle is only permissible if the vehicle is stuck in sand, mud or snow. Move the selector lever between **D** and **R** in a repeat pattern. Do not race the engine and avoid sudden acceleration.

## Parking

Apply the parking brake and engage **P**.

## Manual mode



Move selector lever out of position **D** towards the left in position **M**.

Tap selector lever upwards **+** to shift to a higher gear.

Tap the selector lever downwards **-** to shift to a lower gear.

If a higher gear is selected when vehicle speed is too low, or a lower gear when vehicle speed is too high, the shift is not executed. This can cause a message in the Driver Information Centre.

In manual mode, no automatic shifting to a higher gear takes place at high engine revolutions.

### Gear shift indication

The symbol ▲ or ▼ with a number beside it is indicated when gearshifting is recommended for fuel saving reasons.

Shift indication appears only in manual mode.

## Electronic driving programmes

- Following a cold start, the operating temperature programme increases engine speed to quickly bring the catalytic converter to the required temperature.
- Special programmes automatically adapt the shifting points when driving up inclines or down hills.
- In snowy or icy conditions or on other slippery surfaces, the electronic transmission control

enables the driver to select manually first, second or third gear for starting off.

### Kickdown

Pressing down the accelerator pedal beyond the kickdown detent will lead to maximum acceleration independent of selected driving mode. The transmission shifts to a lower gear depending on engine speed.

## Fault

In the event of a fault a message is displayed in the Driver Information Centre. Vehicle messages ⇨ 103.

Electronic transmission control enables only third gear. The transmission no longer shifts automatically.

Do not drive faster than 62 mph.

Have the cause of the fault remedied by a workshop.

## Interruption of power supply

In the event of an interruption of power supply, the selector lever cannot be moved out of the **P** position. The ignition key cannot be removed from the ignition switch.

If the vehicle battery is discharged, start the vehicle using jump leads ⇨ 228.

If the vehicle battery is not the cause of the fault, release the selector lever.

1. Apply the parking brake.
2. Release the selector lever trim from the centre console. Poke with a finger into the leather socket below the selector lever and push the trim upwards.



3. Push down the button and move the selector lever out of **P**. Have the cause of the power supply interruption remedied by a workshop.
4. Mount the selector lever trim onto the centre console and refit.

## Manual transmission



To engage reverse on 6-speed transmission, depress the clutch pedal, pull the ring under the selector lever and move the selector lever quite to the left and front.

If the gear does not engage, set the lever to neutral, release the clutch pedal and depress again; then repeat gear selection.

Do not slip the clutch unnecessarily.

When operating, depress the clutch pedal completely. Do not use the pedal as a foot rest.

When clutch slip is detected for a specific time, the engine power will be reduced. A warning is displayed in the Driver Information Centre. Release the clutch.

**Caution**

It is not advisable to drive with the hand resting on the selector lever.

Gear shift indication ↗ 96.

Stop-start system ↗ 139.

## Brakes

The brake system comprises two independent brake circuits.

If a brake circuit fails, the vehicle can still be braked using the other brake circuit. However, braking effect is achieved only when the brake pedal is depressed firmly. Considerably more force is needed for this. The braking distance is extended. Seek the assistance of a workshop before continuing the journey.

When the engine is not running, the support of the brake servo unit disappears once the brake pedal has been depressed once or twice. Braking effect is not reduced, but braking requires significantly greater force. It is especially important to bear this in mind when being towed.

Control indicator (P) ↗ 95.

### Antilock brake system

Antilock brake system (ABS) prevents the wheels from locking.

ABS starts to regulate brake pressure as soon as a wheel shows a tendency to lock. The vehicle remains steerable, even during hard braking.

ABS control is made apparent through a pulse in the brake pedal and the noise of the regulation process.

For optimum braking, keep the brake pedal fully depressed throughout the braking process, despite the fact that the pedal is pulsating. Do not reduce the pressure on the pedal.

After starting off, the system performs a self-test which may be audible.



Control indicator (ABS) ↗ 95.

### Adaptive brake light

During full braking, all three brake lights flash for the duration of ABS control.



**Fault****⚠ Warning**

If there is a fault in the ABS, the wheels may be liable to lock due to braking that is heavier than normal. The advantages of ABS are no longer available. During hard braking, the vehicle can no longer be steered and may swerve.

Have the cause of the fault remedied by a workshop.

**Parking brake****⚠ Warning**

Before leaving the vehicle, check parking brake status. Control indicator (P) must illuminate constantly.

**Electric parking brake****Applying when vehicle is stationary****⚠ Warning**

Pull switch (P) for a minimum of one second until control indicator (P) illuminates constantly and electric parking brake is applied ⇨ 95. The electric parking brake operates automatically with adequate force.

Before leaving the vehicle, check the electric parking brake status. Control indicator (P) ⇨ 95.

The electric parking brake can always be activated, even if the ignition is off.

Do not operate electric parking brake system too often without engine running as this will discharge the vehicle battery.

**Releasing**

Switch on ignition. Keep foot brake pedal depressed and then push switch (P).

**Drive away function**

Vehicles with manual transmission: Depressing the clutch pedal and then slightly releasing the clutch pedal and slightly depressing the accelerator pedal releases the electric parking brake automatically. This is not possible when switch (P) is pulled at the same time.

Vehicles with automatic transmission: Engaging **D** and then depressing the accelerator pedal releases the electric parking brake automatically. This is not possible when switch (P) is pulled at the same time.

### Dynamic braking when vehicle is moving

When the vehicle is moving and the switch (P) is kept pulled, the electric parking brake system will decelerate the vehicle, but will not apply statically.

As soon as the switch (P) is released, dynamic braking will be stopped.

### Automatic operation

Automatic operation includes automatic application and automatic release of the electric parking brake.

The electric parking brake can also be applied or released manually by using the switch (P).

Automatic application:

- The electric parking brake is automatically applied when the vehicle is stationary and the ignition is switched off.
- (P) illuminates in the instrument cluster and a display message pops up to confirm the application.

Automatic release:

- Parking brake releases automatically after moving off.
- (P) extinguishes in the instrument cluster and a display message pops up to confirm the release.

If the vehicle is equipped with an automatic transmission and the brake is not released automatically, make sure the front doors are correctly closed.

### Deactivation of automatic operation

1. Start the engine.
2. If the parking brake is released, apply the parking brake pulling the switch (P).
3. Take your foot off the brake pedal.
4. Press the switch (P) for at least 10 seconds and maximum 15 seconds.
5. Release the switch (P).
6. Press and hold the brake pedal.
7. Pull the switch (P) for 2 seconds.

The deactivation of the automatic operation of the electric parking brake is confirmed by (P) illuminating in the

instrument cluster ↷ 95. The electric parking brake can only be applied and released manually.

To reactivate the automatic operation, repeat the steps described above.

### Functionality check

When the vehicle is not moving, the electric parking brake might be applied automatically. This is done to check the system.

### Fault

Failure mode of electric parking brake is indicated by a control indicator (P) and by a vehicle message which is displayed in the Driver Information Centre. Vehicle messages ↷ 103.

Apply electric parking brake: pull and hold the switch (P) for more than five seconds. If control indicator (P) illuminates, electric parking brake is applied.

Release electric parking brake: push and hold the switch (P) for more than two seconds. If control indicator (P) extinguishes, electric parking brake is released.

Control indicator  flashes: electric parking brake is not fully applied or released. When continuously flashing, release electric parking brake and retry applying.

## Brake assist

If brake pedal is depressed quickly and forcefully, maximum brake force is automatically applied.

Operation of brake assist might become apparent by a pulse in the brake pedal and a greater resistance when depressing the brake pedal.

Maintain steady pressure on the brake pedal as long as full braking is required. Maximum brake force is automatically reduced when brake pedal is released.

## Hill start assist

The system helps prevent unintended movement when driving away on inclines.

When releasing the brake pedal after stopping on an incline, brakes remain on for further two seconds. The brakes release automatically as soon as the vehicle begins to accelerate.

## Ride control systems

### Electronic Stability Control and Traction Control system

Electronic Stability Control improves driving stability when necessary, regardless of the type of road surface or tyre grip.

As soon as the vehicle starts to swerve (understeer/oversteer), engine output is reduced and the wheels are braked individually.

Electronic Stability Control operates in combination with the Traction Control system. It prevents the driven wheels from spinning.

The Traction Control system is a component of the Electronic Stability Control.

Traction Control improves driving stability when necessary, regardless of the type of road surface or tyre grip, by preventing the driven wheels from spinning.

As soon as the driven wheels starts to spin, engine output is reduced and the wheel spinning the most is braked

individually. This considerably improves the driving stability of the vehicle on slippery road surfaces.



Electronic Stability Control and Traction Control are operational after each engine start as soon as the control indicator  extinguishes.

When Electronic Stability Control and Traction Control operate,  flashes.

### Warning

Do not let this special safety feature tempt you into taking risks when driving.

Adapt speed to the road conditions.

Control indicator  ⇨ 96.

## Deactivation



Electronic Stability Control and Traction Control can be deactivated, everytime it is required: press .

The LED in the button  illuminates.

A status message appears in the Driver Information Centre when Electronic Stability Control Traction Control are deactivated.

Electronic Stability Control and Traction Control are reactivated by pressing the  button again, by applying the brake or in the case that the vehicle is driven faster than 30 mph.

The LED in the button  extinguishes when Electronic Stability Control and Traction Control are reactivated.

Electronic Stability Control and Traction Control are also reactivated the next time the ignition is switched on.

## Fault

If there is a fault in the system, the control indicator  illuminates continuously and a message appears in the Driver Information Centre. The system is not operational.

Have the cause of the fault remedied by a workshop.

## Selective ride control

### Caution

The vehicle is designed to drive principally on tarmac roads, but it also enables driving off-road occasionally.

However, do not drive on terrain where your vehicle could be damaged due to obstacles, such as stones among others and on terrain with steep inclines and poor grip.

Do not cross streams.

### Caution

When driving off-road, sudden motion and manoeuvres can make you lose of the steering. This could cause a collision. Therefore, when driving on-road and off-road, you and your passengers should wear seat belts.

Selective ride control is designed to optimise traction in low-grip conditions (snow, mud and sand). It adapts to the terrain by acting on the front wheels, in doing so this saves the weight normally associated with a more conventional four wheel drive system.



Selective ride control allows to choose between five driving modes:

- ESC off mode
- Standard mode
- Snow mode
- Mud mode
- Sand mode

The several modes can be activated by turning the control.

A LED illuminates and a status message appears in the Driver Information Centre to confirm the chosen mode.

### ESC off mode



The Electronic Stability Control and Traction Control are deactivated in this mode.

A LED in the button  illuminates.

Electronic Stability Control and Traction Control are reactivated automatically from 30 mph or everytime the ignition is switched on.

### Standard mode



This mode is calibrated for a low level of wheel spin, based on the different types of grip generally encountered in normal day to day driving.

Everytime the ignition is switched off, the system is automatically reset to this mode.

### Snow mode



This mode adapts to the grip conditions encountered by each wheel when starting.

When advancing, the system optimises wheel spin to guarantee the best acceleration based on the available traction. Recommended in cases of deep snow and steep inclines.

This mode is active up to a speed of 30 mph.

### Mud mode



This mode allows considerable wheel spin at start-up for the wheel with the least grip, this removes mud and re-establishes traction.

Simultaneously, the wheel with the most grip is provided with the most torque possible.

This mode is active up to a speed of 50 mph.

## Sand mode



This mode allows a small amount of simultaneous wheel spin on the two drive wheels, enabling the vehicle to advance and reduce the risk of sinking.

This mode is active up to a speed of 75 mph.

### Caution

Do not use the other modes on sand as the vehicle may become stuck.

## Sport mode



Sport mode adapts the settings of some vehicle systems to a sportier driving style.

### Activation

Press **SPORT** when engine is running.

LED in the button illuminates when Sport mode is active and a status message appears in the Driver Information Centre.

## Deactivation

Briefly press **SPORT**. Sport mode is deactivated the next time the ignition is switched on.

## Driver assistance systems

### ⚠ Warning

Driver assistance systems are developed to support the driver and not to replace the driver's attention.

The driver accepts full responsibility when driving the vehicle.

When using driver assistance systems, always take care regarding the current traffic situation.

## Cruise control

The cruise control can store and maintain speeds above 25 mph. Additionally at least the third gear must be engaged on manual transmission, on automatic transmission position **D** or the second or a higher gear in position **M** must be selected.

Deviations from the stored speeds may occur when driving uphill or downhill.

The system maintains the vehicle speed at the preset speed by the driver, without any action on the accelerator pedal.

The preset speed can be exceeded temporarily by pressing the accelerator pedal.

The status and preset speed is displayed in the Driver Information Centre.



Do not use the cruise control if it is not advisable to maintain a constant speed.

Activating in first gear is not possible.

Control indicator   99.

## Switching on



Press  on the steering wheel: symbol  and **Pause** are indicated in the Driver Information Centre. The system is still not active.





## Activation

### Setting speed by the driver



Accelerate to the desired speed and press toggle switch once briefly to **RES/+** or **SET/-**. The current speed is stored and maintained. Accelerator pedal can be released.

The preset speed can then be changed by pressing toggle switch to **RES/+** to increase or **SET/-** to decrease the speed. Short press changes speed in small steps, long press in large steps.



Speed value is indicated in the Driver Information Centre.

### Adopting speed by the traffic sign assistant

The intelligent speed adaptation informs the driver when a speed limit is detected by the traffic sign assistant. The detected speed limit can be used as new value for the cruise control.

Using a camera at the top of the windscreen, this system detects and reads speed limit and end of speed limit signs. The system also takes account of information on speed limits from of the map data of the navigation system.

The function can be deactivated or activated in the personalisation menu, ↗ 104.

If the cruise control is active, the recognised speed limit will be displayed in the Driver Information Centre and **MEM** illuminates.

The information displayed in the Driver Information Centre depends on the display used.

In the Driver Information Centre, speed limit sign is shown in the display and **MEM** illuminates for a few seconds.

Press **MEM** on the steering wheel to request saving of the suggested speed.

Press **MEM** on the steering wheel once more to confirm and save the new speed setting.

This speed is the new value for the cruise control.

### Exceeding the set speed

Vehicle speed can be increased by depressing the accelerator pedal. When the accelerator pedal is released, the previously stored speed is resumed.

### Deactivation

Press : cruise control is in pause mode, Pause is indicated. The vehicle is driven without cruise control.

Cruise control is deactivated, but not switched off. Last stored speed remains in memory for later speed resume.

Cruise control is deactivated automatically:

- The brake pedal is depressed.
- The clutch pedal is depressed.
- Vehicle speed is below 25 mph.
- The Traction Control system or Electronic Stability Control is operating.
- The selector lever is in **N**.

### Resume stored speed

Press toggle switch to **RES/+** at a speed above 25 mph. The stored speed will be obtained.

### Switching off

Press : the cruise control mode is deselected and the cruise control indication extinguishes in the Driver Information Centre.

Pressing  to activate the speed limiter deactivates cruise control.

Switching off the ignition cancels any programmed speed value.

### Fault

In the event of a cruise control fault, the speed is cleared resulting in flashing of the dashes.

The cruise control may not operate correctly if traffic signs do not comply with the Vienna Convention on Road Signs and Signals (Wiener Übereinkommen über Straßenverkehrszeichen).

### Speed limiter

The speed limiter prevents the vehicle exceeding a preset maximum speed.

The maximum speed can be set at speeds above 18 mph.



The driver can accelerate the vehicle up to the preset speed. Deviations from the limited speed may occur when driving downhill.

The preset speed can be exceeded temporarily by pressing the accelerator pedal firmly.

The status and preset speed limit is displayed in the Driver Information Centre.

## Switching on



Press , symbol  and Pause are indicated in the Driver Information Centre. The system is still not active.

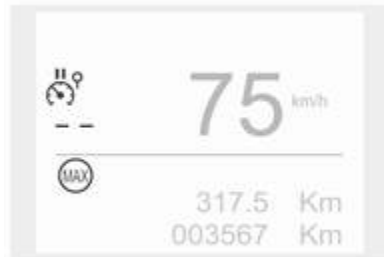

## Activation

### Setting speed by the driver



Press toggle switch once briefly to **RES/+** or **SET/-**.

Following the preset speed can be set by pressing toggle switch to **RES/+** to increase or **SET/-** to decrease the desired maximum speed. Short press changes preset speed in small steps, long press in large steps. Speed value is indicated in the Driver Information Centre.



Press  to activate speed limiter.

### Adopting speed by the traffic sign assistant

The intelligent speed adaptation informs the driver when a speed limit is detected by the traffic sign assistant. The detected speed limit can be used as new value for the speed limiter.

Using a camera at the top of the windscreen, this system detects and reads speed limit and end of speed limit signs. The system also takes account of information on speed limits from of the map data of the navigation system.

The function can be deactivated or activated in the personalisation menu, ↗ 104.

If the speed limiter is active, the recognised speed limit will be displayed in the Driver Information Centre and **MEM** illuminates.

The information displayed in the Driver Information Centre depends on the display used.

In the Driver Information Centre, speed limit sign is shown in the display and **MEM** illuminates for a few seconds.

Press **MEM** on the steering wheel to request saving of the suggested speed.

Press **MEM** on the steering wheel once more to confirm and save the new speed setting.

This speed is the new value for the speed limiter.

### Exceeding the speed limit

In the event of an emergency, it is possible to exceed the speed limit by a "kickdown". In this case the preset speed value flashes.

Release the accelerator pedal and the speed limiter function is reactivated once a speed lower than the limit speed is obtained.

### Deactivation

Press : speed limiter is in pause mode, Pause is indicated. The vehicle is driven without speed limit.

Speed limiter is deactivated, but not switched off. Last stored speed remains in memory for later speed resume.

### Resume limit speed

Press . The stored speed limit will be obtained.

### Switching off

Press , the speed limiter mode is deselected and the speed limit indication extinguishes in the Driver Information Centre.

Pressing  to activate cruise control deactivates speed limiter.

The preset speed remains in the memory when the ignition is switched off.

### Fault

In the event of a speed limiter fault, the speed is cleared resulting in flashing of the dashes.

The speed limiter may not operate correctly if traffic signs do not comply with the Vienna Convention on Road Signs and Signals (Wiener Übereinkommen über Straßenverkehrszeichen).

### Adaptive cruise control

Adaptive cruise control is an enhancement to conventional cruise control with the additional feature of maintaining a certain distance behind the vehicle ahead. It uses radar and camera sensors to detect the vehicles ahead. If no vehicle is detected in the driving path, the adaptive cruise control will behave like a conventional cruise control.

Adaptive cruise control automatically decelerates the vehicle when approaching a slower moving vehicle. It then adjusts the vehicle speed to follow the vehicle ahead at the selected following distance. The

vehicle speed increases or decreases to follow the vehicle in front, but will not exceed the set speed. It may apply limited braking with activated brake lights.



If the vehicle in front accelerates or changes lane, the adaptive cruise control progressively accelerates your vehicle to return to the programmed speed. If the driver operates a direction indicator to overtake a slower vehicle, the adaptive cruise control allows your vehicle to temporarily approach the vehicle in front to assist the overtaking manoeuvre, though never exceeding the programmed speed.

### **⚠ Warning**

The complete driver attention is always required while driving with adaptive cruise control. The driver stays fully in control of the vehicle because the brake pedal, the accelerator pedal and the cancel switch have priority over any adaptive cruise control operation.

### Switching on



Press  to switch on the steering wheel: symbol  is indicated in the Driver Information Centre. The system is still not active.



### Activation

Adaptive cruise control is switched on manually at a speed between 25 and 112 mph. For vehicles with automatic transmission, the automatic selector lever must be in position **D** or **M**.

### Setting the speed by the driver

Accelerate to the desired speed and press toggle switch once briefly to **RES/+** or **SET/-**. The current speed is stored and maintained. Accelerator pedal can be released.

The preset speed can then be changed by pressing toggle switch to **RES/+** to increase or **SET/-** to

decrease the speed. Short press changes speed in small steps, long press in large steps.



The speed value is indicated in the Driver Information Centre.

When the cruise control is operating, Stop & Start is automatically deactivated.

### Adopting speed by the traffic sign assistant

The intelligent speed adaptation informs the driver when a speed limit is detected by the traffic sign assistant. The detected speed limit can be used as new value for the cruise control.

Using a camera at the top of the windscreen, this system detects and reads speed limit and end of speed limit signs. The system also takes account of information on speed limits from of the map data of the navigation system.

The function can be deactivated or activated in the personalisation menu, ↗ 104.

If the cruise control is active, the recognised speed limit will be displayed in the Driver Information Centre and **MEM** illuminates.

The information displayed in the Driver Information Centre depends on the display used.

In the Driver Information Centre, speed limit sign is shown in the display and **MEM** illuminates for a few seconds.

Press **MEM** on the steering wheel to request saving of the suggested speed.

Press **MEM** on the steering wheel once more to confirm and save the new speed setting.

This speed is the new value for the cruise control.

### Exceeding the set speed

It is always possible to drive faster than the selected set speed by depressing the accelerator pedal. When the accelerator pedal is released, the vehicle returns to the desired distance if a slower vehicle is ahead. Otherwise it returns to the stored speed.

Once the system is activated, adaptive cruise control decelerates or brakes if it detects a vehicle ahead, which is slower or closer than the desired following distance.

If the programmed speed setting is exceeded, the display of the speed setting disappears and a message "Cruise control suspended" is displayed until the accelerator pedal is released.

**⚠ Warning**

Accelerating by the driver deactivates automatic braking by the system. This is indicated as a pop-up warning in the Driver Information Centre.



**Full speed range adaptive cruise control on vehicles with automatic transmission**

Full speed range adaptive cruise control will maintain a following distance behind a detected vehicle and slow your vehicle to a stop behind that vehicle.

In case of a brief stop of the vehicle ahead the adaptive cruise control will drive off automatically without driver action. If necessary, press **RES/+** or the accelerator pedal to resume adaptive cruise control.

If the stopped vehicle ahead was stopped for a longer time and then begins to move forward, the green illuminated vehicle ahead control

indicator A will flash and a warning chime will sound as a reminder to check traffic before resuming.

When the vehicle ahead drives away, press **RES+** or the accelerator pedal to resume adaptive cruise control. If stopped for more than five minutes or if the driver's door is opened and the driver's seat belt is unbuckled, the electric parking brake is applied automatically to hold the vehicle. Control indicator  will illuminate. To release electric parking brake, press the accelerator pedal. Electric parking brake  151.

**⚠ Warning**

When full speed range adaptive cruise control is deactivated or cancelled, the vehicle will no longer be held at a stop and can start to move. Always be prepared to manually apply the brake to hold the vehicle stationary.

Do not leave the vehicle while it is being held at a stop by the full speed range adaptive cruise control. Always move selector

lever to park position **P** and switch off the ignition before leaving the vehicle.

**Setting the following distance**

When adaptive cruise control detects a slower moving vehicle in the driving path, it will adjust the vehicle speed to maintain the following distance selected by the driver.

The following distance can be set to close (1 dash), normal (2 dashes) or distant (3 dashes).

If the engine is running and the adaptive cruise control is selected (grey), you can modify the following distance setting:

Press , the current setting is shown in the Driver Information Centre.

Press  again to change the following distance. The setting is also displayed in the Driver Information Centre.

The selected following distance is indicated by filled distance bars in the adaptive cruise control page.

**Warning**

The driver accepts full responsibility for the appropriate following distance based on traffic, weather and visibility conditions. Following distance must be adjusted or the system switched off when required by the prevailing conditions.

**Deactivation**

Press **RES+**: cruise control is in pause mode, Pause is indicated. The vehicle is driven without cruise control.

Cruise control is deactivated, but not switched off. Last stored speed remains in memory for later speed resume.

Cruise control is deactivated automatically:

- The brake pedal is depressed.
- The clutch pedal is depressed.
- Vehicle speed is below 25 mph.
- The Traction Control system or Electronic Stability Control is operating.
- For vehicles with automatic transmission, the selector lever is in N.

**Resume stored speed**

Press toggle switch to **RES/+** at a speed above 25 mph. The stored speed will be obtained.

**Switching off**

Press **OFF**: the adaptive cruise control mode is deselected and the cruise control indication extinguishes in the Driver Information Centre.

Pressing **OFF** to activate the speed limiter deactivates cruise control.

Switching off the ignition cancels any programmed speed value.

**Driver's attention**

- Use adaptive cruise control carefully on bends or mountain roads, as it can lose the vehicle ahead and needs time to detect it again.
- Do not use the system on slippery roads as it can create rapid changes in tyre traction (wheel spinning), so that you could lose control of the vehicle.
- Do not use adaptive cruise control during rain, snow or heavy dirt, as the radar sensor can be covered by a water film, dust, ice or snow. This reduces or suppresses completely the visibility. In case of sensor blockage, clean the sensor cover.
- Do not use the system when the spare wheel is in use.



## System limits

### ⚠ Warning

The system's automatic brake force does not permit hard braking and the braking level may not be sufficient to avoid a collision.

- After a sudden lane change, the system needs a certain time to detect the next preceding vehicle. So if a new vehicle is detected, the system may accelerate instead of braking.
- Adaptive cruise control does ignore the oncoming traffic.
- Adaptive cruise control does not consider pedestrians and animals for braking and driving off.
- Adaptive cruise control considers stopped vehicles only at low speed.

- Do not use adaptive cruise control when towing a trailer.
- Do not use adaptive cruise control on roads with an incline of more than 10%.

As the radar's field of detection is quite narrow, it is possible that the system may not detect:

- Vehicles of reduced width (motorcycles, scooters...).
- Vehicles not running in the middle of the lane,
- Vehicles entering a corner.
- Vehicles suddenly pulling out.

### Bends

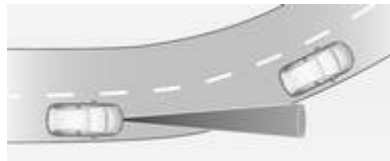

The adaptive cruise control calculates a predicted path based on the centrifugal force. This predicted path considers the current bend characteristic, but cannot consider a

future bend change. The system may lose the current vehicle ahead or consider a vehicle which is not in the actual lane. This can happen when entering or exiting a bend or if the bend gets stronger or weaker. If it no longer detects any vehicle ahead, then control indicator  will extinguish.

If the centrifugal force is too high in a bend, the system slows down the vehicle slightly. This braking level is not designed to avoid spinning-off the bend. The driver is responsible for reducing the selected speed before entering a bend and in general to adapt the speed to the road type and to existing speed limits.

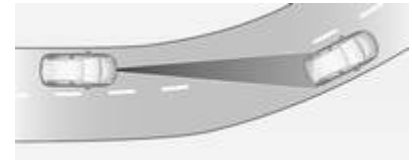

### Motorways

On motorways, adapt the set speed to the situation and the weather. Always consider that adaptive cruise control has a limited visibility range, a limited braking level and a certain reaction time to verify if a vehicle is on the driving path or not. Adaptive cruise control may not be able to brake the vehicle in time to avoid a collision with a much slower vehicle or after a lane change. This is particularly true while driving fast or if the visibility is reduced due to weather conditions.

While entering or exiting a motorway, adaptive cruise control may lose the vehicle ahead and accelerate up to the set speed. For this reason, decrease the set speed before the exit or before the entry.

### Vehicle path changes



If another vehicle enters your driving path, adaptive cruise control will first consider the vehicle when it is completely in your path. Be ready to take action and depress the brake pedal, if you need to brake more quickly.

### Hill and trailer considerations



#### ⚠ Warning

Do not use adaptive cruise control on steep hill roads.

System performance on hills depends on vehicle speed, vehicle load, traffic conditions and the road gradient. It may not detect a vehicle in your path while driving on hills. On steep hills, you may have to use the accelerator pedal to maintain your vehicle speed.

When going downhill you may have to brake to maintain or reduce your speed.

Note that applying the brake deactivates the system.

### Radar unit



The radar unit is located in the middle of the front bumper.

#### ⚠ Warning

The radar unit was aligned carefully during manufacture. Therefore, after a frontal accident, do not use the system. The front

bumper may appear to be intact, however the sensor behind can be out of position and react incorrectly. After an accident, consult a workshop to verify and correct the adaptive cruise control sensor position.

## Fault

In the event of a fault with the cruise control, you are alerted by the illumination of a warning lamp and the display of a message in the instrument panel, accompanied by an audible signal.

The adaptive cruise control may not operate correctly if traffic signs do not comply with the Vienna Convention on Road Signs and Signals (Wiener Übereinkommen über Straßenverkehrszeichen).

Have the system checked by a dealer or a qualified workshop.

As a safety measure, do not use the system if the brake lamps are faulty. Do not use the system if the front bumper is damaged.

## Forward collision alert

The forward collision alert may help to avoid or reduce the harm caused by front-end crashes.

The forward collision alert uses the front camera in the windscreen and a radar unit located behind the front bumper of the vehicle to detect a vehicle directly ahead, in your path.

If a vehicle directly ahead is approached too quickly, a warning chime and alert in the Driver Information Centre is provided.

## Activation

Forward collision alert detects vehicles and operates automatically at all speeds above 3 mph and 87 km/h.

## Alerting the driver

The system triggers different level of alerts depending on the risk of collision detected. The alerts are displayed in the instrument cluster.

Level 1: A visual alert is displayed.

Level 2: A visual alert is displayed and an audible alert is triggered.

## Caution

The colour lighting of this control indicator does not correspond to local traffic laws on following distance. The driver bears full responsibility for maintaining safe following distance according to applicable traffic rules, weather and road conditions etc. at all times.

When the time to a potential collision with a vehicle in front gets too small and a collision is imminent, a warning is displayed in the Driver Information Centre.

Simultaneously a warning chime sounds. Depress the brake pedal and steer the vehicle, if it is required by the situation.

## Selecting the alert sensitivity

7" Colour-Info-Display: Adjust the alert sensitivity in the vehicle personalisation, ↗ 104.

8" Colour-Info-Display: Adjust the alert sensitivity in the settings of the active emergency braking in the vehicle personalisation, ⇨ 104.

The chosen setting will remain until it is changed. The alert timing will vary based on vehicle speed. The faster the vehicle speed, the farther away the alert will occur. Consider traffic and weather conditions when selecting the alert timing.

### Deactivation

The system can only be deactivated by deactivating the active emergency braking in the vehicle personalisation, ⇨ 104.

### General information

#### Warning

Forward collision alert is just a warning system and does not apply the brakes. When approaching a vehicle ahead too rapidly, it may not provide you enough time to avoid a collision.

The driver accepts full responsibility for the appropriate following distance based on traffic, weather and visibility conditions.

The complete attention of the driver is always required while driving. The driver must always be ready to take action and apply the brakes.

### System limitations

Forward collision alert is designed to warn on vehicles only, but may react also to other objects.

In the following cases, Forward collision alert may not detect a vehicle ahead or sensor performance is limited:

- Driving on winding or hilly roads.
- During nighttime driving.
- Weather limits visibility, such as fog, rain, or snow

- The sensor in the windscreen or the radar unit behind the front bumper are blocked by snow, ice, slush, mud, dirt etc.
- The windscreen is damaged or affected by foreign items, e.g. stickers.

### Active emergency braking

Active emergency braking can help to reduce the damage and injury from crashes with vehicles, pedestrians and obstacles directly ahead, when a collision can no longer be avoided either by manual braking or by steering. Before the active emergency braking applies, the driver is warned by the Forward collision alert ⇨ 169 or the Front pedestrian protection alert ⇨ 173.

The feature uses various inputs (e.g. camera sensor, radar sensor, brake pressure, vehicle speed) to calculate the probability of a frontal collision.

### Warning

This system is not intended to replace the driver responsibility for driving the vehicle and looking ahead. Its function is limited to supplemental use only to reduce the vehicle speed before a collision.

The system may not react to animals. After a sudden lane change, the system needs a certain time to detect the next preceding vehicle.

The driver must always be ready to take action and apply the brakes and steer to avoid collisions.

### Functionality

If equipped only with front camera the active emergency braking operates in forward gear above walking speed up to 53 mph. With radar sensor and front camera active emergency braking operates in forward gear above walking speeds to 87 mph.

A precondition is that forward collision alert with front camera system is not deactivated in the vehicle personalisation menu ⇨ 104.

The system includes:

- brake preparation system
- emergency automatic braking
- forward looking brake assist
- intelligent brake assist (only with radar sensor)
- forward collision alert
- front pedestrian protection

### Brake preparation system

When approaching a vehicle ahead or a pedestrian so quickly that a collision is likely, the brake preparation system slightly pressurizes the brakes. This reduces the response time, when a manual or automatic braking is requested.

The brake system is prepared so that braking can occur more rapidly.

### Emergency automatic braking

After activation of brake preparation system and just before the imminent collision, this function automatically applies limited braking to reduce the impact speed of the collision or prohibit a crash. Depending on the situation, the vehicle may automatically brake moderately or hard. This front automatic braking can only occur if a vehicle ahead is detected ⇨ 169. On vehicles with front pedestrian protection, front automatic braking can also occur when a pedestrian ahead is detected.

Emergency automatic braking may slow the vehicle to a complete stop to try to avoid a potential crash. If this happens, emergency automatic braking may engage the electric parking brake to hold the vehicle at a stop. To release press the electric parking brake button or firmly press the accelerator pedal.

**⚠ Warning**

Emergency automatic braking is an emergency crash preparation feature and is not designed to avoid crashes. Do not rely on the system to brake the vehicle. Emergency automatic braking will not brake outside of its operating speed range and only responds to detected vehicles and pedestrians.

**Forward looking brake assist**

In addition to the brake preparation system and emergency automatic braking, the forward looking brake assist function makes the brake assist more sensitive. Therefore, pressing the brake pedal less strongly results in immediate hard braking. This function helps the driver brake quicker and harder before the imminent collision.

**⚠ Warning**

Active emergency braking is not designed to apply hard autonomous braking or to automatically avoid a collision. It is designed to reduce the vehicle speed before a collision. It may not react to animals. After a sudden lane change, the system needs a certain time to detect the next preceding vehicle.

The complete attention of the driver is always required while driving. The driver must always be ready to take action and apply the brakes and steer to avoid collisions.

The system is designed to work with all occupants wearing their seat belts.

**Intelligent Brake Assist**

If the vehicle is equipped with radar sensor Intelligent brake assist may activate when the brake pedal is applied quickly by providing a boost

to braking based on the speed of approach and distance to a vehicle ahead.

Minor brake pedal pulsations or pedal movement during this time is normal and the brake pedal should continue to be applied as needed. Intelligent brake assist will automatically disengage only when the brake pedal is released.

**⚠ Warning**

Intelligent brake assist may increase vehicle braking in situations when it may not be necessary. You could block the flow of traffic. If this occurs, take your foot off the brake pedal and then apply the brakes as needed.

**Forward collision alert**

⇨ 169

**Front pedestrian protection**

⇨ 173.

## Deactivation

Active emergency braking can be deactivated in the personalisation menu ⇨ 104. If deactivated a message is displayed in the Driver Information Centre.

## System limitations

In some cases, the active emergency braking system may provide an automatic braking in situations that seem to be unnecessary, for instance in parking garages, due to traffic signs in a curve or due to vehicles in another lane. This is normal operation, the vehicle does not need service. Firmly apply the accelerator pedal to override the automatic braking if the situation and the surroundings permit.

In the following cases, active emergency braking performance is limited:

- Driving on winding or hilly roads.
- Detecting all vehicles, especially vehicles with a trailer, tractors, muddy vehicles, etc.

- Detecting a vehicle when weather limits visibility, such as in fog, rain, or snow.
- During nighttime driving.
- Weather limits visibility, such as fog, rain, or snow.
- The sensor in the windscreen or the radar unit behind the front bumper are blocked by snow, ice, slush, mud, dirt etc.
- The windscreen is damaged or affected by foreign items, e.g. stickers.

Complete attention is always required while driving, and you should be ready to take action and apply the brakes and/or steer the vehicle to avoid crashes.

## Fault

In case the system requires a service, a message is displayed in the Driver Information Centre.

If the system does not work as it should do, vehicle messages are displayed in the Driver Information Centre.

Vehicle messages ⇨ 103.

## Front pedestrian protection

Front pedestrian protection may help to avoid or reduce the harm caused by front-end crashes with nearby pedestrians when driving in a forward gear.

The system uses the front camera in the windscreen and a radar unit in the front bumper to detect a pedestrian directly ahead, in your path.

Front pedestrian protection can detect and alert to pedestrians in a forward gear at speeds between 3 mph and 37 mph. Additionally Front pedestrian protection can provide a boost to braking or automatically brake the vehicle.

During nighttime driving, system performance is limited.

Front pedestrian protection can be set to Off, Alert, or Alert & Brake in vehicle personalisation ⇨ 104.

**⚠ Danger**

Front pedestrian braking does not provide an alert or automatically brake the vehicle, unless it detects a pedestrian.

The system may not detect pedestrians, including children, when the pedestrian is not directly ahead, not fully visible, not standing upright, or when part of a group.

Front pedestrian protection includes:

- detecting front pedestrian ahead
- front pedestrian alert

**Detecting front pedestrian ahead**

A pedestrian ahead up to a distance of approximately 40m is indicated by a symbol in the instrument cluster.

**Front pedestrian alert**

When approaching a detected pedestrian too quickly, a warning message is displayed in the Driver Information Centre. A warning chime is provided.

Cruise control or Adaptive cruise control may be disengaged when the front pedestrian alert occurs.

**System limitations**

In the following cases, front pedestrian protection may not detect a pedestrian ahead or sensor performance is limited:

- Vehicle speed is out of range from 3 mph to 37 mph in forward gear.
- The distance to an pedestrian ahead is more than 40 metres.
- Driving on winding or hilly roads.
- During nighttime driving.
- Weather limits visibility, such as fog, rain, or snow.
- The sensor in the windscreen or the radar unit behind the front bumper are blocked by snow, ice, slush, mud, dirt etc.
- The windscreen is damaged or affected by foreign items, e.g. stickers.

**Parking assist****General information**

When attaching a trailer or bike carrier to the trailer hitch, the parking assist is deactivated.

**⚠ Warning**

The driver bears full responsibility for the parking manoeuvre.

Always check the surrounding area when driving backwards or forwards while using parking assist system.

**Rear parking assist**

The rear parking assist makes parking easier by measuring the distance between the vehicle and rear obstacles. It informs and warns the driver by giving acoustic signals and display indication.





The system operates with ultrasonic parking sensors in the rear bumper.

### Activation

Rear parking assist is activated when reverse gear is engaged and ignition is switched on.



The system is ready to operate when the LED in the parking assist button  is not illuminated.

### Indication

The system warns the driver with acoustic signals against potentially hazardous obstacles behind the vehicle while reverse gear is engaged.

Depending on which side of the vehicle is closer to an obstacle, you will hear acoustic warning signals in the vehicle on the respective side. The interval between the sounds becomes shorter as the vehicle gets closer to that obstacle. When the distance is less than approx. 30 cm, the sound is continuous.



Additionally, the distance to rear obstacles is displayed by changing distance lines in the Info Display  101. When the obstacle is very close,  for Danger is displayed in the screen.

### Deactivation



The system is switched off when reverse gear is disengaged. Press  to deactivate the system manually. The LED in the button illuminates when the system is deactivated. If the system has been deactivated manually, it is not reactivated automatically the next time the ignition is switched on.

### Front-rear parking assist

The front-rear parking assist measures the distance between the vehicle and obstacles in front and

behind the vehicle. It informs and warns the driver by giving acoustic signals and display indication.

It uses two different acoustic warning signals for the front and rear monitoring areas, each with a different tone frequency.



The system operates with ultrasonic parking sensors in the rear and front bumper.

### Activation

In addition to the rear parking assist, the front parking assist is triggered when an obstacle is detected in front and the speed of the vehicle is still below 6 mph.



The system is ready to operate when the LED in the parking assist button **P OFF** is not illuminated.

When the system is deactivated, the LED in the button illuminates.

### Indication

The system warns the driver with acoustic signals against potentially hazardous obstacles in front of the vehicle and behind the vehicle.

Depending on which side of the vehicle is closer to an obstacle, you will hear acoustic warning signals in the vehicle on the respective side.

The interval between the sounds becomes shorter as the vehicle gets

closer to that obstacle. When the distance is less than approx. 30 cm, the sound is continuous.



Additionally, the distance to rear and front obstacles is displayed by changing distance lines in the Info-Display ↗ 101.

If the vehicle stops for more than three seconds in a forward gear, if automatic transmission is in **P** or if no further obstacles are detected, no acoustic warning signals are given.

### Deactivation

The system is deactivated automatically when vehicle speed exceeds 6 mph, by applying the electric parking brake or by pressing the parking assist button .

When the system is deactivated manually, the LED in the button illuminates.

If the system has been deactivated manually, it is not reactivated automatically the next time the ignition is switched on.

### System limitations

In the event of a fault or if the system does not work temporarily, e.g. because of high external noise level or other interference factors, **Service** in the cluster instrument illuminates. A message is indicated in the Driver Information Centre.

#### Warning

Under certain circumstances, various reflective surfaces on objects or clothing as well as

external noise sources may cause the system to fail to detect obstacles.

Special attention must be paid to low obstacles which can damage the lower part of the bumper.

#### Caution

Performance of the system can be reduced when sensors are covered, e.g. by ice or snow.

Performance of the parking assist system can be reduced due to heavy loading.

Special conditions apply if there are taller vehicles in the vicinity (e.g. off-road vehicles, mini vans, vans). Object identification and correct distance indication in the upper part of these vehicles cannot be guaranteed.

Objects with a very small reflection cross-section, e.g. objects of narrow size or soft materials, may not be detected by the system.

Parking assist systems do not detect objects outside the detection range.

### Advanced parking assist

#### Warning

The driver bears full responsibility for accepting the parking slot suggested by the system and the parking manoeuvre.

Always check the surrounding area in all directions when using the advanced parking assist.

The advanced parking assist measures a suitable parking slot while passing, calculates the trajectory and automatically steers the vehicle while parking.

Advanced parking assist provides assistance for the following manoeuvres:

- Entry into a parallel parking slot.
- Entry into a perpendicular parking slot.
- Exit from a parallel parking slot.

The driver must control acceleration, braking and gear shifting, while steering is done automatically. The driver can take control at any time by gripping the steering wheel.

It may be necessary to move forwards and backwards more than once.

Instructions are given in the Info-Display ↗ 101.

Advanced parking assist can only be activated when driving forwards.



Advanced parking assist is always combined with front-rear parking assist.

The system has six ultrasonic parking sensors each in both the rear and front bumper.

### Entry into a parallel parking slot

#### Activation

Slow down the vehicle speed below 12 mph.

7" Colour-Info-Display: to search for a parking slot, activate the system by selecting **Park Assist** on the homepage of the touch screen. Then select **Enter parallel parking space**.

8" Colour-Info-Display: to search for a parking slot, activate the system by pressing . Select Driving functions on the touch screen and then **Park Assist**. Select **Enter parallel parking space**.

Select parking side by switching on turn signal indicator on the respective side.

The allowed parallel distance between the vehicle and a row of parked cars is between 0.5 metres and 1.5 metres.

The system will not identify slots that are clearly smaller or larger than the vehicle.



When a free slot is detected, a visual feedback on the Colour-Info-Display and a first acoustic signal is given. Drive slowly forwards. When the second acoustic signal is given, stop the vehicle, select reverse gear, release the steering wheel and start moving slowly. A visual feedback is given in the Colour-Info-Display.

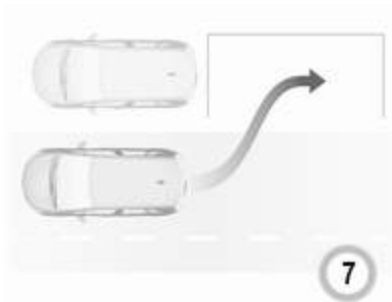

Move forwards and backwards while observing the warnings of the Parking assist until the end of manoeuvre is indicated.

### Entry into a perpendicular parking slot

#### Activation

7" Colour-Info-Display: to search for a parking slot, activate the system by selecting **Park Assist** on the homepage of the touch screen. Then select **Enter perpendicular parking space**.

8" Colour-Info-Display: when search for a parking slot, activate the system by pressing . Select Driving functions on the touch screen and then **Park Assist**. Select **Enter bay parking space**.

Slow down the vehicle speed below 12 mph.

Select parking side by switching on turn signal indicator on the respective side.

The allowed parallel distance between the vehicle and a row of parked cars is between 0.5 metres and 1.5 metres.

When several successive slots are found, the vehicle will be directed towards the last one.

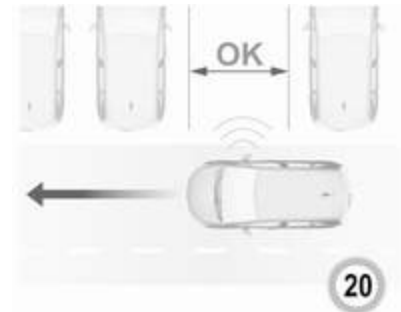

When a free slot is detected, a visual feedback on the Colour-Info-Display and an acoustic signal is given. Stop the vehicle, select reverse gear, release the steering wheel and start moving without exceeding 4 mph.

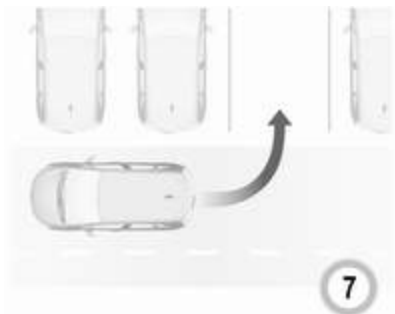

Move forwards and backwards as instructed by observing the warnings of the Parking assist and paying attention to the acoustic signals until the end of manoeuvre is indicated. When finished,  $\text{P}$  extinguishes in the instrument cluster.

During the parking manoeuvre, the system is automatically deactivated once the rear of the vehicle is within 50 cm of an obstacle.

## Exiting a parallel parking slot

### Activation

7" Colour-Info-Display: when exiting a parallel parking slot, activate the system by selecting **Park Assist** on the homepage of the touch screen. Then select **Exit parallel parking space**.

8" Colour-Info-Display: when exiting a parallel parking slot, activate the system by pressing  $\text{P}$ . Select Driving functions on the touch screen and then **Park Assist**. Select **Exit parallel parking space**.

Select exit side by switching on the respective turn signal indicator.

Engage reverse or forward gear, release the steering wheel and start moving without exceeding 3 mph.



Move forwards and backwards while observing the warnings of the Parking assist until the end of manoeuvre is indicated. The manoeuvre is complete when the vehicle's front wheels are out of the parking slot.

After deactivation check control over the vehicle.

### Display indication

The instructions on the display show:

- General hints and warning messages.
- The demand to stop the vehicle, when a parking slot is detected.

- The direction of driving during the parking manoeuvre.
- The demand to shift into reverse or first gear.
- The demand to stop or to drive slowly.
- The successful completion of the parking manoeuvre indicated by a pop-up symbol and a chime.
- The cancelling of a parking manoeuvre.

## Deactivation

The current park assist manoeuvre is cancelled via the button to return to the previous screen in the Colour-Info-Display. To deactivate the system completely, press  in the centre console.

The system is deactivated automatically:

- if the ignition is switched off
- if stalling the engine
- if no manoeuvre is started within 5 minutes of selection of the type of manoeuvre

- after a prolonged stop of the vehicle during a manoeuvre
- if the electronic stability control (ESC) is triggered
- if the speed of the vehicle exceeds the stated limit
- when the driver interrupts movement of the steering wheel
- after 4 manoeuvre cycles (a manoeuvre cycle consists of one rear move and one forward move)
- on opening the driver's door
- if one of the front wheels encounters an obstacle
- parking manoeuvre successfully ended

Deactivation by the driver or by the system during manoeuvring will be indicated on the display. Additionally, an acoustic signal sounds.

The system is switched off automatically when towing a electrically connected trailer.

Contact your dealer to switch off the system for a prolonged period.

## Fault

In the event of a fault, a message is displayed in the Colour Info Display, accompanied by an acoustic signal.

In the event of a fault in the power steering,  illuminates and a message is displayed in the Driver Information Centre.

### Warning

Under certain circumstances, various reflective surfaces on objects or clothing as well as external noise sources may cause the system to fail to detect obstacles.

Special attention must be paid to low obstacles which can damage the lower part of the bumper.

**Caution**

Performance of the system can be reduced when sensors are covered, e.g. by ice or snow.

Performance of the parking assist system can be reduced due to heavy loading.

Special conditions apply if there are taller vehicles in the vicinity (e.g. off-road vehicles, mini vans, vans). Object identification and correct distance indication in the upper part of these vehicles cannot be guaranteed.

Objects with a very small reflection cross-section, e.g. objects of narrow size or soft materials, may not be detected by the system.

Parking assist systems do not detect objects outside the detection range.

**Notice**

It is possible that the sensor detects a non-existing object caused by echo disturbance from external

acoustic noise or mechanical misalignments (sporadic false warnings may occur).

Make sure that the front number plate is properly mounted (not bent and no gaps to the bumper on the left or right side) and the sensors are firmly in place.

Advanced parking assist system may not respond to changes in the available parking space after initiating a parking manoeuvre. The system may recognize an entry, a gateway, a courtyard or even a crossing as a parking slot. After selecting reverse gear the system will start a parking manoeuvre. Take care regarding the availability of the suggested parking slot.

Surface irregularities, e.g. on construction zones, are not detected by the system. The driver accepts responsibility.

**Side blind spot alert**

The Side blind spot alert system detects and reports objects on either side of the vehicle, within a specified "blind spot" zone. The system

displays a visual alert in each exterior mirror, when detecting objects that may not be visible in the interior and exterior mirrors.

Side blind spot alert uses some of the advanced parking assist sensors which are located in the front and rear bumper on both sides of the vehicle.

**Warning**

Side blind spot alert does not replace driver vision.

The system does not detect:

- vehicles outside the side blind zones which may be rapidly approaching
- pedestrians, cyclists or animals

Before changing a lane, always check all mirrors, look over the shoulder and use the turn signal.

**Activation**

7" Colour-Info-Display: select **Blind spot monitoring** on the homepage of the touch screen and activate the function.



8" Colour-Info-Display: press . Select Driving functions on the touch screen and then **Blind spot monitoring**. Activate the function.

 illuminates continuously green in the instrument cluster to confirm the function.

### Functionality

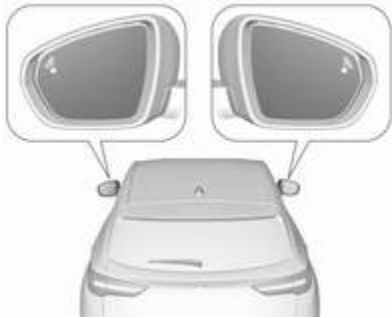

When the system detects a vehicle in the side blind zone while driving forwards, a round LED will illuminate in the relevant exterior mirror.

The LED comes on immediately when being passed.

The LED comes on after a delay when passing another vehicle slowly.

### Operation conditions



The following conditions must be fulfilled for proper operation:

- All vehicles are moving in the same direction and in adjacent lanes.
- The speed of your vehicle is between 7 and 87 mph.
- Passing a vehicle with a speed difference of less than 6 mph.
- Another vehicle is passing with a speed difference of less than 15 mph.
- The traffic flow is normal.
- Driving on a straight or slightly curved road.
- The vehicle is not pulling a trailer.

No alert will be given in the following situations:

- In the presence of non-moving objects (parked vehicles, barriers, street lamps, road signs...).
- With vehicles moving in the opposite direction.
- Driving on a winding road or a sharp corner.
- When passing (or being passed by) a very long vehicle (lorry, coach...) which is at the same time detected at the rear in the blind spot angle and present in the driver's forward field of vision.
- In very heavy traffic: vehicles detected in front and behind are confused with a lorry or a stationary object.
- When passing too quickly.

### Deactivation

The system is deactivated in the vehicle personalisation  104.  extinguishes in the instrument cluster. Additionally, an acoustic signal sounds.

The state of the system is stored when switching off the ignition.

The system is automatically deactivated when towing an electrically connected trailer.

Due to adverse weather conditions such as heavy rain, false detections may occur.

### Fault

In the event of a fault,  flashes for a few moments in the instrument panel, accompanied by **SERVICE** and a display message. Contact a dealer or a qualified workshop to have the system checked.

### Panoramic view system

This system allows views of the vehicle's surroundings to be displayed as a nearly 360° picture in the Info display, like a bird's eye view.

The system uses:

- rear camera, installed in the tailgate
- ultrasonic parking sensors in the rear bumper

- front camera, installed in the front grill below the emblem
- ultrasonic parking sensors in the front bumper

The screen in the Info display is divided into two parts: on the right there is a view from above the vehicle, and on the left there is the view from the rear or the front displayed. The parking sensors complete the information on the view from above the vehicle.

### Activation

The panoramic view system is activated by:

- engaging a gear or gearbox in a neutral position (front view)
- engaging reverse gear (rear view)
- manually in the view selection menu
- approaching too close to an object ahead
- driving up to 12 mph

Vehicle personalisation ⇨ 104

### Functionality



Different views can be selected in the left part of the display. Change the type of view at any time during a manoeuvre by pressing the touch field in the left lower zone of the display and selecting a view from the view selection menu:

- Standard view
- Auto mode
- Zoom view
- 180° view

The display is immediately updated with the type of view selected.

AUTO mode is activated by default. In this mode, the system selects the best view, standard, or zoom, to display according to the information from the parking sensors.

The state of the system is not kept in memory when the ignition is switched off.

### Standard view

The Standard view consists of a rear view and a front view.

### Rear view



The area behind the vehicle is displayed in the screen. The vertical lines represent the width of the

vehicle with mirrors unfolded. The direction of the lines changes with the position of the steering wheel.

The first horizontal line represents a distance of about 30 cm beyond the edge of vehicle's rear bumper. The upper horizontal lines represent distances of about one and two metres beyond the edge of your vehicle's rear bumper.

This view is available in AUTO mode or in the view selection menu.

### Front view

The area in front the vehicle is displayed in the screen. The vertical lines represent the width of the vehicle with mirrors unfolded. The direction of the lines changes with the position of the steering wheel.

The first horizontal line represents a distance of about 30 cm beyond the edge of vehicle's front bumper. The upper horizontal lines represent distances of about one and two metres beyond the edge of your vehicle's front bumper.

This view is available in AUTO mode or in the view selection menu.

### Auto mode

This mode is activated by default. Using sensors in the rear or in the front bumper, the automatic view changes from rear view or front view to a view from above, as an obstacle is approached during a manoeuvre.

### Zoom view



The camera records the vehicle's surroundings during the manoeuvre in order to reconstruct a view from above the rear or the front of the vehicle in its near surroundings, allowing the vehicle to be manoeuvred around obstacles

nearby. This view is available with AUTO mode or in the view selection menu.

**180° view**



The 180° view facilitates reversing out of a parking bay, making it possible to see the approach of vehicles, pedestrians and cyclists. This view is not recommended for carrying out a complete manoeuvre. It is made up of three areas: left 1, centre 2 and right 3. This view is available from the view selection menu only.

**Deactivation**

Panoramic view system is deactivated when:

- driving faster than 18 mph
- seven seconds after disengaging reverse gear
- by pressing the icon ⊗ in the left upper corner of the touch screen
- opening the tailgate

**General information**

**⚠ Warning**

The panoramic view system does not replace driver vision. It will not display children, pedestrians, cyclists, crossing traffic, animals, or any other objects outside of the camera view area, e. g. below the bumper, or underneath the vehicle.

Do not drive or park the vehicle using only the panoramic view system.

Always check the surrounding of the vehicle before driving.

Displayed images may be further or closer than they appear. The area displayed is limited and objects that are close to either edge of the bumper or under the bumper are not displayed on the screen.

**System limitations**

**Caution**

For optimal operation of the system, it is important to keep the lens of the camera in the tailgate between the number plate lights and the lens in the front grill below the emblem always clean. Rinse the lenses with water and wipe with a soft cloth.

Do not clean the lenses with a steam-jet or high-pressure jet cleaner.

The panoramic view system may not operate properly when:

- The surrounding is dark.
- The sun or the beam of headlights is shining directly into the camera lenses.
- During nighttime driving.
- Weather limits visibility, such as fog, rain, or snow.
- The camera lenses are blocked by snow, ice, slush, mud, dirt.
- The vehicle is towing a trailer.
- The vehicle had an accident.
- There are extreme temperature changes.

## Rear view camera

The rear view camera assists the driver when reversing by displaying a view of the area behind the vehicle.

The view of the camera is displayed in the Info-Display.

### Warning

The rear view camera does not replace driver vision. Note that objects that are outside the camera's field of view and the parking assist sensors, e.g. below the bumper or underneath the vehicle, are not displayed.

Do not reverse or park the vehicle using only the rear view camera.

Always check the surrounding of the vehicle before driving.

### Switching on

Rear view camera is automatically activated when reverse gear is engaged.

### Functionality



The camera is mounted in the tailgate.

The area displayed by the camera is limited. The distance of the image that appears on the display differs from the actual distance.

## Guide lines

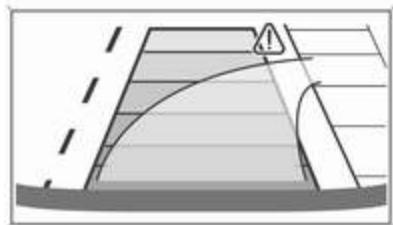

The vertical lines represent the general direction of the vehicle and the distance between the vertical lines corresponds to the width of your vehicle without mirrors. Red markers represent 50 cm from the rear bumper edge. The first complete horizontal line represents a distance of about 1m. The distance between each complete horizontal line represents 1m. The last complete horizontal line represents 5m.

## Deactivation of guide lines

Guide lines can be deactivated in the Info-Display. Select **Settings**, **Vehicle**, **Collision detection**, **Rear view camera guide lines**, **O**.

Info-Display ⇨ 101.

Vehicle personalisation ⇨ 104.

## Switching off

The camera is switched off when a forward gear is engaged.

## System limitations

The rear view camera may not operate properly when:

- The surrounding is dark.
- The beam of headlights is shining directly into the camera lenses.
- During nighttime driving.
- Weather limits visibility, such as fog, rain, or snow.
- The camera lenses are blocked by snow, ice, slush, mud, dirt. Clean the lense, rinse with water, and wipe with a soft cloth.
- The tailgate will be opened.

- The vehicle is towing an electrically connected trailer.
- The vehicle had a rear end accident.
- There are extreme temperature changes.

## Lane departure warning

The lane departure warning system observes the lane markings between which the vehicle is driving via a front camera located at the top of the windscreen. The system detects lane changes and warns the driver in the event of an unintended lane change via visual and acoustic signals.

Criteria for the detection of an unintended lane change are:



- No operation of turn signals.
- No brake pedal operation.
- No active accelerator operation or speeding-up.

### ⚠ Warning

This system is a driving aid that cannot, in any circumstances, replace the need for vigilance on the part of the driver.

### Activation





After ignition is switched on, the lane departure warning system is activated. If the system is activated, the LED in the button  is not illuminated. To activate the system when the system is deactivated, press .

The system is only operable at vehicle speeds above 37 mph and if lane markings are available.

When the system recognises an unintended lane change, the control indicator  flashes yellow. Simultaneously a chime sound is activated.



### Deactivation

The system is deactivated by pressing . If the system is deactivated, the LED in the button  illuminates.

At speeds below 37 mph the system is inoperable.

### Fault

In the event of a fault,  appears in the instrument panel, accompanied by a display message. Contact a dealer or a qualified workshop to have the system checked.

### System limitations

The system performance may not operate properly when:

- Vehicle speed is below 37 mph.
- Windscreen is not clean or affected by foreign items, e.g. stickers
- Driving on winding or hilly roads.
- During nighttime driving.
- Adverse environmental conditions like heavy rain, snow, direct sunlight or shadows.
- The sensor in the windscreen is blocked by snow, ice, slush, mud, dirt, windscreen damage or affected by foreign items, e.g. stickers.
- The sun is shining directly into the camera lens.
- Close vehicles ahead.

- Driving on banked roads.
- Driving on road edges.
- Driving on roads with poor lane markings.
- Sudden lighting changes.

The system can not operate when no lane marking is detected.

### Lane keep assist

Lane keep assist helps to avoid crashes due to unintentional lane departures. The front camera observes the lane markings between which the vehicle is driving. If the vehicle approaches a lane marking, the steering wheel is gently turned to position the vehicle back into the lane. Turn steering wheel in same direction, if system steers not sufficient. Turn steering wheel gently into opposite direction, if lane change is intended.

When crossing a lane marking significantly, lane keep assist starts a visual and acoustic warning.

Unintended lane departure is assumed

- without using turn signal
- without braking
- without acceleration
- without active steering.

#### Notice



The system is switched off during detection of ambiguous lane markings, e.g. in construction areas.

#### Notice

The system may be switched off if it detects lanes which are too narrow, too wide or too curved.

### Activation



After ignition is switched on, lane keep assist is activated. If the system is activated, the LED in the button  is not illuminated. To activate the system when the system is deactivated, press .

When the control indicator  in the instrument cluster illuminates green, the system is ready to assist.

The system is operational at vehicle speeds between 40 mph and 112 mph and if lane markings are available. The driver must hold the wheel with both hands. The change of trajectory is not accompanied by operation of the direction indicators. The ESC system must be activated.

The system makes the correction to the trajectory necessary to return the vehicle to its initial path if it identifies a risk of the vehicle involuntarily crossing one of the lane markings detected. The driver will then notice a turning movement of the steering wheel.



The control indicator  flashes during trajectory correction. In the Driver Information Centre, the line of the corrected side will be displayed in orange.

If the driver wishes to maintain the trajectory of the vehicle, he can prevent the correction by keeping a firm grip on the wheel (during an avoiding manoeuvre, for example). The correction is interrupted if the direction indicators are operated.

While the direction indicators are on and for a few seconds after switching them off, the system considers that any change of trajectory is voluntary and no correction is triggered during this period.

If the system detects that the driver is not holding the wheel firmly enough during an automatic correction of trajectory, it interrupts the correction. An alert is triggered to encourage the driver to take back control of the vehicle.

## Deactivation

The system is deactivated by pressing  during a few seconds; the LED in the button illuminates. In the Driver Information Centre, solid grey lines are displayed.

## Fault

The system performance may be affected by:

- Windscreen not clean or affected by foreign items, e.g. stickers
- Close vehicles ahead
- Banked roads
- Winding or hilly roads
- Road edges
- Roads with poor lane markings
- Sudden lighting changes
- Adverse environmental conditions e.g. heavy rain or snow
- Vehicle modifications, e.g. tyres.

Switch off the system if the system is disturbed by tar marks, shadows, road cracks, temporary or construction lane markings, or other road imperfections.

## Warning

Always keep your attention on the road and maintain proper vehicle position within the lane, otherwise vehicle damage, injury or death could occur.

Lane keep assist does not continuously steer the vehicle.

The system may not keep the vehicle in the lane or give an alert, even if a lane marking is detected.

The steering of the lane keep assist may not be sufficient to avoid a lane departure.

The system may not detect hands-off driving due to external influences (road condition and surface, weather etc). The driver has full responsibility to control the

vehicle and is always required to keep the hands on the steering wheel while driving.

Using the system while towing a trailer or on slippery roads could cause loss of control of the vehicle and a crash. Switch the system off.

## Driver alert

The driver alert system monitors the driving time and the vigilance of the driver. Monitoring the vigilance of the driver is based on the trajectory variations of the vehicle compared to the lane markings.

The system includes a driving time alert combined with driver drowsiness detection.

### **Warning**

The system cannot replace the need for vigilance on the part of the driver. It is recommended that you take a break as soon as you feel tired or at least every two hours. Do not take the wheel if you are tired.

## Activation or Deactivation

The system can be activated or deactivated in the vehicle personalisation ⇨ 104

The state of the system stays in memory when the ignition is switched off.

## Driving time alert

The driver gets notified by a pop-up reminder symbol  in the Driver Information Centre simultaneously with a acoustic alert if the driver has not taken a break after two hours of driving at a speed above 40 mph. The alert is repeated hourly until the vehicle is stopped, no matter how vehicle speed evolves.

The counting of driving time alert is reset when the ignition has been switched off for a few minutes.

## Driver drowsiness detection

The system monitors the driver's level of vigilance. A camera at the top of the windscreen detects variations in trajectory compared to the lane

markings. This system is particularly suited to fast roads (speed higher than 40 mph).

If the trajectory of the vehicle suggests a certain level of drowsiness or inattention by the driver, the system triggers the first level of alert. The driver is notified by a message and an audible signal is given.

After three first level alerts, the system triggers a new alert with a message, accompanied by a more pronounced audible signal.

In certain driving conditions (poor road surface or strong winds), the system may give alerts independent of the driver's level of vigilance.

The driver drowsiness detection is reinitialised when the ignition has been switched off for a few minutes or the speed remains below 40 mph for a few minutes.

## System limitations

In the following situations, the system may not operate properly or even not operate at all:

- Poor visibility caused by inadequate lighting of the roadway, falling snow, heavy rain, dense fog etc.
- Dazzle caused by headlamps of an oncoming vehicles, low sun, reflections on damp roads, leaving a tunnel, alternating shade and light etc.
- Windscreen area in front of the camera covered by dirt, snow, stickers etc.
- No lane markings detected or multiple lane markings due to roadworks
- Close vehicles ahead
- Winding roads or narrow roads

## Fuel

### Fuel for petrol engines

Only use unleaded fuel that complies with European standard EN 228 or E DIN 51626-1 or equivalent.

The engine is capable of running with fuel that contains up to 10% ethanol (e.g. named E10).

Use fuel with the recommended octane rating. A lower octane rating can reduce engine power and torque and slightly increases fuel consumption.

#### Caution

Do not use fuel or fuel additives that contain metallic compounds such as manganese-based additives. This may cause engine damage.

#### Caution

Use of fuel that does not comply to EN 228 or E DIN 51626-1 or equivalent can lead to deposits or engine damage.

#### Caution

Use of fuel with a lower octane rating than the lowest possible rating could lead to uncontrolled combustion and engine damage.

The engine specific requirements regarding octane rating are given in the engine data overview ↗ 243. A country-specific label at the fuel filler flap can supersede the requirement.

### Fuel additives outside Europe

Fuel should contain detergent additives that help prevent engine and fuel system deposits from forming. Clean fuel injectors and intake valves will allow the emission control system to work properly.



Some fuel does not contain sufficient quantities of additive to keep fuel injectors and intake valves clean.

To make up for this lack of detergency, add Fuel System Treatment PLUS to the fuel tank at every engine oil change or every 6,000 miles, whichever occurs first. It is available at your workshop.

Fuels containing oxygenates such as ethers and ethanol, as well as reformulated fuel, are available in some cities. If these fuels comply with the previously described specification, then they are acceptable to use. However, E85 (85% ethanol) and other fuels containing more than 15% ethanol must be used only in FlexFuel vehicles.

**Caution**

Do not use fuel containing methanol. It can corrode metal parts in the fuel system and also damage plastic and rubber parts. This damage would not be covered by the vehicle warranty.

Some fuels, mainly high octane racing fuels, can contain an octane enhancing additive called methylcyclopentadienyl manganese tricarbonyl (MMT). Do not use fuels or fuel additives with MMT as they can reduce spark plug life and affect emission control system performance. The malfunction indicator light  may turn on  94. If this occurs, seek the assistance of a workshop.

**Fuel for diesel engines**

Only use diesel fuel that complies with EN 590.

In countries outside the European Union use Euro-Diesel fuel with a sulfur concentration below 50 ppm.

**Caution**

Use of fuel that does not comply to EN 590 or similar can lead to engine powerloss, increased wear or engine damage.

Do not use marine diesel oils, heating oils, Aquazole and similar diesel-water emulsions. Diesel fuels must not be diluted with fuels for petrol engines.

**Low temperature operation**

At temperatures below 0° C, some diesel products with biodiesel blends may clog, freeze or gel, which may affect the fuel supply system. Starting and engine operation may not work properly. Make sure to fill winter grade diesel fuel at ambient temperatures below 0°C.

Arctic grade diesel fuel can be used in extreme cold temperatures below -20° C. Using this fuel grade in warm or hot climates is not recommended and may cause engine stalling, poor starting or damage on the fuel injection system.

## Refuelling



### **⚠ Danger**

Before refuelling, switch off ignition and any external heaters with combustion chambers.

Follow the operating and safety instructions of the filling station when refuelling.

### **⚠ Danger**

Fuel is flammable and explosive. No smoking. No naked flames or sparks.

If you can smell fuel in your vehicle, have the cause of this remedied immediately by a workshop.

### **Caution**

In case of misfuelling, do not switch on ignition.

Fuel filler flap is located at right rear side of vehicle.



The fuel filler flap can only be opened if the vehicle is unlocked. Release the fuel filler flap by pushing the flap.

### **Petrol and Diesel refuelling**

To open, turn the cap slowly anticlockwise.



The fuel filler cap can be attached to the hook on the fuel filler flap.

To refuel, fully insert the pump nozzle and switch it on.

After the automatic cut-off, the tank can be topped up by operating the pump nozzle a maximum of two more times.

### Caution

Wipe off any overflowing fuel immediately.

To close, turn the fuel filler cap clockwise until it clicks.

Close the flap and allow it to engage.

## Fuel filler cap

Only use genuine fuel filler caps.

Diesel-engined vehicles have special fuel filler caps.

## Fuel consumption - CO<sub>2</sub>-Emissions

The value of the fuel consumption (combined) of the model Vauxhall Grandland X is within a range of 51.4 to 65.7 mpg.

The value of the CO<sub>2</sub> emission (combined) is within a range of 127 to 111 g/km.

For the values specific for your vehicle, refer to the EEC Certificate of Conformity provided with your vehicle or other national registration documents.

## General information

The official fuel consumption and specific CO<sub>2</sub> emission figures quoted relate to the EU base model with standard equipment.

Fuel consumption data and CO<sub>2</sub> emission data are determined according to regulation R (EC) No. 715/2007 (in the version respectively applicable), taking into consideration the vehicle weight in running order, as specified by the regulation.

The figures are provided only for the purpose of comparison between different vehicle variants and must not be taken as a guarantee for the actual fuel consumption of a particular vehicle. Additional equipment may result in higher results than the stated consumption and CO<sub>2</sub> figures. Furthermore, fuel consumption is dependent on personal driving style as well as road and traffic conditions.

## Trailer hitch

### General information

Only use towing equipment that has been approved for your vehicle. Vehicles with natural gas engines require special towing equipment.

Entrust retrofitting of towing equipment to a workshop. It may be necessary to make changes that affect the cooling system, heat shields or other equipment.

The bulb outage detection function for trailer brake light cannot detect a partial bulb outage. E.g. in case of 4x 5 Watt bulbs, the function only detects lamp outage when only a single 5 Watt lamp remains or none remain.

Fitting of towing equipment could cover the opening of the towing eye. If this is the case use the coupling ball bar for towing. Always keep the coupling ball bar in the vehicle.

### Driving characteristics and towing tips

Before attaching a trailer, lubricate the coupling ball. However, do not do so if a stabiliser, which acts on the coupling ball, is being used to reduce snaking movements.

During trailer towing do not exceed a speed of 50 mph. A maximum speed of 60 mph is only appropriate if an oscillation damper is used and the permissible gross trailer weight does not exceed the vehicle's curb weight.

For trailers with low driving stability and caravan trailers, the use of an oscillation damper is strongly recommended.

If the trailer starts snaking, drive more slowly, do not attempt to correct the steering and brake sharply if necessary.

When driving downhill, drive in the same gear as if driving uphill and drive at a similar speed.

Adjust tyre pressure to the value specified for full load ↪ 247.

### Trailer towing

#### Trailer loads

The permissible trailer loads are vehicle and engine-dependent maximum values which must not be exceeded. The actual trailer load is the difference between the actual gross weight of the trailer and the actual coupling socket load with the trailer coupled.

The permissible trailer loads are specified in the vehicle documents. In general, they are valid for gradients up to 12%.

The permissible trailer load applies up to the specified incline and at sea level. Since engine power decreases as altitude increases due to the air becoming thinner, therefore reducing climbing ability, the permissible gross train weight also decreases by 10% for every 1000 metres of altitude. The gross train weight does not have to be reduced when driving on roads with slight inclines (less than 8%, e.g. motorways).

The permissible gross train weight must not be exceeded. This weight is specified on the identification plate ↪ 238.

### Vertical coupling load

The vertical coupling load is the load exerted by the trailer on the coupling ball. It can be varied by changing the weight distribution when loading the trailer.

The maximum permissible vertical coupling load (70 kg) is specified on the towing equipment identification plate and in the vehicle documents.

Always aim for the maximum load, especially in the case of heavy trailers. The vertical coupling load should never fall below 25 kg.

### Rear axle load

When the trailer is coupled and the towing vehicle fully loaded, the permissible rear axle load (see identification plate or vehicle documents) may be exceeded by 60 kg, the gross vehicle weight rating may be exceeded by 60 kg. If the permissible rear axle load is exceeded, a maximum speed of 60 mph applies.

### Towing equipment

Caution
When operating without a trailer, remove the coupling ball bar.

### Fitting the coupling ball bar



Disengage and fold down the socket. Remove the sealing plug from the opening for the coupling ball bar and stow it.



### Checking the tensioning of the coupling ball bar



- Red marking on rotary knob must point towards green marking on coupling ball bar.
- The gap between the rotary knob and the coupling ball bar must be approx. 6 mm.

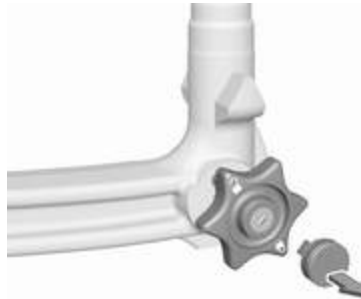

- Remove the cover from the lock of the rotary knob and verify whether the rotary knob is locked. If the rotary knob cannot be turned, it is locked.

Otherwise, the coupling ball bar must be tensioned before being inserted:

- Unlock coupling ball bar by turning key to position .



- Pull out rotary knob and turn clockwise as far as it will go.

### Inserting the coupling ball bar

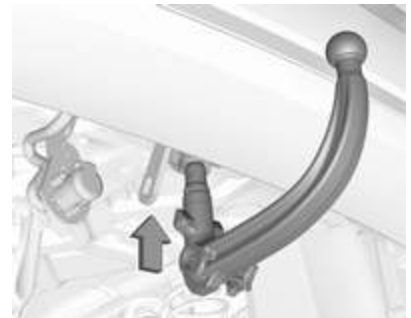

Insert the tensioned coupling ball bar in the opening and push firmly upwards until it audibly engages.

The rotary handle snaps back into its original position resting against the coupling ball bar without a gap.

**⚠ Warning**

Do not touch rotary handle during insertion.

Lock the coupling ball bar by turning the key to position . Remove the key and close the protective flap.

**Eye for break-away stopping cable**

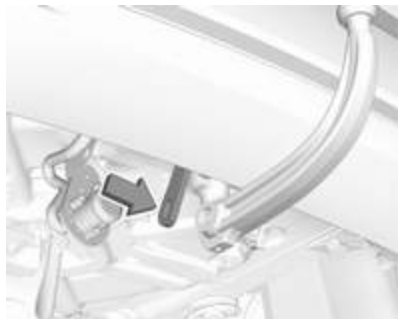

Attach breakaway stopping cable to eye.

**Check that the coupling ball bar is correctly installed**

- Green marking on rotary knob must point towards green marking on coupling ball bar.
- There must be no gap between the rotary handle and the coupling ball bar.
- The coupling ball bar must be firmly engaged in the opening.
- The coupling ball bar must be locked and the key removed.

**⚠ Warning**

Towing a trailer is permitted only when a coupling ball bar is fitted correctly. If the coupling ball bar does not engage correctly, seek the assistance of a workshop.

**Dismounting the coupling ball bar**



Open the protective flap and turn the key to position  to unlock the coupling ball bar.

Pull out rotary handle and turn clockwise as far as it will go. Pull out coupling ball bar downwards.

Insert sealing plug in opening. Fold away socket.

**Trailer stability assist**

If the system detects snaking movements, engine power is reduced and the vehicle/trailer combination is

---

selectively braked until the snaking ceases. While system is working keep steering wheel as still as possible.

Trailer stability assist (TSA) is a function of the Electronic Stability Control ↪ 153.

## Vehicle care

<b>General Information</b> .....	<b>202</b>
Accessories and vehicle modifications .....	202
Vehicle storage .....	203
End-of-life vehicle recovery .....	204
<b>Vehicle checks</b> .....	<b>204</b>
Performing work .....	204
Bonnet .....	204
Engine oil .....	205
Engine coolant .....	206
Washer fluid .....	207
Brakes .....	207
Brake fluid .....	207
Vehicle battery .....	207
Diesel fuel system bleeding .....	209
Wiper blade replacement .....	209
<b>Bulb replacement</b> .....	<b>210</b>
Halogen headlights .....	210
LED headlights .....	211
Fog lights .....	211
Tail lights .....	212
Side turn signal lights .....	215
Number plate light .....	215
Interior lights .....	215
Instrument panel illumination .....	215

<b>Vehicle tools</b> .....	<b>216</b>
Tools .....	216
<b>Wheels and tyres</b> .....	<b>217</b>
Winter tyres .....	217
Tyre designations .....	217
Tyre pressure .....	217
Tyre deflation detection system .....	218
Tread depth .....	219
Changing tyre and wheel size .....	220
Wheel covers .....	220
Tyre chains .....	221
Tyre repair kit .....	221
Wheel changing .....	224
Spare wheel .....	227
<b>Jump starting</b> .....	<b>228</b>
<b>Towing</b> .....	<b>229</b>
Towing the vehicle .....	229
Towing another vehicle .....	230
<b>Appearance care</b> .....	<b>231</b>
Exterior care .....	231
Interior care .....	233

## General Information

### Accessories and vehicle modifications

We recommend the use of genuine parts and accessories and factory approved parts specific for your vehicle type. We cannot assess or guarantee reliability of other products - even if they have a regulatory or otherwise granted approval.

Any modification, conversion or other changes made to standard vehicle specifications (including, without limitation, software modifications, modifications of the electronic control units) may invalidate the warranty offered by Vauxhall. Furthermore, such changes may affect driver assistance systems, may impact fuel consumption, CO<sub>2</sub> emissions and other emissions of the vehicle and cause the vehicle to no longer conform to the operating permit, impacting the validity of your vehicle registration.

**Caution**

When transporting the vehicle on a train or on a recovery vehicle, the mud flaps might be damaged.

**Cold protection covers**

In order to prevent the accumulation of snow at the radiator cooling fan, it is recommended to install removable protection covers.

Contact your dealer to install the protection covers.

**Caution**

The protection covers must be removed when one of the following conditions occur:

- The ambient temperature is above 10° C.
- When the vehicle is towed.
- The vehicle is driven at speeds above 75 mph.

**Vehicle storage****Storage for a long period of time**

If the vehicle is to be stored for several months:

- Wash and wax the vehicle.
- Have the wax in the engine compartment and underbody checked.
- Clean and preserve the rubber seals.
- Fill up fuel tank completely.
- Change the engine oil.
- Drain the washer fluid reservoir.
- Check the coolant antifreeze and corrosion protection.
- Adjust tyre pressure to the value specified for full load.
- Park the vehicle in a dry, well ventilated place. Engage first or reverse gear or set selector lever to **P**. Prevent the vehicle from rolling.
- Do not apply the parking brake.

- Open the bonnet, close all doors and lock the vehicle.
- Disconnect the clamp from the negative terminal of the vehicle battery. Beware that all systems are not functional, e.g. anti-theft alarm system.

**Putting back into operation**

When the vehicle is to be put back into operation:

- Connect the clamp to the negative terminal of the vehicle battery. Activate the electronics of the power windows.
- Check tyre pressure.
- Fill up the washer fluid reservoir.
- Check the engine oil level.
- Check the coolant level.
- Fit the number plate if necessary.

## End-of-life vehicle recovery

Information on end-of-life vehicle recovery centres and the recycling of end-of-life vehicles is available on our website, where legally required. Only entrust this work to an authorised recycling centre.

## Vehicle checks

### Performing work



#### **⚠ Warning**

Only perform engine compartment checks when the ignition is off.

The cooling fan may start operating even if the ignition is off.

#### **⚠ Danger**

The ignition system uses extremely high voltage. Do not touch.

## Bonnet

### Opening

Open the driver's door.

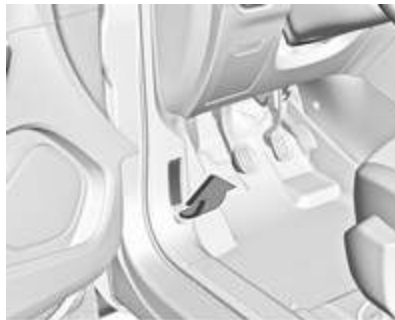

Pull the release lever and return it to its original position.



Push the safety catch upwards and open the bonnet.



Secure the bonnet support.

If the bonnet is opened during an Autostop, the engine will be restarted automatically for safety reasons.

Stop-start system ⇨ 139.

### Closing

Before closing the bonnet, press the support into the holder.

Lower the bonnet and let it fall into the latch from a low height (20-25 cm). Check that the bonnet is engaged.

### Caution

Do not press the bonnet into the latch to avoid dents.

### Engine oil

Check the engine oil level manually on a regular basis to prevent damage to the engine. Ensure that the correct specification of oil is used.

Recommended fluids and lubricants ⇨ 235.

The maximum engine oil consumption is 0.6 litres per 600 miles.

Check with the vehicle on a level surface. The engine must be at operating temperature and switched off for at least five minutes.

### Caution

It is the owner's responsibility to maintain the proper level of an appropriate quality oil in the engine.

Pull out the dipstick, wipe it clean, insert it to the stop on the handle, pull out and read the engine oil level.

Insert the dipstick to the stop on the handle.

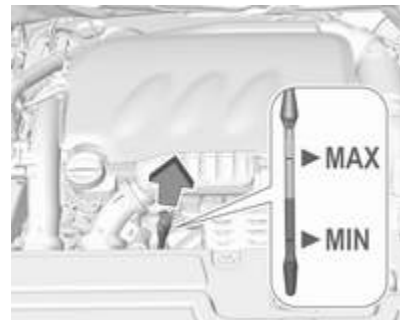

When the engine oil level has dropped to the **MIN** mark, top up the engine oil.

Different dipsticks are used depending on engine variant.

We recommend the use of the same grade of engine oil that was used at last change.



The engine oil level must not exceed the **MAX** mark on the dipstick.

**Caution**

Overfilled engine oil must be drained or suctioned out.

Capacities ⇨ 245.

Fit the cap on straight and tighten it.

**Engine coolant**

The coolant provides freeze protection down to approx. -37 °C.

**Caution**

Only use approved antifreeze.

Coolant and antifreeze ⇨ 235.

**Coolant level**

**Caution**

Too low a coolant level can cause engine damage.

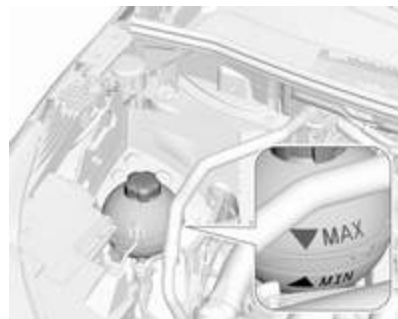

If the cooling system is cold, the coolant level should be above the **MIN** mark. Top up if the level is low.

**⚠ Warning**

Allow the engine to cool before opening the cap. Carefully open the cap, relieving the pressure slowly.

To top up, use a 1:1 mixture of released coolant concentrate mixed with clean tap water. If no coolant concentrate is available, use clean tap water. Install the cap tightly. Have



the coolant concentration checked and have the cause of the coolant loss remedied by a workshop.

## Washer fluid

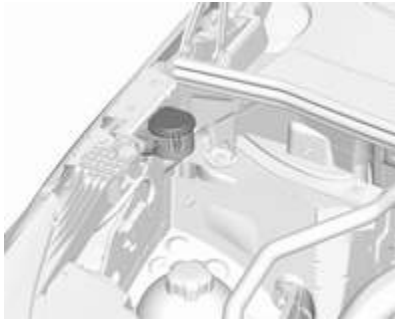

Fill with clean water mixed with a suitable quantity of approved windscreen washer fluid which contains antifreeze.

### Caution

Only washer fluid with a sufficient antifreeze concentration provides protection at low temperatures or a sudden drop in temperature.

Washer fluid ↻ 235.

## Brakes

In the event of minimum thickness of the brake lining, a squealing noise sounds during braking.

Continued driving is possible but have the brake lining replaced as soon as possible.

Once new brake linings are installed, do not brake unnecessarily hard for the first few journeys.

## Brake fluid

### ⚠ Warning

Brake fluid is poisonous and corrosive. Avoid contact with eyes, skin, fabrics and painted surfaces.

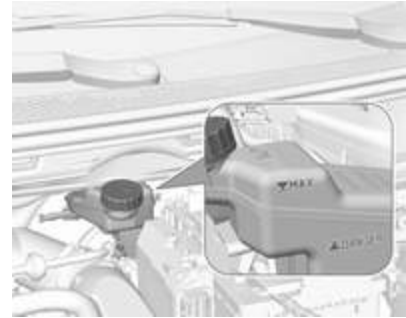

The brake fluid level must be between the **DANGER** and **MAX** marks.

If fluid level is below **DANGER** seek the assistance of a workshop.

Brake and clutch fluid ↻ 235.

## Vehicle battery

The vehicle battery is maintenance-free provided that the driving profile allows sufficient charging of the battery. Short-distance-driving and frequent engine starts can discharge the battery. Avoid the use of unnecessary electrical consumers.



Batteries do not belong in household waste. They must be disposed of at an appropriate recycling collection point.

Laying up the vehicle for more than four weeks can lead to battery discharge. Disconnect the clamp from the negative terminal of the vehicle battery.

Ensure the ignition is switched off before connecting or disconnecting the vehicle battery.

Battery discharge protection ⇨ 122.

## Replacing the vehicle battery

### Notice

Any deviation from the instructions given in this section may lead to temporary deactivation or disturbance of the stop-start system.

When the vehicle battery is being replaced, please ensure that there are no open ventilation holes in the vicinity of the positive terminal. If a ventilation hole is open in this area, it must be closed off with a dummy cap, and the ventilation in the vicinity of the negative terminal must be opened.

Ensure that the battery is always replaced by the same type of battery.

The vehicle battery has to be replaced by a workshop.

Stop-start system ⇨ 139.

## Charging the vehicle battery

### ⚠ Warning

On vehicles with stop-start system, ensure that the charging potential does not exceed 14.6 volts when using a battery charger. Otherwise the vehicle battery might be damaged.

Jump starting ⇨ 228.

## Warning label



Meaning of symbols:

- No sparks, naked flames or smoking.
- Always shield eyes. Explosive gases can cause blindness or injury.
- The vehicle battery contains sulphuric acid which could cause blindness or serious burn injuries.
- Keep the vehicle battery out of reach of children.

- See the Owner's Manual for further information.
- Explosive gas may be present in the vicinity of the vehicle battery.

## Diesel fuel system bleeding

If the tank has been run dry, the diesel fuel system must be bled. Switch on the ignition three times for 15 seconds at a time. Then crank the engine for a maximum of 40 seconds. Repeat this process after no less than five seconds. If the engine fails to start, seek the assistance of a workshop.

## Wiper blade replacement



Lift the wiper arm until it stays in the raised position, press button to disengage the wiper blade and remove.

Attach the wiper blade slightly angled to the wiper arm and push until it engages.

Lower wiper arm carefully.

## Wiper blade on the rear window



Lift wiper arm. Disengage wiper blade as shown in illustration and remove.

Attach the wiper blade slightly angled to the wiper arm and push until it engages.

Lower wiper arm carefully.

## Bulb replacement

Switch off the ignition and switch off the relevant switch or close the doors. Only hold a new bulb at the base. Do not touch the bulb glass with bare hands.

Use only the same bulb type for replacement.

Replace headlight bulbs from within the engine compartment.

### Bulb check

After a bulb replacement switch on the ignition, operate and check the lights.

### Halogen headlights

Halogen headlights with separate bulbs for low beam and high beam.

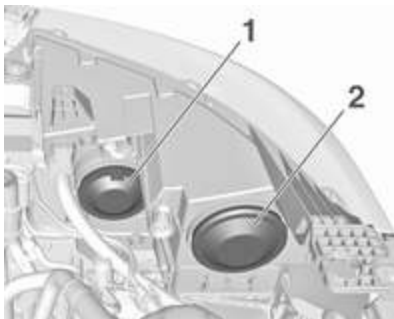

High beam (1) inner bulb.

Low beam (2) outer bulb.

### High beam (1)



1. Remove the protective cover by pulling the tab.



2. Press retaining clip downwards and pull the bulb socket toward the rear.

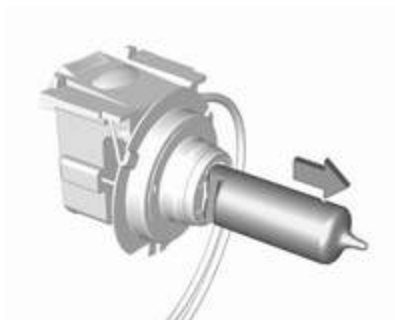

3. Detach the bulb from the bulb socket and replace the bulb.
4. Insert the bulb socket into the reflector housing.
5. Fit the cap on.

### Low beam (2)



1. Remove the protective cover by pulling.



2. Press retaining clip upwards and pull the bulb socket toward the rear.

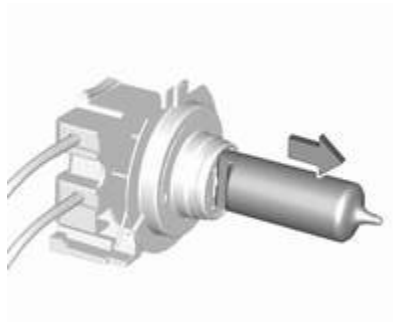

3. Detach the bulb from the bulb socket and replace the bulb.

4. Insert the bulb socket into the reflector housing.
5. Fit the cap on.

### Front turn signal light

In case of defective LEDs, have them replaced by a workshop.

### Side light

In case of defective LEDs, have them replaced by a workshop.

### Daytime running light

In case of defective LEDs, have them replaced by a workshop.

### LED headlights

Headlights for low and high beam, sidelights, daytime running lights and turn signal lights are designed as LEDs and can not be changed.

Have lights repaired by a workshop in case of failure.

### Fog lights

Have bulbs replaced by a workshop.

## Tail lights

Tail lights, daytime running lights and centre high-mounted brake light are designed as LEDs. In case of failure, have LEDs replaced by a workshop.

### Light assembly in the body



1. Open the tailgate then unclip the access cover on the relevant side.



2. Slacken the lamp fixing nut using a box spanner or socket.  
To avoid losing the nut if it drops into the wing trim, first place a cloth below it.
3. Manually unscrew and remove the lamp fixing nut.
4. Disengage the retaining clip, while pushing the lamp out slightly.

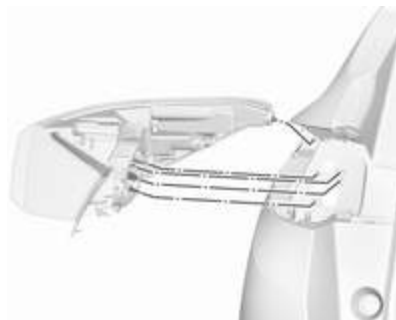

5. From the outside, carefully withdraw the light assembly from recess and remove. Take care that the cable duct remains in position.
6. Turn the bulb socket anticlockwise and remove it from the light assembly.

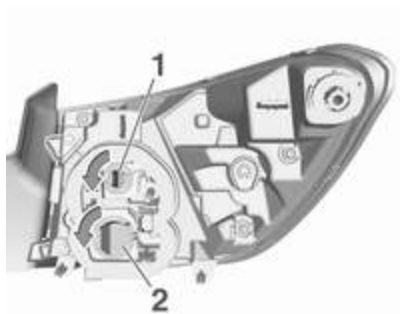

7. Detach the bulb from the bulb socket and replace the bulb:

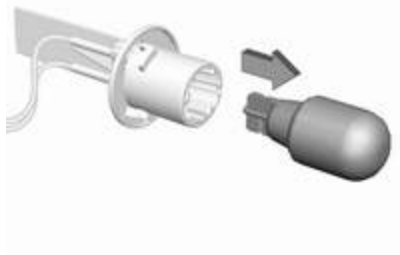

Brake light(1)

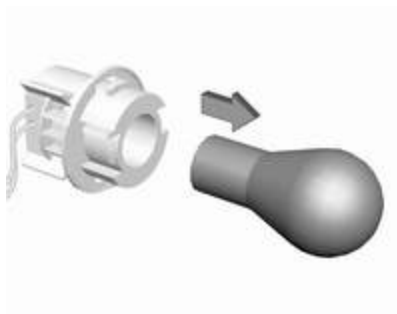

- Turn signal light (2)
8. Insert the bulb socket into the light assembly. Fit the light assembly in the recess and tighten the lamp fixing nut from the inside. Attach the cover.

### Light assembly in the tailgate



1. Open the tailgate and remove the cover.

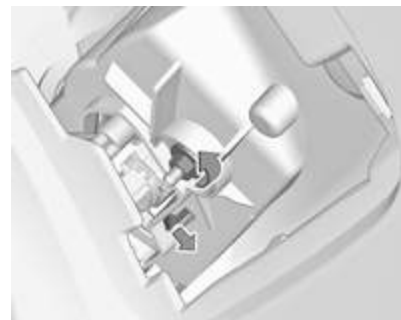

2. Slacken the lamp fixing nut using a box spanner or socket.
3. Manually unscrew and remove the lamp fixing nut.
4. Disengage the retaining clip, while pushing the light assembly out slightly.
5. From the outside, carefully withdraw light assembly from recess and remove. Take care that the cable duct remains in position.

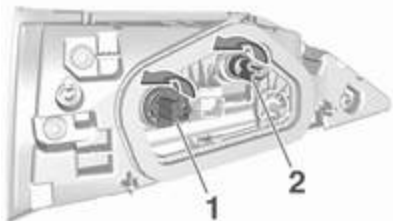

6. Turn the bulb socket anticlockwise and remove it from the light assembly.

7. Detach the bulb from the bulb socket and replace the bulb:



Reverse light (1)

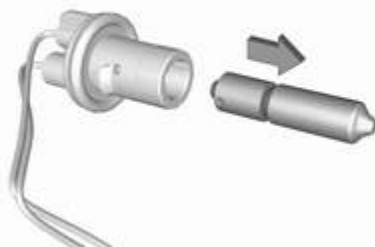

Rear fog light (2)

8. Insert the bulb socket into the light assembly. Fit the light assembly in the recess and tighten the lamp fixing nut from the inside. Attach the cover.

### Centre high-mounted brake light

The centre high-mounted brake light is designed as LED and can not be changed.

Have lights repaired by a workshop in case of failure.

### Bulb check

Switch on the ignition, operate and check all lights.



## Side turn signal lights

To replace bulb, remove lamp housing:



1. Slide lamp to its left side and remove with its right end.



2. Turn bulb socket clockwise and remove from housing.

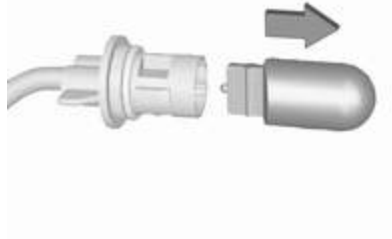

3. Detach the bulb from the bulb socket and replace the bulb.

4. Insert bulb socket and turn anticlockwise.
5. Insert left end of the lamp, slide to the left and insert right end.

## Number plate light

Number plate lights are designed as LEDs and can not be changed.

Have lights repaired by a workshop in case of failure.

## Interior lights

### Courtesy lights, reading lights

Have bulbs replaced by a workshop.

### Load compartment light

Have bulbs replaced by a workshop.

### Instrument panel illumination

Have bulbs replaced by a workshop.

## Vehicle tools

### Tools

#### Vehicles with spare wheel

Open the floor cover of the load compartment ↗ 72.

Remove the cover of the tool box.



The jack, the towing eye, chocks and the tools are located in the tool box.

#### Vehicles without spare wheel



The towing eye and the chocks are located in a box below the floor cover in the load compartment.

Tyre repair kit ↗ 221.

#### Vehicles with audio speaker system



The towing eye and the chocks are located in a box below the floor cover in the load compartment.

Tyre repair kit ↗ 221.

## Wheels and tyres

### Tyre condition, wheel condition

Drive over edges slowly and at right angles if possible. Driving over sharp edges can cause tyre and wheel damage. Do not trap tyres on the kerb when parking.

Regularly check the wheels for damage. Seek the assistance of a workshop in the event of damage or unusual wear.

### Winter tyres

Winter tyres improve driving safety at temperatures below 7 °C and should therefore be fitted on all wheels.

In accordance with country-specific regulations, affix the speed sticker in the driver's field of view.

All tyre sizes are permitted as winter tyres ⇨ 247.

### Tyre designations

E.g. **225/55 R 18 98 V**

- 225** : tyre width, mm
- 55** : cross-section ratio (tyre height to tyre width), %
- R** : belt type: Radial
- RF** : type: RunFlat
- 18** : wheel diameter, inches
- 98** : load index e.g. 98 is equivalent to 750 kg
- V** : speed code letter

Speed code letter:

- Q** : up to 100 mph
- S** : up to 112 mph
- T** : up to 118 mph
- H** : up to 130 mph
- V** : up to 150 mph
- W** : up to 168 mph

Choose a tyre appropriate for the maximum speed of your vehicle.

The maximum speed is achievable at kerb weight with driver (75 kg) plus 125 kg payload. Optional equipment could reduce the maximum speed of the vehicle.

Performance ⇨ 244.

### Directional tyres

Directional tyres should be mounted so that they rotate in the correct direction. The proper rotation direction is indicated by a symbol (e.g. an arrow) on the sidewall.

### Tyre pressure

Check the pressure of cold tyres at least every 14 days and before any long journey. Do not forget the spare wheel. This also applies to vehicles with tyre pressure monitoring system.



Tyre pressure ⇨ 247.

The tyre pressure information label on the left door frame indicates the original equipment tyres and the correspondent tyre pressures.

The tyre pressure data refers to cold tyres. It applies to summer and winter tyres.

Always inflate the spare tyre to the pressure specified for full load.

The ECO tyre pressure serves to achieve the smallest amount of fuel consumption possible.

Incorrect tyre pressures will impair safety, vehicle handling, comfort and fuel economy and will increase tyre wear.

Tyre pressures differ depending on various options. For the correct tyre pressure value, follow the procedure below:

1. Identify the engine identifier code.  
Engine data ↗ 243.
2. Identify the respective tyre.

The tyre pressure tables show all possible tyre combinations ↗ 247.

For the tyres approved for your vehicle, refer to the EEC Certificate of Conformity provided with your vehicle or other national registration documents.

The driver is responsible for correct adjustment of tyre pressure.

### Warning

If the pressure is too low, this can result in considerable tyre warm-up and internal damage, leading to tread separation and even to tyre blow-out at high speeds.

### Warning

For specific tyres the recommended tyre pressure as shown in the tyre pressure table may exceed the maximum tyre pressure as indicated on the tyre. Never exceed the maximum tyre pressure as indicated on the tyre.

## Temperature dependency

The tyre pressure depends on the temperature of the tyre. During driving, tyre temperature and pressure increase. Tyre pressure values provided on the tyre information label and tyre pressure chart are valid for cold tyres, which means at 20 °C.

The pressure increases by nearly 1.5 psi for a 10 °C temperature increase. This must be considered when warm tyres are checked.

The tyre pressure value displayed in the Driver Information Centre shows the real tyre pressure. A cooled down tyre will show a decreased value, which does not indicate an air leak.

## Tyre deflation detection system

The tyre deflation detection system continually checks the rotation speed of all four wheels and warns on low tyre pressure condition once vehicle is driving. This is achieved by comparing tyre rolling circumference with reference values.

If a tyre loses pressure the control indicator (⚠) illuminates and a warning message is displayed in the Driver Information Centre.

In this case reduce speed, avoid sharp cornering and strong braking. Stop at next safe opportunity and check tyre pressure.

Control indicator (⚠) ⇨ 97.

After adjusting tyre pressure initialise system to extinguish the control indicator and restart system.

### Caution

Deflation detection system warns just about low tyre pressure condition and does not replace regular tyre maintenance by the driver.

In case of a system malfunction a message is displayed in the Driver Information Centre. Set correct tyre pressure and reinitialise system. If the failure continues to be displayed, contact a workshop. The system is inoperable when ABS or ESC has a malfunction or a temporary spare

wheel is used. Once the road tyre has been refitted, check the tyre pressure with cold tyres and initialise the system.

### System initialisation



After tyre pressure correction or wheel change, the system must be initialised to learn new circumference reference values:

1. Always ensure that all four tyres have correct tyre pressure ⇨ 247.
2. Apply manual parking brake.

3. Press (⚠) to reset deflation detection system.
4. Reset is confirmed by pop-up indication.

After initialisation system automatically calibrates to new tyre pressures during driving. After longer drive the system will adopt and monitor new pressures.

Always check tyre pressure with cold tyres.

System has to be reinitialised when:

- Tyre pressure has been changed
- Load condition has been changed
- Wheels have been swapped or exchanged

The system will not warn instantaneously on a tyre blow out or a rapid deflation. This is due to required calculation time.

### Tread depth

Check tread depth at regular intervals.

Tyres should be replaced for safety reasons at a tread depth of 2-3 mm (4 mm for winter tyres).

For safety reasons, it is recommended that the tread depth of the tyres on one axle should not vary by more than 2 mm.



The legally permissible minimum tread depth (1.6 mm) has been reached when the tread has worn down as far as one of the tread wear indicators (TWI). Their position is indicated by markings on the sidewall.

If there is more wear at the front than the rear, swap round front wheels and rear wheels periodically. Ensure that the direction of rotation of the wheels remains the same.

Tyres age, even if they are not used. We recommend tyre replacement every 6 years.

### Changing tyre and wheel size

If tyres of a different size than those fitted at the factory are used, it may be necessary to reprogramme the speedometer as well as the nominal tyre pressure and make other vehicle modifications.

After converting to a different tyre size, have the label with tyre pressures replaced and the tyre deflation detection system reinitialised. ⇨ 218

### **⚠ Warning**

The use of unsuitable tyres or wheels may lead to accidents and will invalidate the vehicle operating permit.

### Wheel covers

Wheel covers and tyres that are factory approved for the respective vehicle and comply with all of the relevant wheel and tyre combination requirements must be used.

If the wheel covers and tyres used are not factory approved, the tyres must not have a rim protection ridge.

Wheel covers must not impair brake cooling.

**⚠ Warning**

Use of unsuitable tyres or wheel covers could lead to sudden pressure loss and thereby accidents.

Vehicles with steel wheels: When using locking wheel nuts, do not attach wheel covers.

**Tyre chains**

Tyre chains are only permitted on the front wheels.

Always use fine mesh chains that add no more than 9 mm to the tyre tread and the inboard sides (including chain lock).

**⚠ Warning**

Damage may lead to tyre blowout.

Tyre chains are permitted on tyres of size 215/70R16, 215/65 R17, 225/55 R18 and 205/55 R19.

**Temporary spare wheel**

The use of tyre chains is not permitted on the temporary spare wheel.

**Tyre repair kit**

Minor damage to the tyre tread can be repaired with the tyre repair kit.

Do not remove foreign bodies from the tyres.

Tyre damage exceeding 4 mm or that is at tyre's sidewall cannot be repaired with the tyre repair kit.

**⚠ Warning**

Do not drive faster than 50 mph.  
Do not use for a lengthy period.  
Steering and handling may be affected.

If you have a flat tyre:

Apply the parking brake and engage first gear, reverse gear or **P**.



The tyre repair kit is in the load compartment below the floor cover.

1. Remove the sealant bottle and the compressor.

2. Pull speed limit label from sealant bottle and place it in driver's visible area.



3. Remove the electrical connection cable and air hose from the stowage compartments on the underside of the compressor.



4. Screw the compressor air hose to the connection on the sealant bottle.

5. Fit the sealant bottle into the bracket on the compressor.

Set the compressor near the tyre in such a way that the sealant bottle is upright.

6. Unscrew valve cap from defective tyre.

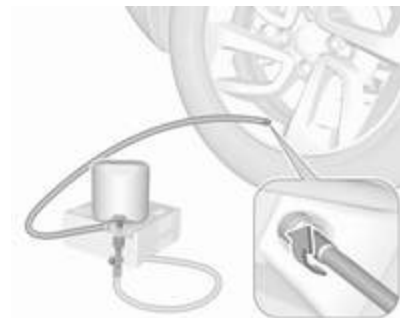

7. Screw the filler hose to the tyre valve.

8. The switch on the compressor must be set to O.

9. Connect the compressor plug to the power outlet or cigarette lighter socket.

To avoid discharging the battery, we recommend running the engine.



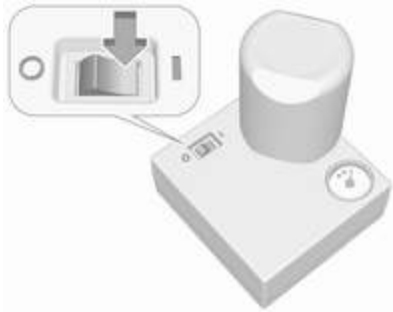

10. Set the rocker switch on the compressor to I. The tyre is filled with sealant.
11. The compressor pressure gauge briefly indicates up to 6 bar whilst the sealant bottle is emptying (approx. 30 seconds). Then the pressure starts to drop.
12. All of the sealant is pumped into the tyre. Then the tyre is being inflated.
13. The prescribed tyre pressure should be obtained within ten minutes.

Tyre pressure ⇨ 247.

When the correct pressure is obtained, switch off the compressor.

If the prescribed tyre pressure is not obtained within ten minutes, remove the tyre repair kit. Move the vehicle one tyre rotation.

Reattach the tyre repair kit and continue the filling procedure for ten minutes. If the prescribed tyre pressure is still not obtained, the tyre is too badly damaged. Seek the assistance of a workshop.

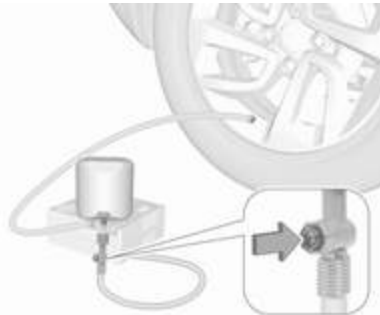

Drain excess tyre pressure with the button on the air hose.

Do not run the compressor longer than ten minutes.

14. Detach the tyre repair kit. Remove sealant bottle from bracket. Screw the filler hose to the free connection of the sealant bottle. This prevents sealant from escaping. Stow tyre repair kit in load compartment.
15. Remove any excess sealant using a cloth.



16. Continue driving immediately so that sealant is evenly distributed in the tyre. After driving approx. three miles (but no more than ten minutes), stop and check tyre pressure. Screw compressor air hose directly onto tyre valve when doing this. Fill tyre as described

before. Drain excess tyre pressure with the button on the air hose.

If tyre pressure hasn't decreased under 1.5 bar, set it to the correct value. Otherwise the vehicle must not be used. Seek assistance of a workshop. ⇨ 247

Repeat the checking procedure once more after driving further three miles (but no more than ten minutes) to check that there is no more loss of pressure.

If the tyre pressure has fallen below 1.5 bar, the vehicle must not be used. Seek the assistance of a workshop.

17. Stow away tyre repair kit in load compartment.

#### Notice

The driving characteristics of the repaired tyre are severely affected, therefore have this tyre replaced.

If unusual noise is heard or the compressor becomes hot, turn compressor off for at least 30 minutes.

The built-in safety valve opens at a pressure of seven bar (102 psi).

Note the expiry date of the kit. After this date its sealing capability is no longer guaranteed. Pay attention to storage information on sealant bottle.

Replace the used sealant bottle. Dispose of the bottle as prescribed by applicable laws.

The compressor and sealant can be used from approx. -30 °C.

## Wheel changing

Some vehicles are equipped with a tyre repair kit instead of a spare wheel ⇨ 221.

Make the following preparations and observe the following information:

- Park the vehicle on a level, firm and non-skid surface. The front wheels must be in the straight-ahead position.
- If necessary, place a chock under the wheel diagonally opposite the wheel to be changed.

- Apply the parking brake and engage first gear, reverse gear or P.
- Remove the spare wheel ⇨ 227.
- Never change more than one wheel at once.
- Use the jack only to change wheels in case of puncture, not for seasonal winter or summer tyre change.
- The jack is maintenance-free.
- If the ground on which the vehicle is standing is soft, a solid board (max. 1 cm thick) should be placed under the jack.
- Take heavy objects out of the vehicle before jacking up.
- No people or animals may be in the vehicle when it is jacked-up.
- Never crawl under a jacked-up vehicle.
- Do not start the vehicle when it is raised on the jack.
- Before screwing in the wheel bolts, clean them.

### ⚠ Warning

Do not grease the thread of the wheel bolt.

1. Disengage wheel bolt caps with the wheel bolt cover remover.  
↪ 216

Steel wheels with cover: Pull off the wheel cover.

Alloy wheels: Disengage wheel bolt caps with the wheel bolt cover remover.



2. Fold out the wheel wrench and install ensuring that it locates

securely and loosen each wheel nut by half a turn.

The wheels might be protected by locking wheel nuts. To loosen these specific nuts first attach the adapter onto the head of the nut before installing the wheel wrench. The adapter is located in the tool box. ↪ 216



3. Ensure the jack is correctly positioned under the relevant vehicle jacking point.



4. Set the jack to the necessary height. Position it directly below the jacking point in a manner that prevents it from slipping.

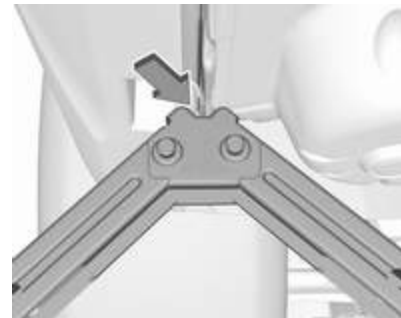

Ensure that the edge of the body fits into the notch of the jack.



Attach wheel wrench and with the jack correctly aligned rotate wheel wrench until wheel is clear of the ground.

5. Unscrew the wheel nuts.
6. Change the wheel. Spare wheel  $\varnothing$  227
7. Screw on the wheel nuts.
8. Lower the vehicle and remove jack.

9. Install the wheel wrench ensuring that it is located securely and tighten each bolt in a crosswise sequence. Tightening torque is 115 Nm.
10. Align the valve hole in the wheel cover with the tyre valve before installing.

Install wheel nut caps.

11. Stow the replaced wheel  $\varnothing$  227, the vehicle tools  $\varnothing$  216 and the adapter for the locking wheel nuts.
12. Check the tyre pressure of the installed tyre and the wheel nut torque as soon as possible.

Have the defective tyre renewed or repaired as soon as possible.

### Jacking position for lifting platform



Rear arm position of the lifting platform centrally under the relevant vehicle jacking point.



Front arm position of the lifting platform centrally under the relevant vehicle jacking point.

## Spare wheel

Some vehicles are equipped with a tyre repair kit instead of a temporary spare wheel. ⇨ 221

## Temporary spare wheel

### Caution

The use of the temporary spare wheel could affect driveability. Have the defective tyre renewed or repaired as soon as possible.



The spare wheel is located in the load compartment beneath the floor covering.

To remove:

1. Open the floor cover ⇨ 72.
2. Remove the tool box.
3. The temporary spare wheel is secured with a wing nut. Unscrew nut and take out the spare wheel.

4. When, after a wheel change, no wheel is placed in the spare wheel well, secure the tool box by tightening the wing nut as far as it will go and close floor cover.
5. After wheel change back to full size wheel, place the temporary spare wheel outside up in the well and secure with the wing nut.

Only mount one temporary spare wheel. The permissible maximum speed on the label on the temporary spare wheel is only valid for the factory-fitted tyre size.

If your vehicle gets a flat tyre on the rear while towing another vehicle, mount the temporary spare wheel in the front and the full size tyre in the rear.

Tyre chains ⇨ 221.

## Stowing a damaged full size wheel in the load compartment

All permitted wheel sizes can be stowed in the spare wheel well. To secure the wheel:



1. Remove centre cap with the brand emblem by pushing from the inside.
2. Position the wheel outside down in the wheel well.
3. Secure the defective wheel with the wing nut.
4. Depending on the tyre size, the floor cover can be placed on the projecting wheel.

## Jump starting

Do not start with quick charger.

A vehicle with a discharged vehicle battery can be started using jump leads and the vehicle battery of another vehicle.

### ⚠ Warning

Be extremely careful when starting with jump leads. Any deviation from the following instructions can lead to injuries or damage caused by battery explosion or damage to the electrical systems of both vehicles.

### ⚠ Warning

Avoid contact of the battery with eyes, skin, fabrics and painted surfaces. The fluid contains sulphuric acid which can cause injuries and damage in the event of direct contact.

- Never expose the vehicle battery to naked flames or sparks.

- A discharged vehicle battery can already freeze at a temperature of 0 °C. Defrost the frozen battery before connecting jump leads.
- Wear eye protection and protective clothing when handling a battery.
- Use a booster battery with the same voltage (12 Volts). Its capacity (Ah) must not be much less than that of the discharged vehicle battery.
- Use jump leads with insulated terminals and a cross section of at least 16 mm<sup>2</sup> (25 mm<sup>2</sup> for diesel engines).
- Do not disconnect the discharged vehicle battery from the vehicle.
- Switch off all unnecessary electrical consumers.
- Do not lean over the vehicle battery during jump starting.
- Do not allow the terminals of one lead to touch those of the other lead.

- The vehicles must not come into contact with each other during the jump starting process.
- Apply the parking brake, transmission in neutral, automatic transmission in **P**.

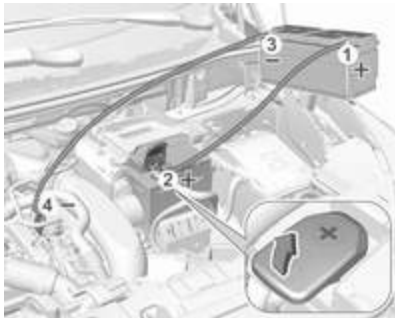

Open the positive terminal protection caps of both vehicle batteries.

Lead connection order:

1. Connect the red lead to the positive terminal of the booster battery.
  2. Connect the other end of the red lead to the positive terminal of the discharged battery.
  3. Connect the black lead to the negative terminal of the booster battery.
  4. Connect the other end of the black lead to a vehicle grounding point of your vehicle in the engine compartment.
- Route the leads so that they cannot catch on rotating parts in the engine compartment.
- To start the engine:
1. Start the engine of the vehicle providing the jump.
  2. After five minutes, start the other engine. Start attempts should be made for no longer than 15 seconds at an interval of one minute.
  3. Allow both engines to idle for approx. three minutes with the leads connected.
  4. Switch on electrical consumers (e.g. headlights, heated rear window) of the vehicle receiving the jump start.
  5. Reverse above sequence exactly when removing leads.

## Towing

### Towing the vehicle



Remove the cap.

The towing eye is stowed with the vehicle tools ⇨ 216.

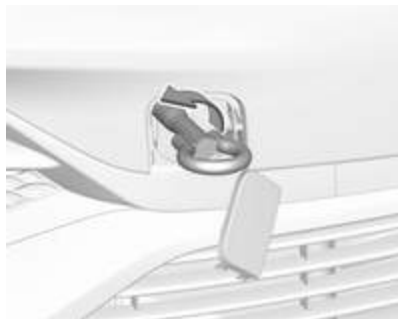

Screw in the towing eye as far as it will go until it stops in a horizontal position.

Attach a tow rope – or better still a tow rod – to the towing eye.

The towing eye must only be used for towing and not for recovering the vehicle.

Switch on ignition to release steering wheel lock and to permit operation of brake lights, horn and windscreen wiper.

Switch the selector lever to neutral.

Release the parking brake.

### Caution

Drive slowly. Do not drive jerkily. Excessive tractive force can damage the vehicle.

When the engine is not running, considerably more force is needed to brake and steer.

To prevent the entry of exhaust gases from the towing vehicle, switch on the air recirculation and close the windows.

Vehicles with automatic transmission: The vehicle must be towed facing forwards, not faster than 50 mph nor further than 60 miles. In all other cases and when the transmission is defective, the front axle must be raised off the ground.

Seek the assistance of a workshop.

After towing, unscrew the towing eye.

Insert cap with the flange into the recess and fix cap by pushing.

### Towing another vehicle



Remove the cap.

The towing eye is stowed with the vehicle tools ⇨ 216.

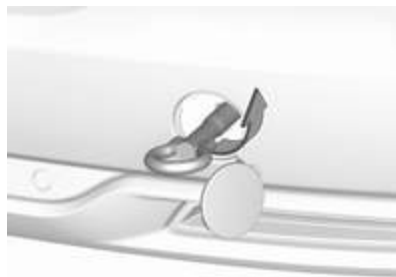



Screw in the towing eye as far as it will go until it stops in a horizontal position.

The lashing eye at the rear underneath the vehicle must never be used as a towing eye.

Attach a tow rope – or better still a tow rod – to the towing eye.

The towing eye must only be used for towing and not for recovering a vehicle.

### Caution

Drive slowly. Do not drive jerkily. Excessive tractive force can damage the vehicle.

After towing, unscrew the towing eye.

Insert cap with the upper flange into the recess and fix cap by pushing.

## Appearance care

### Exterior care

#### Locks

The locks are lubricated at the factory using a high quality lock cylinder grease. Use a de-icing agent only when absolutely necessary, as this has a degreasing effect and impairs lock function. After using a de-icing agent, have the locks regreased by a workshop.

#### Washing

The paintwork of your vehicle is exposed to environmental influences. Wash and wax your vehicle regularly. When using automatic vehicle washes, select a programme that includes waxing.

Bird droppings, dead insects, resin, pollen and the like should be cleaned off immediately, as they contain aggressive constituents which can cause paint damage.

If using a vehicle wash, comply with the vehicle wash manufacturer's instructions. The windscreen wiper and rear window wiper must be switched off. Remove antenna and external accessories such as roof racks etc.

If you wash your vehicle by hand, make sure that the insides of the wheel housings are also thoroughly rinsed out.

Wax painted parts of the vehicle regularly.

Clean edges and folds on opened doors and the bonnet as well as the areas they cover.

Clean bright metal mouldings with a cleaning solution approved for aluminium to avoid damages.

### Caution

Always use a cleaning agent with a pH value of four to nine.

Do not use cleaning agents on hot surfaces.

Do not clean the engine compartment with a steam-jet or high-pressure jet cleaner.

Thoroughly rinse and leather-off the vehicle. Rinse leather frequently. Use separate leathers for painted and glass surfaces: remnants of wax on the windows will impair vision.

Have the door hinges of all doors greased by a workshop.

### **Exterior lights**

Headlight and other light covers are made of plastic. Do not use any abrasive or caustic agents, do not use an ice scraper, and do not clean them dry.

### **Polishing and waxing**

Wax the vehicle regularly (at the latest when water no longer beads). Otherwise, the paintwork will dry out.

Polishing is necessary only if the paint has become dull or if solid deposits have become attached to it.

Paintwork polish with silicone forms a protective film, making waxing unnecessary.

Plastic body parts must not be treated with wax or polishing agents.

### **Windows and windscreen wiper blades**

Use a soft lint-free cloth or chamois leather together with window cleaner and insect remover.

When cleaning the rear window from inside, always wipe in parallel to the heating element to prevent damage.

For mechanical removal of ice, use a sharp-edged ice scraper. Press the scraper firmly against the glass so that no dirt can get under it and scratch the glass.

Clean smearing wiper blades with a soft cloth and window cleaner.

Remove dirt residues from smearing wiper blades by using a soft cloth and window cleaner. Also make sure to remove any residues such as wax, insect residues and similar from the window.

Ice residues, pollution and continuous wiping on dry windows will damage or even destroy the wiper blades.

### **Glass panel**

Never clean with solvents or abrasive agents, fuels, aggressive media (e.g. paint cleaner, acetone-containing solutions etc.), acidic or highly alkaline media or abrasive pads.

### **Wheels and tyres**

Do not use high-pressure jet cleaners.

Clean rims with a pH-neutral wheel cleaner.

Rims are painted and can be treated with the same agents as the body.

### **Paintwork damage**

Rectify minor paintwork damage with a touch-up pen before rust forms. Have more extensive damage or rust areas repaired by a workshop.

### **Underbody**

Some areas of the vehicle underbody have a PVC undercoating while other critical areas have a durable protective wax coating.

After the underbody is washed, check the underbody and have it waxed if necessary.

Bitumen/rubber materials could damage the PVC coating. Have underbody work carried out by a workshop.

Before and after winter, wash the underbody and have the protective wax coating checked.

### Liquid gas system

**⚠ Danger**

Liquid gas is heavier than air and can collect in sink points.

Take care when performing work at the underbody in a pit.

For painting work and when using a drying booth at a temperature above 60 °C, the liquid gas tank must be removed.

Do not make any modifications to the liquid gas system.

### Towing equipment

Do not clean the coupling ball bar with a steam-jet or high-pressure jet cleaner.

### Interior care

#### Interior and upholstery

Only clean the vehicle interior, including the instrument panel fascia and panelling, with a dry cloth or interior cleaner.

Clean the leather upholstery with clear water and a soft cloth. In case of heavy soiling, use leather care.

The instrument cluster and the displays should only be cleaned using a soft damp cloth. If necessary use a weak soap solution.

Clean fabric upholstery with a vacuum cleaner and brush. Remove stains with an upholstery cleaner.

Clothing fabrics may not be colourfast. This could cause visible discolourations, especially on light-

coloured upholstery. Removable stains and discolourations should be cleaned as soon as possible.

Clean seat belts with lukewarm water or interior cleaner.

**Caution**

Close Velcro fasteners as open Velcro fasteners on clothing could damage seat upholstery.

The same applies to clothing with sharp-edged objects, like zips or belts or studded jeans.

### Plastic and rubber parts

Plastic and rubber parts can be cleaned with the same cleaner as used to clean the body. Use interior cleaner if necessary. Do not use any other agent. Avoid solvents and petrol in particular. Do not use high-pressure jet cleaners.

## Service and maintenance

<b>General information</b> .....	<b>234</b>
Service information .....	234
<b>Recommended fluids, lubricants and parts</b> .....	<b>235</b>
Recommended fluids and lubricants .....	235

## General information

### Service information

In order to ensure economical and safe vehicle operation and to maintain the value of your vehicle, it is of vital importance that all maintenance work is carried out at the proper intervals as specified.

The detailed, up-to-date service schedule for your vehicle is available at the workshop.

Severe operating conditions exist if one or more of the following circumstances occur frequently: Cold starting, stop and go operation, e.g. for taxis and police vehicles, trailer operation, mountain driving, driving on poor and sandy road surfaces, increased air pollution, presence of airborne sand and high dust content, driving at high altitude and large variations of temperature.

Under these severe operating conditions, certain service work may be required more frequently than the regular service interval indicated in

the service display. Contact a workshop for customised service schedules.

Service display ⇨ 91.

### Service intervals - country group 1

Maintenance of your vehicle is required every 16,000 miles or after one year, whichever occurs first, unless otherwise indicated in the service display.

These service intervals are valid for the following countries:

Andorra, Austria, Belgium, Cyprus, Denmark, Finland, France, Germany, Greece, Iceland, Ireland, Italy, Liechtenstein, Luxembourg, Malta, Monaco, Netherlands, Norway, Portugal, San Marino, Spain, Sweden, Switzerland, United Kingdom.

### Service intervals - country group 2

Maintenance of your vehicle is required every 10,000 miles or after one year, whichever occurs first, unless otherwise indicated in the service display.

These service intervals are valid for the following countries:

Albania, Estonia, Latvia, Lithuania, Macedonia, Montenegro, Poland, Serbia, Slovenia.

### Service intervals - country group 3

Maintenance of your vehicle equipped with engine EB2DTS is required every 6,000 miles or after one year, whichever occurs first, unless otherwise indicated in the service display. Maintenance of your vehicle with any other engine than mentioned before is required every 16,000 miles or after one year, whichever occurs first, unless otherwise indicated in the service display.

These service intervals are valid for the following countries:

Bosnia-Herzegovina, Bulgaria, Croatia, Czech Republic, Hungary, Romania, Slovakia.

### Service intervals - country group 4

Maintenance of your vehicle is required every 6,000 miles or after one year, whichever occurs first, unless otherwise indicated in the service display.

These service intervals are valid for the countries which are not listed in country group 1, 2 or 3.

### Confirmations

Confirmation of service is recorded in the Service and warranty booklet. The date and mileage is completed with the stamp and signature of the servicing workshop.

Make sure that the Service and warranty booklet is completed correctly as continuous proof of service is essential if any warranty or goodwill claims are to be met, and is also a benefit when selling the vehicle.

## Recommended fluids, lubricants and parts

### Recommended fluids and lubricants

Only use products that meet the recommended specifications.

#### Warning

Operating materials are hazardous and could be poisonous. Handle with care. Pay attention to information given on the containers.

### Engine oil

Engine oil is identified by its quality and its viscosity. Quality is more important than viscosity when selecting which engine oil to use. The oil quality ensures e.g. engine cleanliness, wear protection and oil aging control, whereas viscosity grade gives information on the oil's thickness over a temperature range.

Dexos is the newest engine oil quality that provides optimum protection for petrol and diesel engines. If it is unavailable, engine oils of other listed qualities must be used.

Recommendations for petrol engines are also valid for Compressed Natural Gas (CNG), Liquefied Petroleum Gas (LPG) and Ethanol (E85) fuelled engines.

Select the appropriate engine oil based on its quality and on the minimum ambient temperature ⇨ 240.

### Topping up engine oil

<b>Caution</b>
----------------

In case of any spilled oil, wipe it up and dispose it properly.
---

Engine oils of different manufacturers and brands can be mixed as long as they comply with the required engine oil quality and viscosity.

Use of engine oils for all petrol engines with only ACEA quality is prohibited, since it can cause engine damage under certain operating conditions.

Select the appropriate engine oil based on its quality and on the minimum ambient temperature ⇨ 240.

### Additional engine oil additives

The use of additional engine oil additives could cause damage and invalidate the warranty.

### Engine oil viscosity grades

The SAE viscosity grade gives information of the thickness of the oil.

Multigrade oil is indicated by two figures, e.g. SAE 5W-30. The first figure, followed by a W, indicates the low temperature viscosity and the second figure the high temperature viscosity.

Select the appropriate viscosity grade depending on the minimum ambient temperature ⇨ 240.

All of the recommended viscosity grades are suitable for high ambient temperatures.

### Coolant and antifreeze

Use only organic acid type-long life coolant (LLC) antifreeze approved for the vehicle. Consult a workshop.

The system is factory filled with coolant designed for excellent corrosion protection and frost protection down to approx. -28 °C. In cold regions with very low temperatures the factory filled coolant provides frost protection down to approx. -37 °C. This concentration should be maintained all year round. The use of additional coolant additives that intend to give additional corrosion protection or seal against minor leaks can cause function problems. Liability for consequences resulting from the use of additional coolant additives will be rejected.

**Washer fluid**

Use only washer fluid approved for the vehicle to prevent damage of wiper blades, paintwork, plastic and rubber parts. Consult a workshop.

**Brake and clutch fluid**

Over time, brake fluid absorbs moisture which will reduce braking effectiveness. The brake fluid should therefore be replaced at the specified interval.

**AdBlue**

Only use AdBlue to reduce the nitrogen oxides in the exhaust emission ↪ 143.

## Technical data

<b>Vehicle identification</b> .....	<b>238</b>
Vehicle Identification Number ..	238
Identification plate .....	238
Engine identification .....	239
<b>Vehicle data</b> .....	<b>240</b>
Recommended fluids and lubricants .....	240
Engine data .....	243
Performance .....	244
Vehicle weight .....	244
Vehicle dimensions .....	245
Capacities .....	245
Tyre pressures .....	247

## Vehicle identification

### Vehicle Identification Number



The Vehicle Identification Number may be embossed on the instrument panel, visible through the windscreen, or in the engine compartment on the right body panel.

## Identification plate



The identification plate is located on the front left or right door frame.

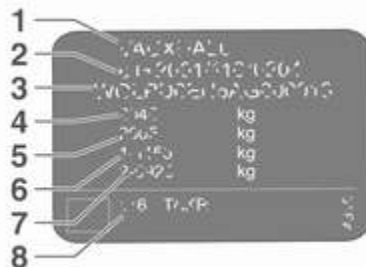



Information on identification label:

- 1 : manufacturer
- 2 : type approval number
- 3 : vehicle identification number
- 4 : permissible gross vehicle weight rating in kg
- 5 : permissible gross train weight in kg
- 6 : maximum permissible front axle load in kg
- 7 : maximum permissible rear axle load in kg
- 8 : vehicle-specific or country-specific data

The combined total of front and rear axle loads must not exceed the permissible gross vehicle weight. For example, if the front axle is bearing its maximum permissible load, the rear axle can only bear a load that is equal to the gross vehicle weight minus the front axle load.

The technical data is determined in accordance with European Community standards. We reserve the right to make modifications. Specifications in the vehicle documents always have priority over those given in this manual.

## Engine identification

The technical data tables show the engine identifier code. Engine data ⇨ 243.

To identify the respective engine, refer to the engine power in the EEC Certificate of Conformity provided with your vehicle or other national registration documents.

## Vehicle data

### Recommended fluids and lubricants

#### European service schedule

#### Required engine oil quality

All European countries with European service interval (country groups 1,2,3) ⇨ 234

Engine oil quality	Petrol engines (including CNG, LPG, E85)	Diesel engines
dexos1 Gen2	✓	–
dexos2	–	✓

Diesel engines only: In case dexos quality is unavailable, you may use max. one litre engine oil quality ACEA C3 once between each oil change.

#### Engine oil viscosity grades

All European countries with European service interval (country groups 1,2,3) ⇨ 234

Ambient temperature	Petrol and diesel engines
down to -25 °C	SAE 0W-30 or SAE 0W-40
	SAE 5W-30 or SAE 5W-40
below -25 °C	SAE 0W-30 or SAE 0W-40

**International service schedule**
**Required engine oil quality**

**All countries with international service interval (country group 4) ⇨ 234**

Engine oil quality	Petrol engines (including CNG, LPG, E85)	Diesel engines
<b>dexos1 Gen2</b>	✓	–
<b>dexos2</b>	–	✓

In case dexos quality is unavailable you may use the oil qualities listed below:

**All countries with international service interval (country group 4) ⇨ 234**

Engine oil quality	Petrol engines (including CNG, LPG, E85)	Diesel engines
ACEA A3/B4	–	✓
ACEA C3	–	✓

**Engine oil viscosity grades**

**All countries with international service interval (country group 4) ⇨ 234**

Ambient temperature	Petrol and diesel engines
down to -25 °C	SAE 0W-30 or SAE 0W-40
	SAE 5W-30 or SAE 5W-40

### All countries with international service interval (country group 4) ⇨ 234

---

below -25 °C

SAE 0W-30 or SAE 0W-40

---

down to -20 °C

SAE 10W-30<sup>1)</sup> or SAE 10W-40<sup>1)</sup>

---

1) Permitted, but usage of oils with dexos quality is recommended.

## Engine data

<b>Engine identifier code</b>	<b>B12XHT</b>	<b>B16DTH</b>
<b>Sales designation</b>	<b>1.2 Turbo</b>	<b>1.6</b>
<b>Engineering code</b>	<b>EB2DTS</b>	<b>DV6FC</b>
Piston displacement [cm <sup>3</sup> ]	1200	1560
Engine power [kW]	96	88
at rpm	5500	3500
Torque [Nm]	230	300
at rpm	1750	1750
Fuel type	Petrol	Diesel
Octane rating RON <sup>2)</sup>		–
recommended	95	–
possible	98	–
possible	91	–
Additional fuel type	–	–

2) A country specific label at the fuel filler flap can supersede the engine specific requirement.

**Performance**

<b>Engine</b>	<b>B12xHT</b>	<b>B16DTH</b>
Maximum speed [mph]		
Manual transmission	117	117
Automatic transmission	117	115

---

**Vehicle weight****Kerb weight, basic model without any optional equipment**

	<b>Engine</b>	<b>Manual transmission</b>	<b>Automatic transmission</b>
[kg]	B12xHT	1350	1370
	B16DTH	1392	1430

---

Optional equipment and accessories increase the kerb weight.

Loading information ⇨ 76.

## Vehicle dimensions

Length [mm]	4478
Width without exterior mirrors [mm]	1841
Width with two exterior mirrors folded [mm]	1970
Width with two exterior mirrors [mm]	2098
Height (without antenna) [mm]	1623
Length of load compartment floor [mm]	876
Length of load compartment with second row at foremost position and folded third row [mm]	1868,8
Load compartment width [mm]	1053
Load compartment height at tailgate [mm]	996,6
Wheelbase [mm]	2675
Turning circle diameter [m]	10,5

## Capacities

### Engine oil

Engine	B12xHT	B16DTH
including Filter [l]	3.5	3.75
between MIN and MAX [l]	1.0	1.5

## 246 Technical data

---

### Fuel tank

Petrol/diesel, refilling quantity [l]	53
---------------------------------------	----

---

### AdBlue tank

AdBlue, refilling quantity [l]	17
--------------------------------	----

---



## Tyre pressures

Engine	Tyres	Empty vehicle with driver		With full load	
		front [kPa/bar] ([psi])	rear [kPa/bar] ([psi])	front [kPa/bar] ([psi])	rear [kPa/bar] ([psi])
B12XHT	215/70 R16, 215/65 R17	210/2.1 (30)	210/2.1 (30)	230/2.3 (33)	240/2.4 (35)
	225/55 R18	210/2.1 (30)	210/2.1 (30)	240/2.4 (35)	250/2.5 (36)
	205/55 R19	250/2.5 (36)	250/2.5 (36)	270/2.7 (39)	280/2.8 (41)
	235/50 R19	230/2.3 (33)	230/2.3 (33)	250/2.5 (36)	260/2.6 (38)
B16DTH	215/70 R16, 215/65 R17	210/2.1 (30)	210/2.1 (30)	230/2.3 (33)	240/2.4 (35)
	225/55 R18	220/2.2 (32)	220/2.2 (32)	240/2.4 (35)	250/2.5 (36)
	205/55 R19	240/2.4 (35)	240/2.4 (35)	270/2.7 (39)	280/2.8 (41)
	235/50 R19	230/2.3 (33)	230/2.3 (33)	250/2.5 (36)	260/2.6 (38)
All	Temporary spare wheel 135/80 R18	420/4.2 (60)	420/4.2 (60)	420/4.2 (60)	420/4.2 (60)

## Customer information

<b>Customer information</b> .....	<b>248</b>
Declaration of conformity .....	248
REACH .....	251
Collision damage repair .....	251
Software acknowledgement ....	251
Software update .....	253
Registered trademarks .....	254
<b>Vehicle data recording and privacy</b> .....	<b>254</b>
Event data recorders .....	254
Radio Frequency Identification (RFID) .....	255

## Customer information

### Declaration of conformity

#### Radio transmission systems

This vehicle has systems that transmit and / or receive radio waves subject to Directive 1999/5/EC or 2014/53/EU. The manufacturers of the systems listed below declare conformity with Directive 1999/5/EC or 2014/53/EU. The full text of the EU declaration of conformity for each system is available at the following internet address: [www.opel.com/conformity](http://www.opel.com/conformity)

Importer is  
Opel / Vauxhall, Bahnhofspatz,  
65423 Ruesselsheim am Main,  
Germany.

#### Navi 5.0 IntelliLink

Continental

LCIE Bureau Veritas-Site de  
Fontenay aux Roses, 33 avenue du  
général Leclerc, 92260 Fontenay aux  
Roses, France

Operation frequency (MHz)	Maximum output (dBm)
---------------------------	----------------------

2400.0 - 2483.5	2.2
-----------------	-----

2400.0 - 2483.5	15
-----------------	----

#### Infotainment system R 4.0 IntelliLink LGE

LG Electronics European Shared Service Center B.V.

Krijgsman 1, 1186 DM Amstelveen,  
The Netherlands

Operation frequency (MHz)	Maximum output (dBm)
---------------------------	----------------------

2400.0 - 2483.5	4
-----------------	---

2400.0 - 2483.5	13
-----------------	----

5725.0 - 5850.0	13
-----------------	----

#### Infotainment system R 4.0

Clarion

244 rue du Pré à Varois, 54670  
Custines, France

Operation frequency:  
2400 - 2480 MHz

Maximum output: 4 dBm

**OnStar module**

LGE

LG Electronics European Shared  
Service Center B.V.

Krijgsman 1, 1186 DM Amstelveen,  
The Netherlands

Operation frequency (MHz)	Maximum output (dBm)
---------------------------	----------------------

2402 - 2480	4
-------------	---

2412 - 2462	18
-------------	----

880 - 915	33
-----------	----

1710 - 1785	24
-------------	----

1850 - 1910	24
-------------	----

1920 - 1980	24
-------------	----

2500 - 2570	23
-------------	----

**Antenna module**

Laird

Daimlerring 31, 31135 Hildesheim,  
Germany

Operation frequency: N/A

Maximum output: N/A

ASK Automotive Pvt. Ltd.

Unit 2 Plot No. 30-31, Fathepur-  
Nawada, Manesar, Gurugram,  
Haryana 122050, India

Operation frequency: N/A

Maximum output: N/A

**Radio remote control transmitter**

Hülsbeck &amp; Fürst GmbH &amp; Co. KG

Steeger Str. 17, 42551 Velbert,  
Germany

Operation frequency: 433.92 MHz

Maximum output: 10 dBm

**Radio remote control receiver**

Delphi European, Middle Eastern &  
African Regional Offices Customer  
Technology

Center Avenue de Luxembourg,  
L-4940 Bascharage, G.D. of  
Luxembourg

Operation frequency: 119 - 128.6

Maximum output: 16dB $\mu$ A/m @ 10m**Electronic key transmitter**

Valeo

43 Rue Bayen, 75017 Paris, France

Operation frequency: 433.92 MHz

Maximum output: 10 dBm

**Immobiliser**

KOSTAL of America, Inc.

350 Stephenson Hwy, Troy MI 48083,  
USA

Operation frequency: 125 kHz

Maximum output: 5 dB $\mu$ A/m at 10m**Radar unit**

ZF TRW Autocruise SAS

Secteur de la Pointe du Diable,  
Avenue du technopôle, 29280  
Plouzane, France

Operation frequency:

24.15 - 24.25 GHz

Maximum output: 20 dBm



Wir leben Autos

### Konformitätserklärung

nach EG Richtlinie 2006/42/EG

Hiermit erklären wir, dass das Produkt:

**Produktbezeichnung:** Wogenheber  
**Typ/GM-Teilenummer:** 3637376  
**Typ/PSA-Teilenummer:** 9649243380

den Bestimmungen der Richtlinie 2006/42/EG entspricht.

Angewendete technische Normen:

GMW9737 Jacking  
GM 14337 Standard Equipment Jack - Hardware Tests  
GMW15005 Standard Equipment Jack and Spare Tire, Vehicle Test  
ISO TS 16949 Qualitätsmanagementsystem

Der Unterzeichner ist Bevollmächtigter für die Zusammenstellung der technischen Unterlagen.

Rüsselsheim, 13. Dezember 2016

Andre-Alexander Kuntze  
Engineering Group Manager Tire and Wheel Systems  
Adam Opel AG

Adam Opel AG  
Rüsselsheim  
15191 4217 70,17 81 42 17 88 00  
www.opel.de

Prüfung:  
Dr. Car-Thomas Neumann (Prüfungsleiter)  
Michael Schürer, Dr. Thomas Seifert,  
Peter Thies, Barbara Wollmer, Julian Wilke

Außendienst  
Tischler 11 Gully (Prüfungsort)

Site der Gesellschaft: Rüsselsheim  
Aussendienst:  
Adressen für die Prüfung:  
Adressiert Hauptwerk, 15191 88 00  
für Informationen siehe Seite 4

**Translation of the original declaration of conformity**

Declaration of conformity according to EC Directive 2006/42/EC

We declare that the product:

Product designation: Jack

Type/GM part number: 3637376

Type/PSA part number: 9649243380  
is in compliance with the provisions of Directive 2006/42/EC.

Applied technical standards:

GMN9737 : jacking

GM 14337 : standard equipment  
jack – hardware  
tests

GMW15005 : standard equipment  
jack and spare tyre,  
vehicle test

ISO TS 16949 : quality  
management  
systems

The signatory is authorised to compile the technical documentation.

Rüsselsheim, 13th December 2016  
signed by

André-Alexander Konter

Engineering Group Manager Tyre  
and Wheel Systems

Adam Opel GmbH

D-65423 Rüsselsheim

**REACH**

Registration, Evaluation, Authorisation and Restriction of Chemicals (REACH) is a European Union regulation adopted to improve the protection of human health and the environment from the risks that can be posed by chemicals. Visit [www.opel.com](http://www.opel.com) for further information and for access to the Article 33 communication.

**Collision damage repair****Paint thickness**

Due to production techniques, the thickness of the paint can vary between 50 and 400 µm.

Therefore, different paint thickness is no indicator for a collision damage repair.

**Software acknowledgement**

Certain OnStar components include libcurl and unzip software and other third party software. Below are the notices and licenses associated with libcurl and unzip and for other third party software please see <http://www.lg.com/global/support/opensource/index>.

**libcurl**

Copyright and permission notice

Copyright (c) 1996 - 2010, Daniel Stenberg, <[daniel@haxx.se](mailto:daniel@haxx.se)>.

All rights reserved.

Permission to use, copy, modify, and distribute this software for any purpose with or without fee is hereby granted, provided that the above copyright notice and this permission notice appear in all copies.

The software is provided "as is", without warranty of any kind, express or implied, including but not limited to the warranties of merchantability, fitness for a particular purpose and noninfringement of third party rights. In no event shall the authors or copyright holders be liable for any claim, damages or other liability, whether in an action of contract, tort or otherwise, arising from, out of or in connection with the software or the use or other dealings in the software.

Except as contained in this notice, the name of a copyright holder shall not be used in advertising or otherwise to promote the sale, use or other dealings in this Software without prior written authorization of the copyright holder.

### **unzip**

This is version 2005-Feb-10 of the Info-ZIP copyright and license. The definitive version of this document should be available at <ftp://ftp.info-zip.org/pub/infozip/license.html> indefinitely.

Copyright (c) 1990-2005 Info-ZIP. All rights reserved.

For the purposes of this copyright and license, "Info-ZIP" is defined as the following set of individuals:

Mark Adler, John Bush, Karl Davis, Harald Denker, Jean-Michel Dubois, Jean-loup Gailly, Hunter Goatley, Ed Gordon, Ian Gorman, Chris Herborth, Dirk Haase, Greg Hartwig, Robert Heath, Jonathan Hudson, Paul Kienitz, David Kirschbaum, Johnny Lee, Onno van der Linden, Igor Mandrichenko, Steve P. Miller, Sergio Monesi, Keith Owens, George Petrov, Greg Roelofs, Kai Uwe Rommel, Steve Salisbury, Dave Smith, Steven M. Schweda, Christian Spieler, Cosmin Truta, Antoine Verheijen, Paul von Behren, Rich Wales, Mike White.

This software is provided "as is," without warranty of any kind, express or implied. In no event shall Info-ZIP or its contributors be held liable for any direct, indirect, incidental, special or consequential damages arising out of the use of or inability to use this software.

Permission is granted to anyone to use this software for any purpose, including commercial applications, and to alter it and redistribute it freely, subject to the following restrictions:

1. Redistributions of source code must retain the above copyright notice, definition, disclaimer, and this list of conditions.
2. Redistributions in binary form (compiled executables) must reproduce the above copyright notice, definition, disclaimer, and this list of conditions in documentation and/or other materials provided with the distribution. The sole exception to this condition is redistribution of a standard UnZipSFX binary (including SFXWiz) as part of a self-extracting archive; that is

permitted without inclusion of this license, as long as the normal SFX banner has not been removed from the binary or disabled.

3. Altered versions--including, but not limited to, ports to new operating systems, existing ports with new graphical interfaces, and dynamic, shared, or static library versions--must be plainly marked as such and must not be misrepresented as being the original source. Such altered versions also must not be misrepresented as being Info-ZIP releases--including, but not limited to, labeling of the altered versions with the names "Info-ZIP" (or any variation thereof, including, but not limited to, different capitalizations), "Pocket UnZip," "WiZ" or "MacZip" without the explicit permission of Info-ZIP. Such altered versions are further prohibited from misrepresentative

use of the Zip-Bugs or Info-ZIP e-mail addresses or of the Info-ZIP URL(s).

4. Info-ZIP retains the right to use the names "Info-ZIP," "Zip," "UnZip," "UnZipSFX," "WiZ," "Pocket UnZip," "Pocket Zip," and "MacZip" for its own source and binary releases.

## Software update

The Infotainment system can download and install selected software updates over a wireless connection.

### Notice

The availability of these over-the-air vehicle software updates varies by vehicle and country. Find more information on our home page.

## Internet connection

Downloading over-the-air vehicle software updates requires internet connectivity, which can be accessed through the vehicle's built-in OnStar

connection or another password-protected Wi-Fi hotspot, e.g. provided by a mobile phone.

To connect the Infotainment system to a hotspot, select **Settings** on the home screen, **Wi-Fi** and then **Manage Wi-Fi Networks**. Select the desired Wi-Fi network, and follow the on-screen prompts.

## Updates

The system will prompt for certain updates to be downloaded and installed. There is also an option to check for updates manually.

To manually check for updates, select **Settings** on the home screen, **Software Information** and then **System Update**. Follow the on-screen prompts.

### Notice

Steps for downloading and installing updates may vary by vehicle.

### Notice

During the installation process, the vehicle may not be operational.

## Registered trademarks

### Apple Inc.

Apple CarPlay™ is a trademark of Apple Inc.

App Store® and iTunes Store® are registered trademarks of Apple Inc.

iPhone®, iPod®, iPod touch®, iPod nano®, iPad® and Siri® are registered trademarks of Apple Inc.

### Bluetooth SIG, Inc.

Bluetooth® is a registered trademark of Bluetooth SIG, Inc.

### DivX, LLC

DivX® and DivX Certified® are registered trademarks of DivX, LLC.

### EnGIS Technologies, Inc.

BringGo® is a registered trademark of EnGIS Technologies, Inc.

### Google Inc.

Android™ and Google Play™ Store are trademarks of Google Inc.

### Stitcher Inc.

Stitcher™ is a trademark of Stitcher, Inc.

Verband der Automobilindustrie e.V. AdBlue® is a registered trademark of the VDA.

## Vehicle data recording and privacy

### Event data recorders

#### Data storage modules in the vehicle

A large number of electronic components of your vehicle contain data storage modules temporarily or permanently storing technical data about the condition of the vehicle, events and errors. In general, this technical information documents the condition of parts, modules, systems or the environment:

- operating conditions of system components (e.g. filling levels)
- status messages of the vehicle and its single components (e.g. number of wheel revolutions / rotational speed, deceleration, lateral acceleration)
- dysfunctions and defects in important system components



- vehicle reactions in particular driving situations (e.g. inflation of an airbag, activation of the stability regulation system)
- environmental conditions (e.g. temperature)

These data are exclusively technical and help identifying and correcting errors as well as optimising vehicle functions.

Motion profiles indicating travelled routes cannot be created with these data.

If services are used (e.g. repair works, service processes, warranty cases, quality assurance), employees of the service network (manufacturer included) are able to read out this technical information from the event and error data storage modules applying special diagnostic devices. If required, you will receive further information at these workshops. After an error has been corrected, the data are deleted from the error storage module or they are constantly overwritten.

When using the vehicle, situations may occur in which these technical data related to other information (accident report, damages on the vehicle, witness statements etc.) may be associated with a specific person - possibly, with the assistance of an expert.

Additional functions contractually agreed upon with the client (e.g. vehicle location in emergency cases) allow the transmission of particular vehicle data from the vehicle.

## Radio Frequency Identification (RFID)

RFID technology is used in some vehicles for functions such as tyre pressure monitoring and ignition system security. It is also used in connection with conveniences such as radio remote controls for door locking/unlocking and starting, and in-vehicle transmitters for garage door openers. RFID technology in Vauxhall vehicles does not use or record personal information or link with any other Vauxhall system containing personal information.

# Index

## A

Accessories and vehicle modifications .....	202
Active emergency braking.....	170
Active head restraints.....	45
Adaptive cruise control.....	99, 162
AdBlue.....	97, 143
Adjustable air vents .....	131
Advanced parking assist.....	177
Airbag and belt tensioners .....	93
Airbag deactivation .....	60, 94
Airbag label.....	55
Airbag system .....	55
Air conditioning regular operation .....	132
Air conditioning system .....	124
Air intake .....	132
Air vents.....	131
Antilock brake system .....	150
Antilock brake system (ABS) .....	95
Anti-theft alarm system .....	35
Anti-theft locking system .....	35
Appearance care.....	231
Armrest.....	50, 51
Ashtrays .....	86
Automatic anti-dazzle .....	39
Automatic light control .....	112
Automatic locking .....	28
Automatic transmission .....	146

Autostop.....	98, 139
Auxiliary heater.....	131

## B

Battery discharge protection .....	122
Battery voltage .....	104
BlueInjection.....	143
Bonnet .....	204
Brake and clutch fluid.....	235
Brake and clutch system .....	95
Brake assist .....	153
Brake fluid .....	207
Brakes .....	150, 207
Breakdown.....	229
Bulb replacement .....	210

## C

Capacities .....	245
Catalytic converter .....	143
Central locking system .....	24
Centre console lighting .....	121
Centre console storage .....	69
Changing tyre and wheel size ..	220
Charging system .....	94
Child locks .....	29
Child restraint installation locations .....	64
Child restraints.....	61
Child restraint systems .....	61
Cigarette lighter .....	86
Climate control .....	15

Climate control systems.....	123
Clock.....	83
Collision damage repair.....	251
Control indicators.....	92
Control of the vehicle .....	134
Controls.....	79
Convex shape .....	38
Coolant and antifreeze.....	235
Cruise control .....	99, 158
Cupholders .....	68
Curtain airbag system .....	59
Curve lighting.....	115

**D**

Danger, Warnings and Cautions ...	4
Daytime running lights .....	115
Declaration of conformity.....	248
DEF.....	143
Deflation detection system.....	97
Diesel exhaust fluid.....	143
Diesel fuel system bleeding .....	209
Diesel particle filter.....	97, 142
Door open .....	99
Doors.....	30
Driver alert.....	192
Driver assistance systems.....	158
Driver Information Centre.....	99
Driving characteristics and towing tips .....	197
Driving hints.....	134

**E**

Electric adjustment .....	38
Electric parking brake... 95, 150, 151	
Electric parking brake fault.....	95
Electronic climate control system	126
Electronic driving programmes ..	148
Electronic key system.....	23
Electronic Stability Control and Traction Control system....	96, 153
End-of-life vehicle recovery .....	204
Engine coolant .....	206
Engine coolant temperature .....	96
Engine coolant temperature gauge .....	91
Engine data .....	243
Engine exhaust .....	142
Engine identification.....	239
Engine oil .....	205, 235, 240
Engine oil pressure .....	97
Entry lighting .....	121
Event data recorders.....	254
Exit lighting .....	122
Exterior care .....	231
Exterior light .....	98
Exterior lighting .....	12, 112
Exterior mirrors.....	38

**F**

Fault .....	148
First aid.....	75

First aid kit .....	75
Fixed air vents .....	132
Fog light .....	98
Fog lights .....	211
Folding mirrors .....	38
Forward collision alert.....	169
Front airbag system .....	58
Front fog lights .....	119
Front pedestrian protection.....	173
Front seats.....	45
Fuel.....	193
Fuel consumption - CO <sub>2</sub> - Emissions .....	196
Fuel for diesel engines .....	194
Fuel for petrol engines .....	193
Fuel gauge .....	91

**G**

Gauges.....	89
Gear shifting.....	96
General information .....	197
Glass panel .....	43
Glovebox .....	68
Glovebox cooler .....	132

**H**

Halogen headlights .....	210
Hazard warning flashers .....	118
Headlight flash .....	114
Headlight range adjustment .....	114
Headlights.....	112

Head restraint adjustment .....	8
Head restraints .....	44
Heated mirrors .....	39
Heated rear window .....	41
Heated steering wheel .....	79
Heated windscreen.....	42
Heating .....	50, 51
Heating and ventilation system .	123
High beam .....	98, 113
High beam assist.....	98, 113
Hill start assist .....	153
Horn .....	13, 80

**I**

Identification plate .....	238
Ignition switch positions .....	134
Immobiliser .....	37
Indicators.....	89
Inductive charging.....	85
Info display.....	101
Instrument cluster .....	87
Instrument panel illumination .....	215
control .....	120
Instrument panel overview .....	10
Interior care .....	233
Interior lighting.....	120
Interior lights .....	120, 215
Interior mirrors.....	39

Interruption of power supply .....	149
Introduction .....	3

**J**

Jump starting .....	228
---------------------	-----

**K**

Keys .....	21
Keys, locks.....	21

**L**

Lane departure warning.....	96, 188
Lane keep assist.....	96, 190
Lashing eyes .....	73
LED headlights.....	98, 115, 211
Lighting features.....	121
Light switch .....	112
Load compartment .....	30, 69
Load compartment cover .....	71
Loading information .....	76
Low fuel .....	98

**M**

Malfunction indicator light .....	94
Manual anti-dazzle .....	39
Manual mode .....	148
Manual seat adjustment.....	46
Manual transmission .....	149
Mirror adjustment .....	9
Misted light covers .....	120

**N**

New vehicle running-in .....	134
Number plate light .....	215

**O**

Object detection systems.....	174
Odometer .....	90
Oil, engine.....	235, 240
OnStar.....	108
Outside temperature .....	82
Overrun cut-off .....	138

**P**

Panoramic view system.....	184
Parking .....	19, 141
Parking assist .....	174
Parking brake .....	151
Parking lights .....	119
Particulate filter.....	142
Performance .....	244
Performing work .....	204
Pollen filter .....	132
Power button.....	135
Power outlets .....	84
Power saving mode.....	136
Power seat adjustment .....	48
Power windows .....	40
Preheating .....	97
Puncture.....	224

<b>Q</b>			
Quickheat.....	131		
<b>R</b>			
Radio Frequency Identification (RFID).....	255		
Radio remote control .....	22		
Rain sensor.....	98		
REACH.....	251		
Reading lights .....	121		
Rear floor storage cover .....	72		
Rear fog light .....	98, 119		
Rear seats.....	51		
Rear view camera .....	187		
Rear window wiper/washer .....	82		
Recommended fluids and lubricants .....	235, 240		
Refuelling .....	195		
Registered trademarks.....	254		
Reversing lights .....	120		
Ride control systems.....	153		
Roller blinds .....	42		
Roof.....	43		
Roof load.....	76		
Roof rack .....	75		
<b>S</b>			
Safety net .....	73		
Seat adjustment .....	7		
Seat belt .....	8		
Seat belt reminder .....	93		
Seat belts .....	52		
Seat heating.....	50		
Seat heating, rear.....	51		
Seat position .....	45		
Selective catalytic reduction.....	143		
Selective ride control.....	155		
Selector lever .....	147		
Service .....	132, 234		
Service display .....	91		
Service information .....	234		
Side airbag system .....	59		
Side blind spot alert.....	182		
Sidelights.....	112		
Side turn signal lights .....	215		
Software acknowledgement.....	251		
Software update.....	253		
Spare wheel .....	227		
Speed limiter.....	99, 160		
Speedometer .....	89		
Sport mode .....	157		
Starting and operating.....	134		
Starting off .....	17		
Starting the engine .....	137		
Steering.....	134		
Steering wheel adjustment .....	9, 79		
Steering wheel controls .....	79		
Stop engine.....	94		
Stop-start system.....	139		
Storage.....	68		
Storage compartments.....	68		
Sunvisor lights .....	121		
Sun visors .....	42		
Symbols .....	4		
System check.....	95		
<b>T</b>			
Tachometer .....	90		
Tailgate.....	30		
Tail lights .....	212		
Three-point seat belt .....	53		
Tools .....	216		
Tow bar.....	197		
Towing.....	197, 229		
Towing another vehicle .....	230		
Towing equipment .....	198		
Towing the vehicle .....	229		
Trailer coupling.....	197		
Trailer stability assist .....	200		
Trailer towing .....	197		
Transmission .....	17		
Transmission display .....	146		
Tread depth .....	219		
Trip odometer .....	90		
Turn and lane-change signals ..	118		
Turn signal .....	93		
Tyre chains .....	221		
Tyre deflation detection system .	218		
Tyre designations .....	217		
Tyre pressure .....	217		

Tyre pressures .....	247
Tyre repair kit .....	221

## U

Ultrasonic parking assist.....	174
Upholstery.....	233
Using this manual .....	3

## V

Valet mode.....	101
Vehicle battery .....	207
Vehicle checks.....	204
Vehicle data.....	240
Vehicle data recording and privacy.....	254
Vehicle detected ahead.....	99
Vehicle dimensions .....	245
Vehicle Identification Number ...	238
Vehicle jack.....	216
Vehicle messages .....	103
Vehicle personalisation .....	104
Vehicle security.....	35
Vehicle specific data .....	3
Vehicle storage.....	203
Vehicle tools.....	216
Vehicle unlocking .....	6
Vehicle weight .....	244
Ventilating.....	51
Ventilation.....	123

## W

Warning chimes .....	103
Warning lights.....	89
Warning triangle .....	75
Washer and wiper systems .....	13
Washer fluid .....	207
Wheel changing .....	224
Wheel covers .....	220
Wheels and tyres .....	217
Windows.....	40
Windscreen.....	40
Windscreen wiper/washer .....	80
Winter tyres .....	217
Wiper blade replacement .....	209

Copyright by General Motors UK Ltd.

The information contained in this publication is effective as of the date indicated below. General Motors UK Ltd. reserves the right to make changes to the technical specifications, features and design of the vehicles relative to the information contained in this publication, as well as changes to the publication itself.

Edition: August 2017, General Motors UK Ltd.

Printed on chlorine-free bleached paper.

ID-VGDAORIE1708-en

