

# ENGINE ELECTRICAL

## CONTENTS

18196092J01

|  |    |   |    |
|--|----|---|----|
| <b>CHARGING SYSTEM</b> .....   | 2  | Ignition Coil (With Built-in Ignition Power Transistor) Check <1.8L engine> ..... | 36 |
| <b>GENERAL INFORMATION</b> .....                                     | 2  | Ignition Failure Sensor Check <1.8L engine> .....                                 | 37 |
| <b>GENERATOR</b> .....   | 13 | Ignition Power Transistor Continuity Check <1.5L engine> .....                    | 36 |
| <b>ON-VEHICLE SERVICE</b> .....                                      | 6  | Ignition Primary Voltage Waveform Check .....                                     | 43 |
| Generator Output Line Voltage Drop Test .....                        | 6  | Ignition Secondary Voltage Waveform Check .....                                   | 36 |
| Output Current Test .....  | 7  | Spark Plug Cable Test .....   | 35 |
| Regulated Voltage Test .....   | 3  | Spark Plug Cable Resistance Check .....   | 37 |
| Waveform Check Using an Analyzer .....                               | 11 | Spark Plug Check and Cleaning .....   | 37 |
| <b>SERVICE SPECIFICATIONS</b> .....                                  | 3  | Spark Plug Test .....   | 35 |
| <b>TROUBLESHOOTING</b> .....   | 4  | <b>SERVICE SPECIFICATIONS</b> .....   | 33 |
| <b>IGNITION SYSTEM</b> .....   | 31 | <b>SPECIAL TOOLS</b> .....  | 34 |
| <b>CAMSHAFT POSITION SENSOR AND CRANKSHAFT POSITION SENSOR</b> ..... | 50 | <b>TROUBLESHOOTING</b> .....  | 34 |
| <b>DISTRIBUTOR &lt;1.5L engine&gt;</b> .....                         | 49 | <b>STARTING SYSTEM</b> .....  | 19 |
| <b>GENERAL INFORMATION</b> .....                                     | 31 | <b>GENERAL INFORMATION</b> .....  | 19 |
| <b>IGNITION SYSTEM &lt;1.6L engine&gt;</b> .....                     | 47 | <b>ON-VEHICLE SERVICE</b> .....   | 21 |
| <b>&lt;1.8L engine&gt;</b> .....                                     | 48 | Starter Relay Continuity Check <MT> .....   | 21 |
| <b>ON-VEHICLE SERVICE</b> .....                                      | 35 | <b>SERVICE SPECIFICATIONS</b> .....   | 20 |
| Camshaft Position Sensor and Crankshaft Position Sensor Check .....  | 38 | <b>STARTER MOTOR</b> .....  | 27 |
| Ignition Coil Check <1.5L engine> .....                              | 35 | <b>TROUBLESHOOTING</b> .....  | 20 |

# CHARGING SYSTEM

16100010471

## GENERAL INFORMATION

The charging system is a system which charges the battery with the generator output to keep the

battery charged at a constant level during varying electrical load.

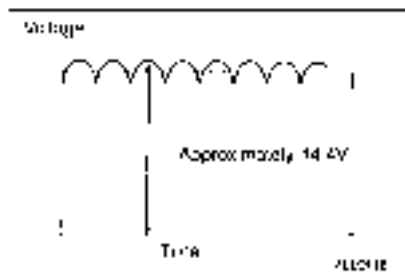

### Operation

Rotation of the excited field coil generates AC voltage in the stator.

The alternating current is rectified through diodes to DC voltage having a waveform shown in the illustration at left.

The average output voltage fluctuates slightly with the generator load condition.

When the ignition switch is turned on, current flows and excites the field coil initially.

When the stator coil begins to generate power after the engine is started, the field coil is excited by the output current of the stator coil.

The generator output voltage rises as the field current increases and it falls as the field current decreases. When the battery voltage (generator  $B$  terminal voltage) reaches a regulated voltage

of approximately 14.4V, the field current is cut off.

When the battery voltage drops below the regulated voltage, the voltage regulator regulates the output voltage to a constant level by controlling the field current.

In addition, when the field current is constant, the generator output voltage rises as the engine speed increases.

## CHARGING WARNING LIGHT OPERATION

### When engine is stopped

When the ignition switch is switched to the "ON" position, electricity flows from the "L" terminal of the generator to the rotor coil (field coil), and at the same time the charging warning light illuminates.

### When engine is being started/has started

When the engine is started, charging voltage is applied to the "L" terminal of the generator, with the result that the charging warning light is extinguished.

In addition, because battery voltage is applied to the "B" terminal of the generator, this battery voltage

is monitored at the IC voltage regulator, thus switching ON and OFF the current to the rotor coil (field coil) and thereby controlling the output voltage of the generator.

Power is supplied to each load from the "B" terminal of the generator.

### NOTE

The generator relay functions as a back-up for the flow of electricity to the rotor coil (field coil) if there is a disconnection or damaged wiring of the charging warning light.

## SYSTEM DIAGRAM

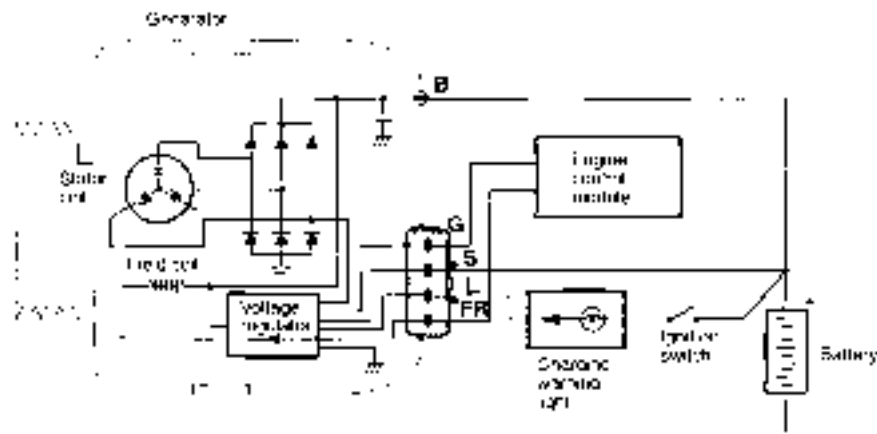

16-10211

## GENERATOR SPECIFICATIONS

| Items             | 1.5L Engine              | 1.8L Engine             |
|-------------------|--------------------------|-------------------------|
| Type              | Battery voltage sensing  | Battery voltage sensing |
| Identifier No.    | A2TA5191                 | A2TA5301                |
| Part No.          | MD326536                 | MD317862                |
| Rated output (VA) | 1200                     | 1200                    |
| Voltage regulator | Electronic built-in type | External built-in type  |

## SERVICE SPECIFICATIONS

1610000139

| Items   | Standard value    | Limit                         |
|---|-------------------|-------------------------------|
| Regulated voltage<br>(Ambient temp.: at voltage regulation) |                   |                               |
| -20°C (-4°F)  | 14.2-15.4         | -                             |
| 20°C (68°F)   | 13.9-14.9         | -                             |
| 60°C (140°F)  | 13.4-14.6         | -                             |
| 80°C (176°F)  | 13.1-14.3         | -                             |
| Rotor coil resistance (Ω)                                   | Approximately 3-5 | -                             |
| Generator output line voltage drop (at 30A/V)               | -                 | max. 0.0                      |
| Output current  | -                 | 70% of nominal output current |

## TROUBLESHOOTING

10-10-10-10-10

### TROUBLESHOOTING HINTS

1. Charging warning light does not go on when the ignition switch is turned to "ON" before the engine starts.
  - Check the bulb.
2. Charging warning light fails to go off once the engine starts.
  - Check the IC voltage regulator (located inside the generator).
3. Discharged or overcharged battery.
  - Check the IC voltage regulator (located inside the generator).
4. The charging warning light illuminates dimly.
  - Check the diode (within the combination meter) for a short-circuit.

## TROUBLESHOOTING GUIDE

The charging system troubleshooting guide is shown in the following chart.

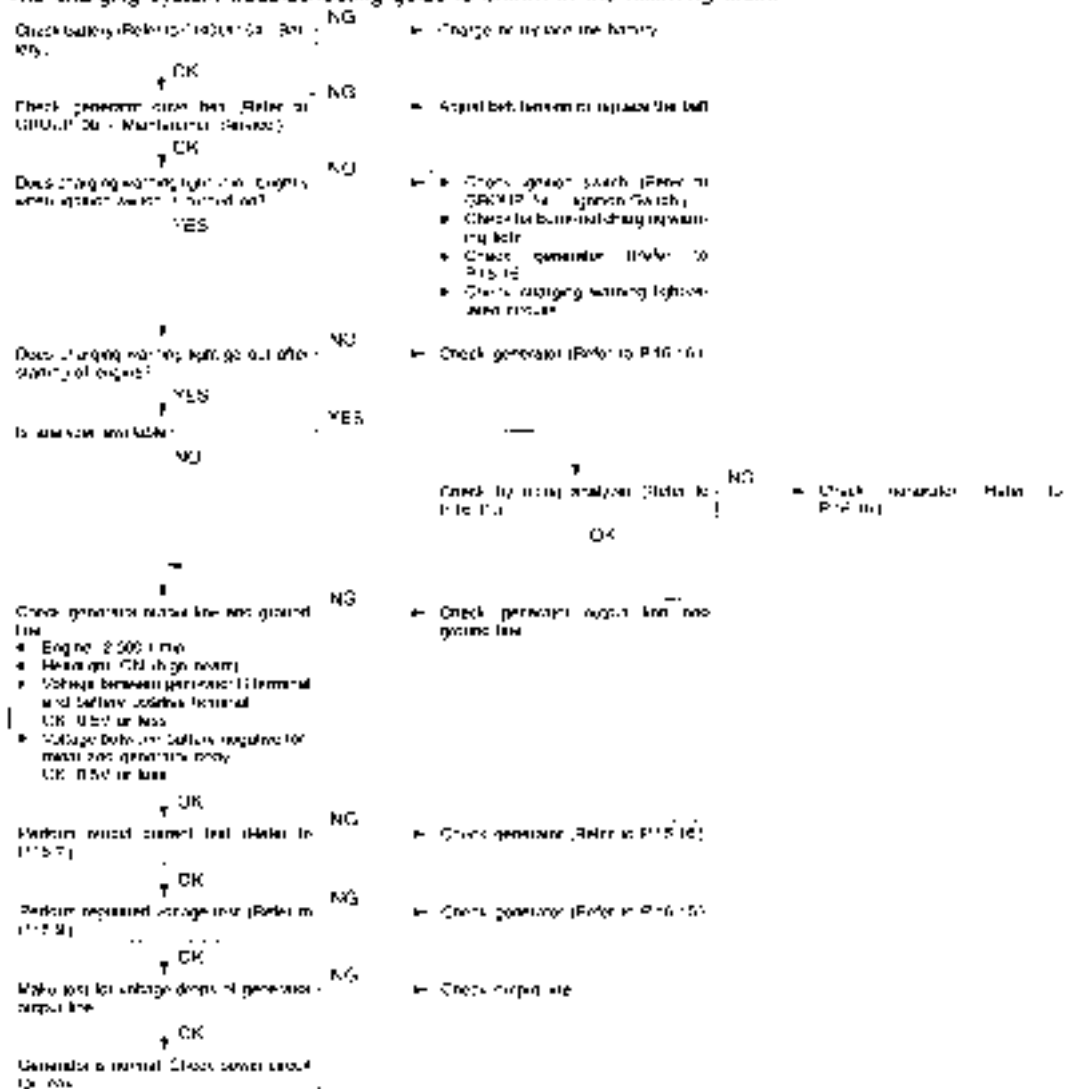

## ON-VEHICLE SERVICE

11130966A

## GENERATOR OUTPUT LINE VOLTAGE DROP TEST

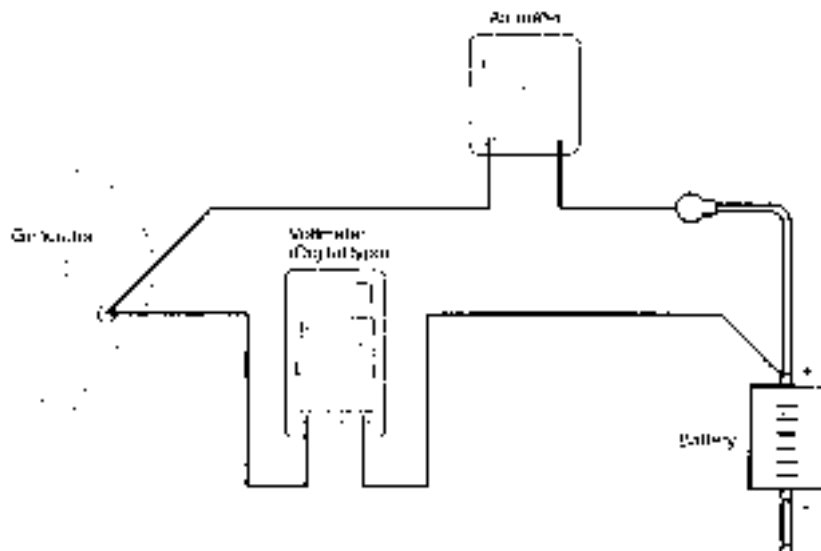

6E40935

This test determines the condition of the wiring from the generator "B" terminal to the battery (+) terminal including the fusible link.

(1) Be sure to check the following before testing:

- Generator installation and wiring connections
- Generator drive belt tension (Refer to GROUP 00 Maintenance Service)
- Fusible link
- Abnormal noise from the generator while the engine is running

(2) Turn the ignition switch to the OFF position.

(3) Disconnect the negative battery cable.

(4) Disconnect the generator output wire from the generator "B" terminal. Connect a DC test ammeter with a range of 0 - 100 A in series between the "B" terminal and the disconnected output wire. (Connect the (+) end of the

ammeter to the "B" terminal. Connect the (-) lead of the ammeter to the disconnected output wire.)

## NOTE

An inductive type ammeter which enables measurements to be taken without disconnecting the generator output wire is recommended.

Using this equipment will lessen the possibility of a voltage drop caused by a loose "B" terminal connection.

- (5) Connect a digital type voltmeter between the generator "B" terminal and the battery (+) terminal. (Connect the (+) lead of the voltmeter to the "B" terminal. Connect the (-) lead of the voltmeter to the battery (+) cable.)

- (6) Reconnect the negative battery cable.
- (7) Connect a tachmeter or the scan tool.
- (8) Leave the load open and connect a tachmeter.
- (9) Start the engine.
- (10) With the engine running at approx. 2500 r/min, turn the headlights and other lights on and off to adjust the generator load on the ammeter slightly above 30 A. Decrease the engine speed gradually until the value displayed on the ammeter is 30 A. Take a reading of the value displayed on the voltmeter at this time.

Limit: max. 0.3 V

#### NOTE

When the generator output is high and the value displayed on the ammeter does not decrease until 30A, set the value to 40A. Read

the value displayed on the voltmeter. In this case the limit becomes max. 0.4V.

- (11) If the value displayed on the voltmeter is still above the limit, a malfunction in the generator output wire may exist. Check the wiring between the generator 'B' terminal and the battery (-) terminal (including fusible link). If a terminal is not sufficiently tight or if the harness has become discolored due to overheating, repair, then test again.
- (12) After the test, run the engine at idle.
- (13) Turn off all lights and turn the ignition switch in the OFF position.
- (14) Disconnect the tachmeter or the scan tool.
- (15) Disconnect the negative battery cable.
- (16) Disconnect the ammeter and voltmeter.
- (17) Connect the generator output wire to the generator 'B' terminal.
- (18) Connect the negative battery cable.

## OUTPUT CURRENT TEST

4-92-30-61

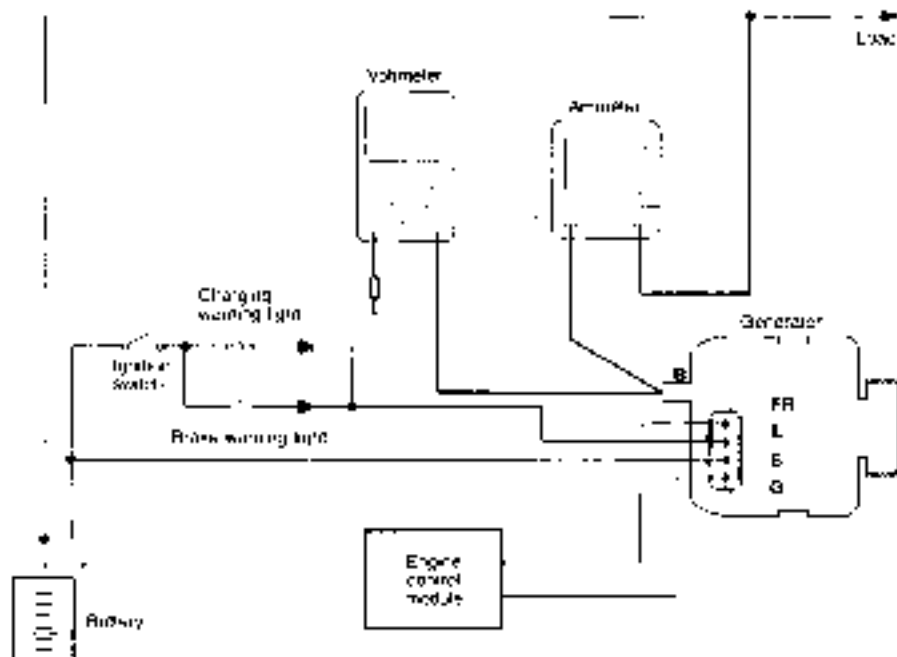

This test determines if the generator output current is normal.

- (1) Before testing, be sure to check the following:
- Generator installation and wiring connections
  - Battery (Refer to GROUP 54 - Battery.)

#### NOTE

The battery used should be slightly discharged. The load provided by a fully charged battery is insufficient for an accurate test.

- Generator drive belt tension (Refer to GROUP 11 - Maintenance Service.)
  - Fusible link
  - Abnormal noise from the generator while the engine is running.
- (2) Turn the ignition switch to the OFF position.
- (3) Disconnect the negative battery cable.
- (4) Disconnect the generator output wire from the generator "B" terminal. Connect a DC test ammeter with a range of 0-100 A in series between the "B" terminal and the disconnected output wire. (Connect the (+) lead of the ammeter to the "B" terminal. Connect the (-) lead of the ammeter to the disconnected output wire.)

#### WARNING

Never use clips to connect the leads. Loose connections (e.g. using clips) will lead to a serious accident because of high current.

#### NOTE

An inductive-type ammeter which enables measurements to be taken without disconnecting the generator output wire is recommended.

- (5) Connect a voltmeter with a range of 0-20 V between the generator "B" terminal and the ground. (Connect the (+) lead of the voltmeter to the "B" terminal, and then connect the (-) lead of the voltmeter to the ground.)
- (6) Connect the negative battery cable.
- (7) Connect a tachometer to the scan tool.
- (8) Leave the hood open.
- (9) Check that the reading on the voltmeter is equal to battery voltage.

#### NOTE

If the voltage is 0 V, the cause is probably an open circuit in the wire or fusible link between the generator "B" terminal and the battery (+) terminal.

- (10) Start the engine, and turn the headlights on.

- (11) Switch the headlights to high beam, turn the heater blower switch to high, increase the engine speed to approximately 2500 rpm, and read the maximum current output displayed on the ammeter.

Limit: 70% of nominal output current

#### NOTE

- For the nominal current output, refer to the Generator Specifications.
- Because the current from the battery will soon drop after the engine is started, Steps (10) and (11) should be carried out as quickly as possible in order to obtain the maximum current output value.
- The current output value will depend on the electrical load and the temperature of the generator body.
- If insufficient electrical load is used while testing, the specified level of current may not be output even though the generator is normal. In such cases, increase the electrical load by leaving the headlights on with the engine off to discharge the battery before testing.
- The specified level of current also may not be output if the temperature of the generator body and/or ambient temperature is too high. In such cases, allow the generator to cool before testing.

- (12) The reading on the ammeter should be above the limit value. If the reading is below the limit value and the generator output wire is normal, remove the generator from the engine and check the generator.
- (13) Run the engine at idle speed after the test.
- (14) Turn the ignition switch to the OFF position.
- (15) Disconnect the tachometer or the scan tool.
- (16) Disconnect the negative battery cable.
- (17) Disconnect the ammeter and voltmeter.
- (18) Connect the generator output wire to the generator "B" terminal.
- (19) Connect the negative battery cable.





## NOTE

If the output current is 12.3 v, the terminal G may be grounded. Refer to GROUP 13A - Troubleshooting to check the generator 'G' terminal related circuit.

(15) After the test, lower the engine speed to the idle speed.

(16) Turn the ignition switch to the OFF position.

(17) Disconnect the tachometer or the scan tool.

(18) Disconnect the negative battery cable.

(19) Disconnect the ammeter and voltmeter.

(20) Connect the generator output wire to the generator 'B' terminal.

(21) Connect the negative battery cable.

## Voltage Regulation Table

| Battery ambient temperature C ; F | Standard value V |
|-----------------------------------|------------------|
| 20 (68)                           | 14.2-15.1        |
| 20 (68)                           | 13.9-14.5        |
| 00 (14)                           | 13.4-14.6        |
| 30 (176)                          | 13.1-14.5        |

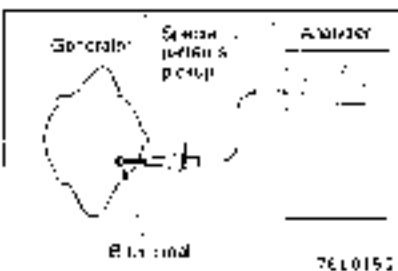

## WAVEFORM CHECK USING AN ANALYZER

16100120138

## MEASUREMENT METHOD

Connect the analyzer special patterns pick-up to the generator B terminal

## STANDARD WAVEFORM

## Observation Conditions

|                  |                                   |
|------------------|-----------------------------------|
| FUNCTION         | SPECIAL PATTERNS                  |
| PATTERN HEIGHT   | VARIABLE                          |
| VARIABLE knob    | Adjust while viewing the waveform |
| PATTERN SELECTOR | HASTE-H                           |
| Engine speed     | Just idle speed                   |

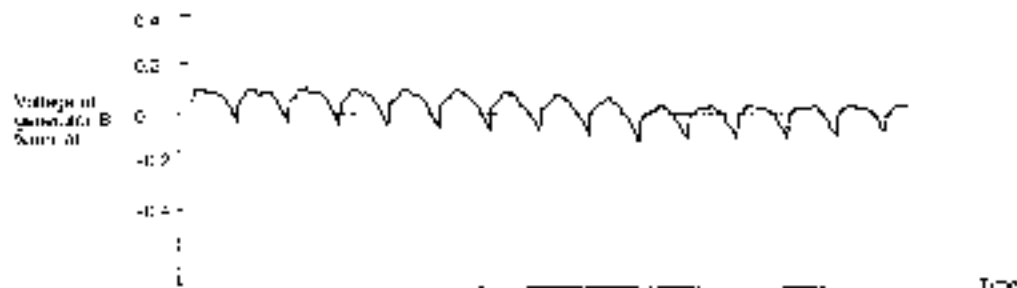

7EL0153

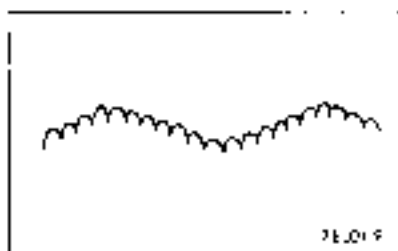



## NOTE

The voltage waveform of the generator B terminal can undulate as shown at left. This waveform is produced when the regulator operates according to fluctuations in the generator load (current), and is normal for the generator.

In addition, if the ripples are abnormally high (more than approximately 2 V when the engine is idling), the cause is probably an open circuit between the generator B terminal and the battery due to a blown fuse, and the generator itself is usually okay.

ABNORMAL WAVEFORMS EXAMPLES

- NOTE
1. The size of the waveform patterns differs largely, depending on the adjustment of the analyzer's variable knob.
  2. Identification of abnormal waveforms is easiest with a large output current (regulator not operating). These waveforms can be observed when the headlights are on.
  3. Check the condition of the charging warning light (illuminated/not illuminated). Also, check the condition of all charging system components.

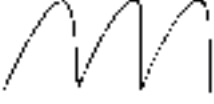
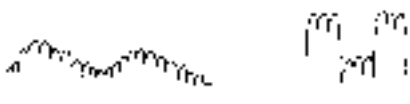
| Abnormal waveforms  | Problem cause              |
|---|----------------------------|
| <p>Example 1</p>  <p>TEL0128</p>  | Open diode                 |
| <p>Example 2</p>  <p>TEL0129</p>   | Short in diode             |
| <p>Example 3</p>  <p>TEL0130</p>   | Broken wire in stator coil |
| <p>Example 4</p>  <p>TEL0131</p>   | Short in stator coil       |
| <p>Example 5</p>  <p>Charging warning light is illuminated.</p> <p>TEL0134</p> | Open supplementary diode   |

## GENERATOR

## REMOVAL AND INSTALLATION

## Post-Installation Operation

- Adjust the 2 Coils Belt Tension (Refer to GROUP 01 - Maintenance Service.)

## &lt;1.5L Engine&gt;

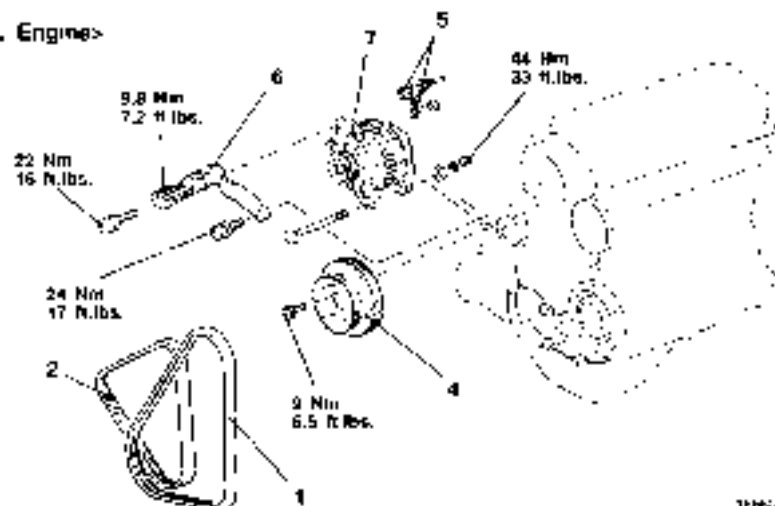

1540201

## &lt;1.8L Engine&gt;

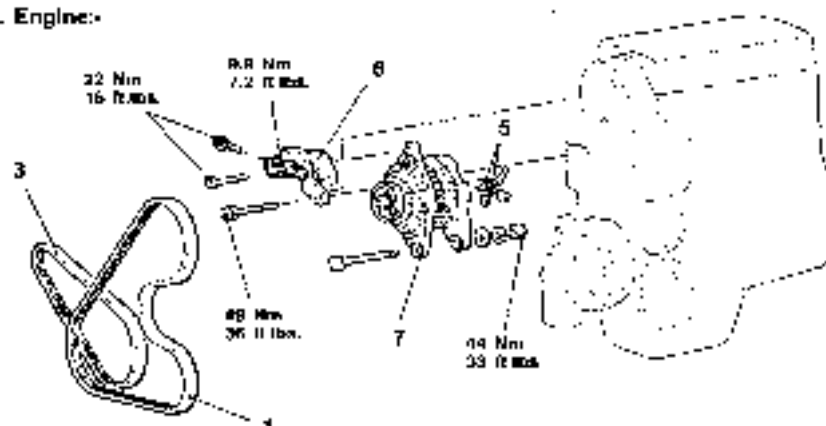

1540305

20704734

## Removal steps

- 1 Drive belt (Air conditioning compressor and power steering oil pump)
- 2 Drive belt (Generator and water pump) <1.5L Engine>
- 3 Drive belt (Generator) <1.8L Engine>
- 4 Water pump pulley <1.5L Engine>
- 5 Generator connector
- 6 Generator brace
- 7 Generator



**DISASSEMBLY SERVICE POINTS****◀A▶ FRONT BRACKET REMOVAL**

Insert a flat tip screwdriver etc., in the clearance between the front bracket assembly and stator core, to pry open and separate the stator and front bracket.

**Caution**

The stator coil could be damaged so do not insert the screwdriver too far.

**◀B▶ PULLEY REMOVAL**

Face the pulley side upward, fix the rotor with a work bench and remove the pulley.

**Caution**

Use care so that the rotor is not damaged.

**◀C▶ STATOR/REGULATOR ASSEMBLY REMOVAL**

- (1) Use a soldering iron (180 to 250 W) to unsolder the stator. This work should complete within approximately four seconds to prevent heat from transferring to the diode.
- (2) When removing the rectifier from the regulator assembly, remove the soldered sections of the rectifier.

**Caution**

1. Use care to make sure that the heat of the soldering iron is not transmitted to the diodes for a long period.
2. Use care that no undue force is exerted to the lead wires of the diode.

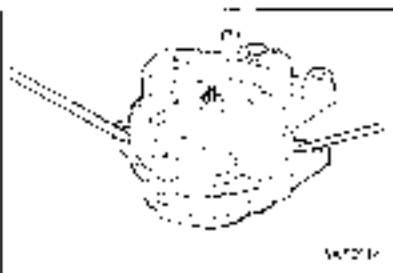

1A2014



1E10300

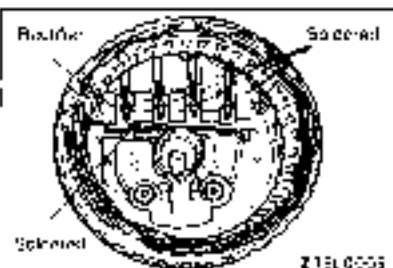

21E10005

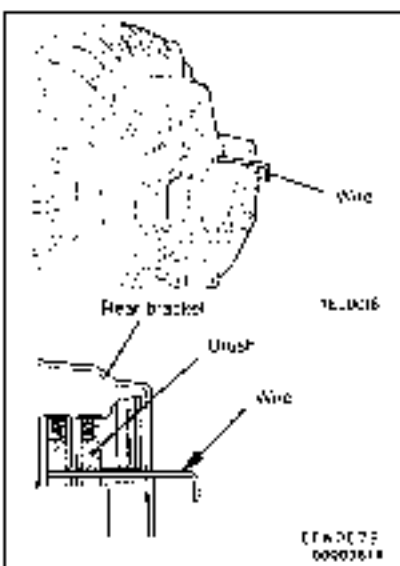

## REASSEMBLY SERVICE POINTS

### ►A◄ REGULATOR ASSEMBLY INSTALLATION

After installing the regulator assembly, insert a wire into the hole provided on the rear bracket while pressing of the brush to fix the brush.

#### NOTE

The brush is fixed when a wire is inserted, making rotor installation easier.



### ►B◄ ROTOR INSTALLATION

After installing the rotor, remove the wire used to fix the brush.

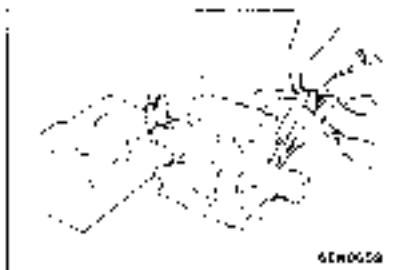

## INSPECTION

16100170100

### ROTOR CHECK

- (1) Check the continuity between the rotor coil slip rings, and replace the rotor if the resistance value is not at the standard value.

Standard value:  $3 - 5 \Omega$

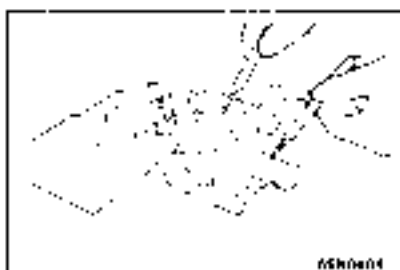

- (2) Check the continuity between the slip ring and core, and if there is continuity, replace the rotor.



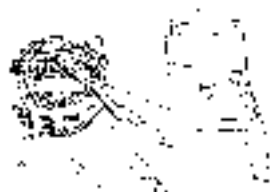

JEN0200

**STATOR CHECK**

- (1) Check the continuity between the coil leads, and if there is continuity, replace the stator.



JEN0200

- (2) Check the continuity between the coil and core, and if there is continuity, replace the stator.

**RECTIFIER CHECK**

- (1) Inspect the (+) heat sink by checking the continuity between the (+) heat sink and stator coil lead wire connection terminal using a tester probe. If there is a continuity at both, the diode is short circuited, so replace the rectifier.

- (2) Inspect the (-) heat sink by checking the continuity between the (-) heat sink and stator coil lead wire connection terminal using a tester probe. If there is a continuity at both, the diode is short circuited, so replace the rectifier.

- (3) Check the diode trio by connecting an ohmmeter to both ends of each diode and check the continuity of the three diodes. If there is a continuity at both ends, or if there is no continuity, the diode is damaged so replace the rectifier.

**BRUSH CHECK**

- (1) Measure the length of the brush protrusion (shown in this illustration), and replace the brush if the measured value is below the limit value.

**Limit 2 mm (8/16 in) or less**

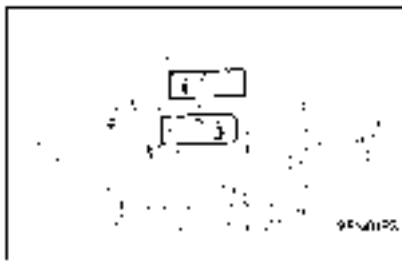

- (2) The brush can be removed if the solder of the brush lead wire is removed.
- (3) When installing a new brush, insert the brush into the holder as shown in the illustration, and then solder the lead wires.

# STARTING SYSTEM

16200 1036\*

## GENERAL INFORMATION

If the ignition switch is turned to the "START" position, current flows in the coil provided inside magnetic switch, attracting the plunger. When the plunger is attracted, the lever connected to the plunger is actuated to engage the starter clutch. On the other hand, attracting the plunger will turn on the magnetic switch, allowing the B terminal and M terminal to conduct. Thus current flows to engage the starter motor.

When the ignition switch is returned to the "ON" position after starting the engine, the starter clutch is disengaged from the ring gear.

An overrunning clutch is provided between the pin on and the armature shaft, to prevent damage to the starter.

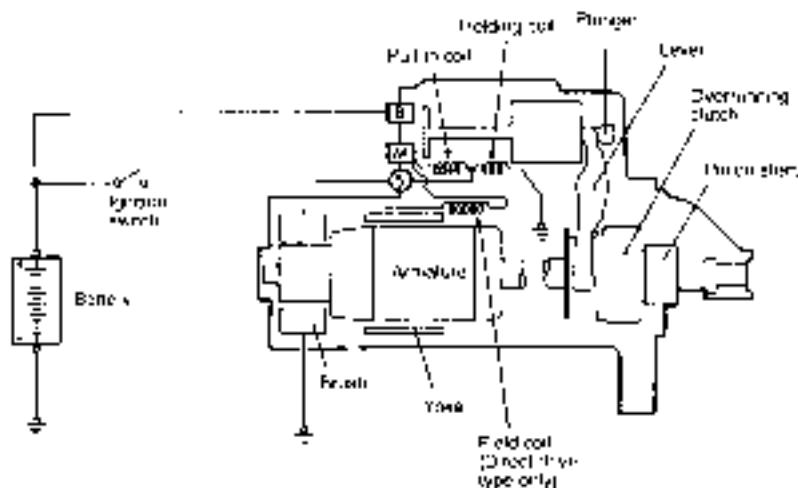

16M21\*

## STARTER MOTOR SPECIFICATIONS

| Items               | I 5L Engine  | I 5L Engine - M-1* | I 6L Engine                         |
|---------------------|--------------|--------------------|-------------------------------------|
| Type                | Direct drive | Direct drive       | Reduction drive with planetary gear |
| Identification No.  | MG1445B1     | M2144761           | MO161294                            |
| Part No.            | MD301348     | MD301350           | MD360358                            |
| Rated output kW/V   | 0.9-1.2      | 0.7-1.2            | 1.2-1.2                             |
| No. of pinion teeth | 6            | 6                  | 5                                   |

\* Engines for use in regions other than cold climates

## OPERATION

- For models equipped with the M.T. the clutch pedal position switch contact is switched OFF when the clutch pedal is depressed. When the ignition switch is then switched to the "ST" position, electricity flows to the starter relay and the starter motor. The contact magnetic switch of the starter is switched ON, and the starter motor is activated.

## NOTE

If the ignition switch is switched to the "ST" position without the clutch pedal being depressed, electricity flows to the starter relay

(coil), the clutch pedal position switch (contacts) and to ground, with the result that the contacts of the starter relay are switched OFF. Because the power to the starter motor is thereby interrupted the starter motor is not activated.

- For models equipped with the A.T., when the ignition switch is switched to the "ST" position while the selector lever is at the "P" or "N" position, the contact magnetic switch of the starter is switched ON and the starter motor is activated.

## SERVICE SPECIFICATIONS

16200030125

## Direct drive type

| Items                        |                    | Standard value           | Unit         |
|------------------------------|--------------------|--------------------------|--------------|
| Free running characteristics | Terminal voltage V | 11.5                     | -            |
|                              | Current A          | 53 or less               | -            |
|                              | Speed r/min        | 5,200 or more            | -            |
| Pinion gap mm (in.)          |                    | 0.5 - 2.0 (0.020 - .079) | -            |
| Commutator runout mm (in.)   |                    | -                        | 0.05 (0.002) |
| Commutator diameter mm (in.) |                    | 37.0 (1.457)             | 31.4 (1.233) |
| Undercut depth mm (in.)      |                    | 0.5 (0.020)              | 0.2 (0.008)  |

## Reduction drive type

| Items                        |                    | Standard value           | Unit         |
|------------------------------|--------------------|--------------------------|--------------|
| Free running characteristics | Terminal voltage V | 11                       | -            |
|                              | Current A          | 90 or less               | -            |
|                              | Speed r/min        | 2,800 or more            | -            |
| Pinion gap mm (in.)          |                    | 0.5 - 2.0 (0.020 - .079) | -            |
| Commutator runout mm (in.)   |                    | -                        | 0.05 (0.002) |
| Commutator diameter mm (in.) |                    | 29.4 (1.156)             | 26.8 (1.119) |
| Undercut depth mm (in.)      |                    | 0.5 (0.020)              | 0.2 (0.008)  |

## TROUBLESHOOTING

16200070110

## TROUBLESHOOTING HINTS

- The starter motor does not operate at all.
  - Check the starter (coil).
  - Check for poor contact at the battery terminals and starter.
  - Check park-neutral position switch. <A.T.>
  - Check starter relay. <M.T.>
  - Check clutch pedal position switch. <M.T.>
- The starter motor doesn't stop.
  - Check the starter (magnetic switch).

## TROUBLESHOOTING GUIDE

The starting system troubleshooting guide is shown in the following chart:

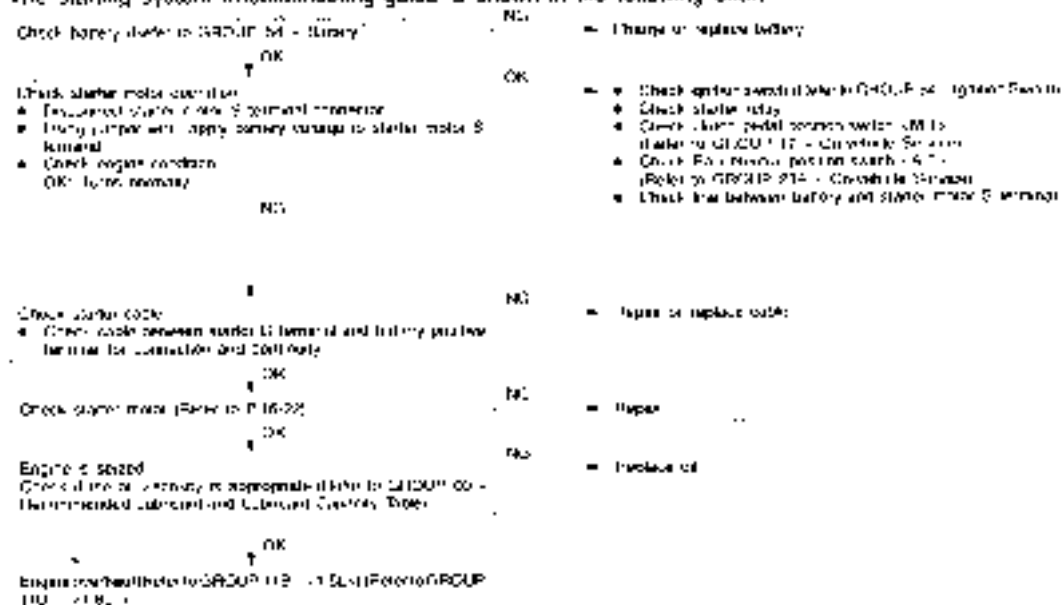

## ON-VEHICLE SERVICE

1620014-0001

## STARTER RELAY CONTINUITY CHECK &lt;M/T&gt;

1. Remove the starter relay from the relay box inside the engine compartment.
2. Set an ohmmeter and check that there is continuity when the (+) terminal of the tester is connected to terminal 4 of the starter relay and the (-) terminal is connected to terminal 2.
3. Next, check that there is no continuity when the (-) terminal is connected to terminal 2 and the (+) terminal is connected to terminal 4.
4. If the continuity checks in step 2 and 3 show a defect, replace the starter relay.

## STARTER MOTOR

162010000

## REMOVAL AND INSTALLATION

Pre-removal and Post-Installation Operation  
 Air Cleaner Removal and Installation

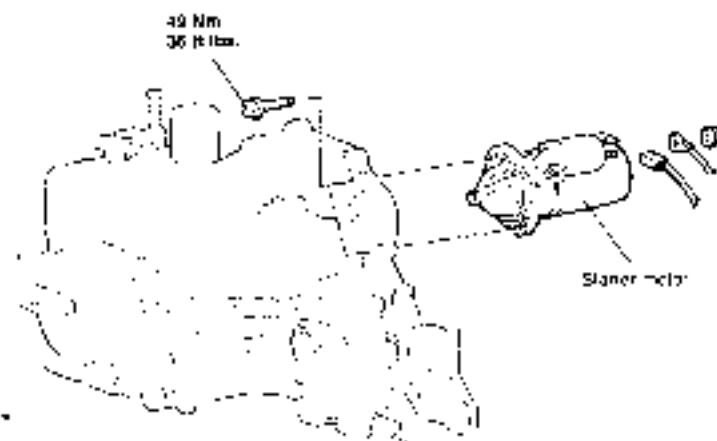

41547022

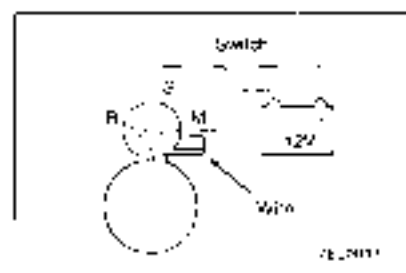

## INSPECTION

16200-1E167

## PINION GAP ADJUSTMENT

- (1) Disconnect the wire from the M terminal of the magnetic switch.
- (2) Connect a 12V battery between the S-terminal and the M-terminal.
- (3) Set the switch to 'ON', and the pinion will move out.

**Caution**

This test must be performed quickly (in less than 10 seconds) to prevent the coil from burning.

- (4) Check pinion to stopper clearance (pinion gap) with a feeler gauge.

Standard value: 0.5-2.0 mm (.020-.079 in.)

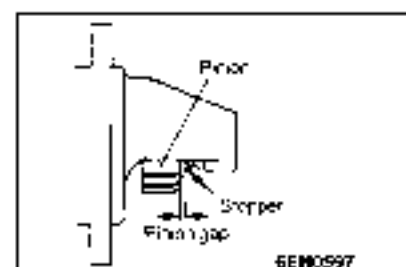



- (5) If the pinion gap is out of specification, adjust by adding or removing the gaskets between the magnetic switch and the front bracket.

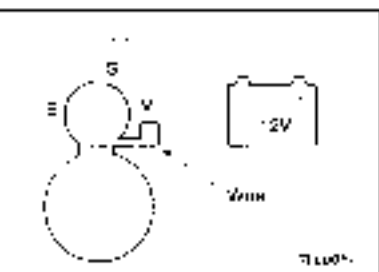

### MAGNETIC SWITCH PULL-IN TEST

- (1) Disconnect the wire from the M-terminal of the magnetic switch.
- (2) Connect a 12V battery between the S-terminal and the M-terminal.

#### Caution

This test must be performed quickly (in less than 10 seconds) to prevent coil from burning.

- (3) If the pinion moves out, the pull-in coil is good. If it doesn't, replace the magnetic switch.

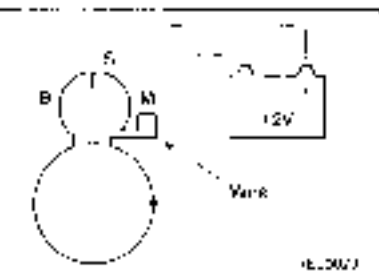

### MAGNETIC SWITCH HOLD-IN TEST

- (1) Disconnect the wire from the M-terminal of the magnetic switch.
- (2) Connect a 12V battery between the S-terminal and the body.

#### Caution

This test must be performed quickly (in less than 10 seconds) to prevent coil from burning.

- (3) Draw out the pinion to the pinion slipper by hand.
- (4) If the pinion remains out, everything is operating properly. If the pinion moves in, hold-in circuit is open. Replace the magnetic switch.

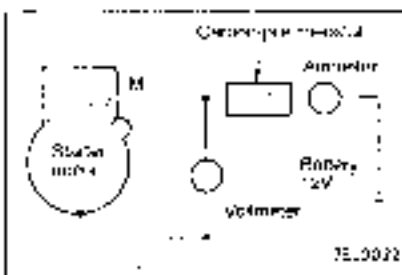
**FREE RUNNING TEST**

- (1) Place the starter motor in a vise equipped with soft jaws and connect a fully-charged 12-volt battery to starter motor as follows:
- (2) Connect a test ammeter (100 ampere scale) and carbon pile rheostat in series between the positive battery terminal and starter motor terminal.
- (3) Connect a voltmeter (15-volt scale) across the starter motor.
- (4) Rotate carbon pile to the full-resistance position.
- (5) Connect the battery cable from the negative battery terminal to the starter motor body.
- (6) Adjust the rheostat until the battery voltage shown by the voltmeter is 11.5 V (for the direct drive type) or 11 V (for reduction drive type).
- (7) Confirm that the maximum amperage is within the specifications and that the starter motor turns smoothly and freely.

**Standard value:**

60 A or less (Direct drive type)

90 A or less (Reduction drive type)

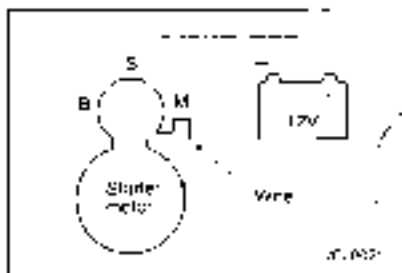
**MAGNETIC SWITCH RETURN TEST**

- (1) Disconnect the wire from the M-terminal of the magnetic switch.
- (2) Connect a 12V battery between the M-terminal and the body.

**Caution**

This test must be performed quickly (in less than 10 seconds) to prevent coil from burning.

- (3) Pull the pinion out and release. If the pinion quickly returns to its original position, everything is operating properly. If it doesn't, replace the magnetic switch.

**Caution**

Be careful not to pinch your finger when drawing out the pinion.



## DISASSEMBLY AND REASSEMBLY &lt;DIRECT DRIVE TYPE&gt;

1473C123P07

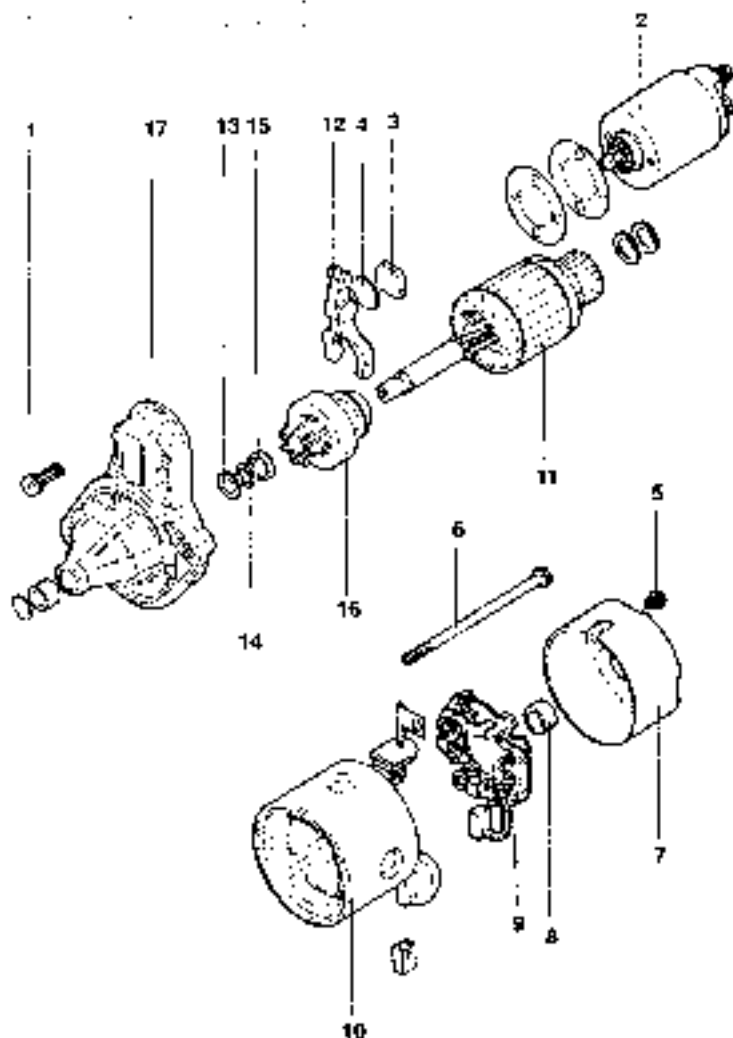

## Disassembly steps

- 1 Screw
- 2 Magnetic switch
- 3 Packing
- 4 Plate
- 5 Screw
- 6 Through drill
- 7 Rear bracket
- 8 Rear bearing

- 9 Brush holder assembly
- 10 Yoke assembly
- 11 Armature
- 12 Lever
- 13 Washer
- 14 Snap ring
- 15 Stop ring
- 16 Overrunning clutch
- 17 Front bracket

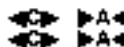

calsonic

DISASSEMBLY AND REASSEMBLY <REDUCTION DRIVE TYPE>

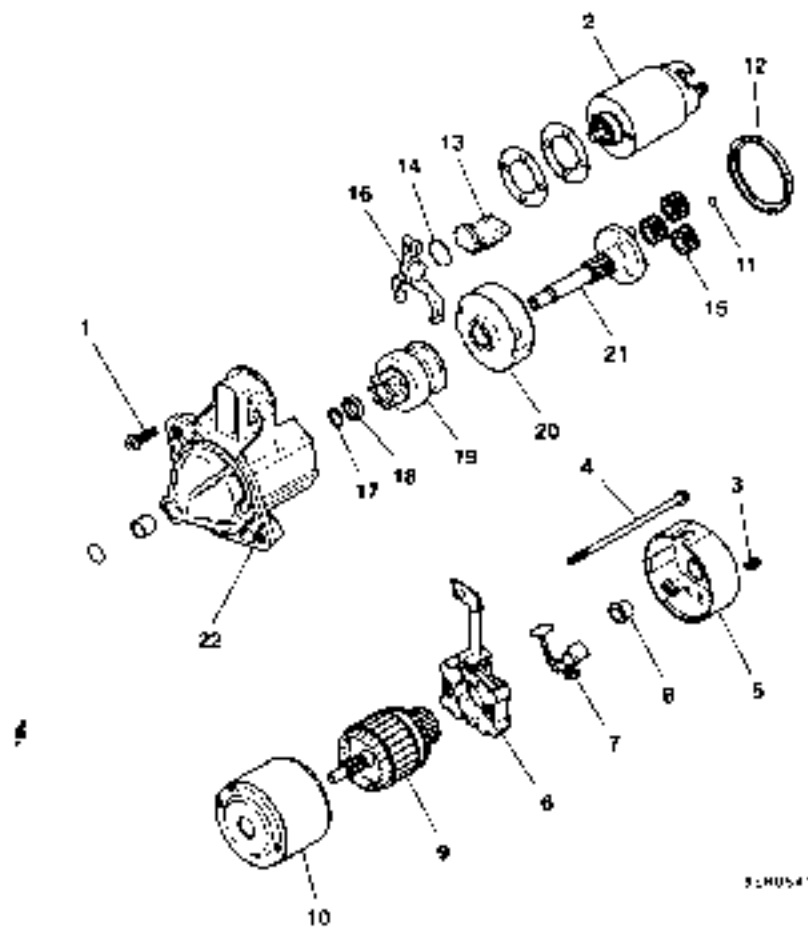

31054

Disassembly steps

- 1 Screw
- 2 Magnetic switch
- 3 Screw
- 4 Screw
- 5 Rear bracket
- 6 Brush holder
- 7 Brush
- 8 Rear bearing
- 9 Armature
- 10 Yoke assembly
- 11 Ret

- 12 Packing A
- 13 Packing B
- 14 Plate
- 15 Planetary gear
- 16 Lever
- 17 Snap ring
- 18 Stop ring
- 19 Overrunning clutch
- 20 Internal gear
- 21 Planetary gear body
- 22 Front bracket

←A→

←B→

←B→

←C→

←A→

←A→

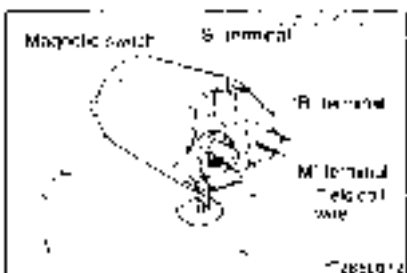
**DISASSEMBLY SERVICE POINTS****←→ MAGNETIC SWITCH REMOVAL**

Disconnect field coil wire from "M" terminal of magnetic switch.

**←→ ARMATURE/BALL REMOVAL****Caution**

When removing the armature, take care not to lose the ball (which is used as a bearing) in the armature end.

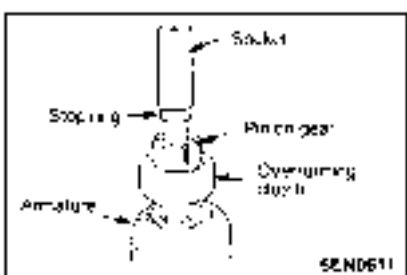
**←→ SNAP RING / STOP RING REMOVAL**

(1) Using an appropriate long socket wrench, tap the stop ring to remove it from the pinion gear side.



(2) Remove snap ring with snap ring pliers and then remove stop ring and overrunning clutch.

**STARTER MOTOR PART CLEANING**

- Do not immerse parts in cleaning solvent. Immersing the yoke end field coil assembly and/or armature will damage insulation. Wipe these parts with a cloth only.
- Do not immerse drive unit in cleaning solvent. Overrunning clutch is pre-lubricated at the factory and solvent will wash lubrication from clutch.
- The drive unit may be cleaned with a brush moistened with cleaning solvent and wiped dry with a cloth.

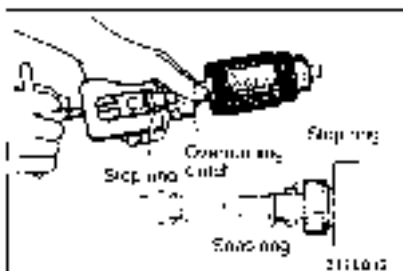
**REASSEMBLY SERVICE POINTS****▶A◀ STOP RING/SNAP RING INSTALLATION**

Using a suitable pulling tool, pull overrunning clutch stop ring over snap ring.

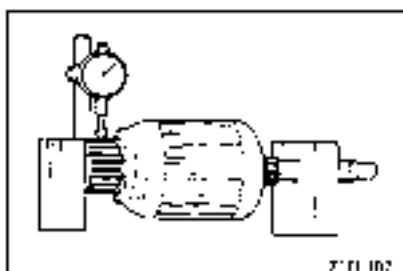
**INSPECTION****COMMUTATOR**

(1) Place the armature in a pair of "V" blocks and check the runout with a dial indicator.

Standard value: 0.05 mm (.002 in.)

Limit: 0.1 mm (.004 in.)

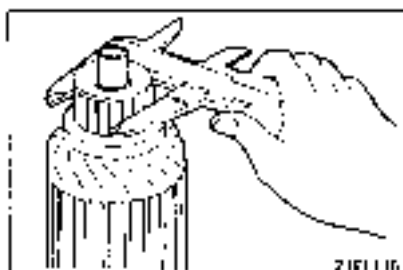

(2) Measure the commutator outer diameter.

<Direct drive type>

Standard value: 32.0 mm (1.260 in.)

Limit: 31.0 mm (1.220 in.)

<Reduction drive type>

Standard value: 29.4 mm (1.158 in.)

Limit: 28.8 mm (1.138 in.)

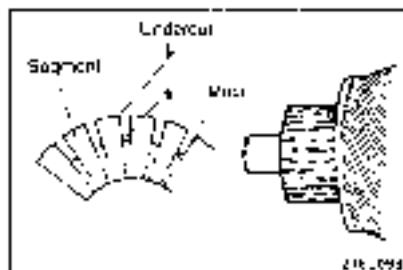

(3) Check the undercut depth between segments.

Standard value: 0.5 mm (.020 in.)

**FIELD COIL OPEN-CIRCUIT TEST (Direct drive type only)**

Check the continuity between field brushes. If there is continuity, the field coil is in order.

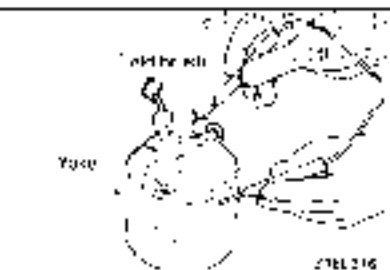

**FIELD COIL GROUND TEST (Direct drive type only)**  
Check the continuity between field coil brush and yoke. If there is no continuity, the field coil is free from grounding.

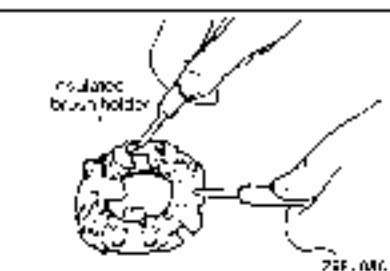

**BRUSH HOLDER CHECK**  
Check the continuity between brush holder plate and brush holder. If there is no continuity, the brush holder is in order.



**OVERRUNNING CLUTCH**

1. While holding clutch housing, rotate the pinion. Drive pinion should rotate smoothly in one direction, but should not rotate in opposite direction. If clutch does not function properly, replace overrunning clutch assembly.
2. Inspect pinion for wear or burrs. If pinion is worn or burred, replace overrunning clutch assembly. If pinion is damaged, also inspect ring gear for wear or burrs.

**FRONT AND REAR BRACKET BUSHING**  
Inspect bushing for wear or burrs. If bushing is worn or burred, replace front bracket assembly or rear bracket assembly.



**BRUSH AND SPRING REPLACEMENT <REDUCTION DRIVE TYPE>**

- 1) Brushes that are worn beyond wear limit line, or oil-soaked, should be replaced.
- 2) When replacing ground brush, slide the brush from brush holder by prying retaining spring back.

**<DIRECT DRIVE TYPE>**

1. Brushes that are worn beyond wear limit line, or are nick-spoked, should be replaced.
2. When replacing field coil brushes, crush worn brush with pliers, taking care not to damage pigtails.

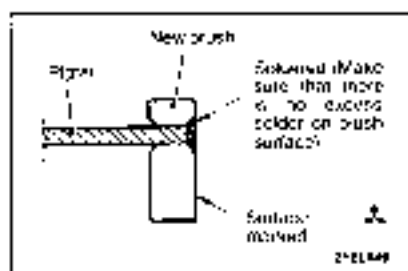

3. Sand pigtail end with sandpaper to ensure good soldering.
4. Insert pigtail into hole provided in new brush and solder it. Make sure that pigtail and excess solder do not come out onto brush surface.
5. When replacing ground brush, slide the brush from brush holder by prying retaining spring back.

**ARMATURE TEST****ARMATURE SHORT-CIRCUIT TEST**

1. Place armature in a growler.
2. Hold a thin steel blade parallel and just above while rotating armature slowly in growler. A shorted armature will cause blade to vibrate and be attracted to the core. Replace shorted armature.

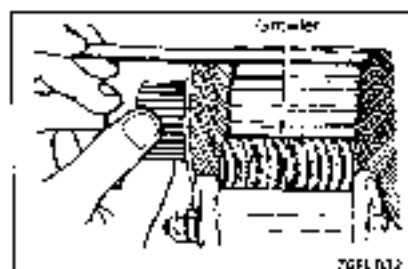
**ARMATURE COIL GROUND TEST**

Check the insulation between each commutator segment and armature coil core.

If there is no continuity, the insulation is in order.

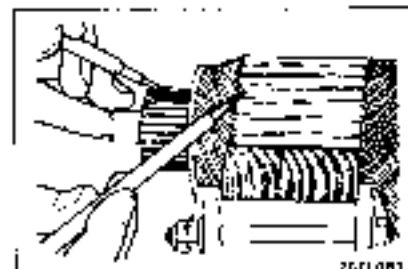
**ARMATURE COIL OPEN-CIRCUIT INSPECTION**

Check the continuity between segments. If there is continuity the coil is in order.

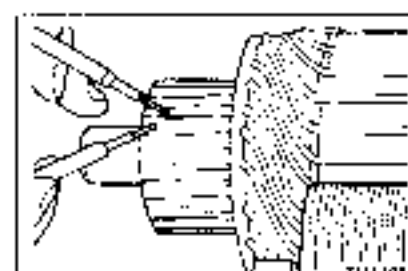

# IGNITION SYSTEM

## GENERAL INFORMATION

### <1.5L Engine>

Interruption of the primary current flowing in the primary side of the ignition coil generates high voltage in the secondary side of the ignition coil. The high voltage thus generated is directed by the distributor to the applicable spark plug. The engine firing order is 1 - 3 - 4 - 2 cylinders. On application of high voltage, the spark plug generates a spark to ignite the compressed air fuel mixture in the combustion chamber. The engine control module makes and breaks the primary current of the ignition coil to regulate the ignition timing.

The engine control module detects the crankshaft position, by the crankshaft position sensor installed at the front end of the crankshaft, to provide ignition at the most appropriate timing for the engine operating condition. When the engine is cold, the ignition timing is slightly advanced to provide optimum performance in the operating condition.

## SYSTEM DIAGRAM

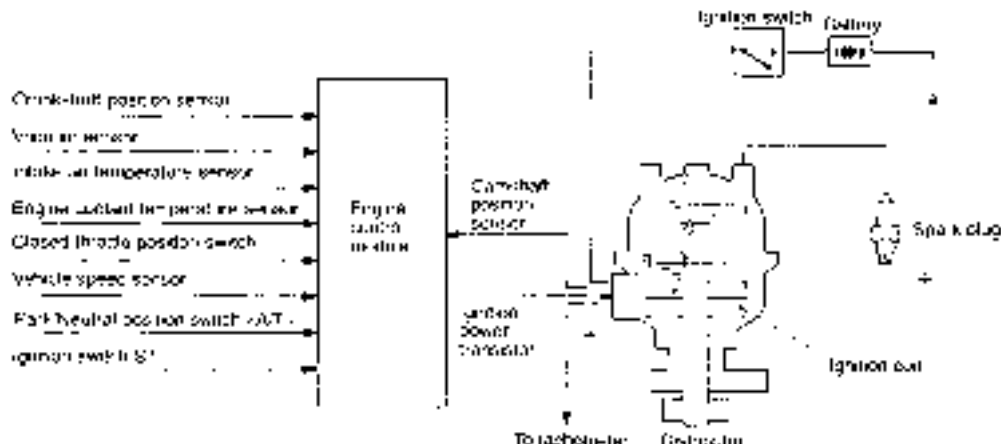

**<1.8L Engine>**

This system is provided with two ignition coils (A and B) with built-in ignition power transistors for the No. 1 and No. 4 cylinders, and No. 2 and No. 3 cylinders respectively.

Interruption of the primary current flowing in the primary side of ignition coil A generates a high voltage in the secondary side of ignition coil A. The high voltage thus generated is applied to the spark plugs of No. 1 and No. 4 cylinders to generate sparks. At the time that the sparks are generated at both spark plugs, one cylinder is at the compression stroke, the other cylinder is at the exhaust stroke, so that ignition of the compressed air/fuel mixture occurs only for the cylinder which is at the compression stroke.

In the same way, when the primary current flowing in ignition coil B is interrupted, the high voltage thus generated is applied to the spark plugs of No. 2 and No. 3 cylinders.

The engine control module controls the two ignition power transistors to turn them alternately ON and OFF. This causes the primary currents in the ignition coils to be alternately interrupted and allowed to flow to fire the cylinders in the order 1 - 3 - 4 - 2.

The engine control module determines which ignition coil should be controlled by means of the signals from the camshaft position sensor which is incorporated in the camshaft and from the crankshaft position sensor which is incorporated in the crankshaft. It also detects the crankshaft position in order to provide ignition at the most appropriate timing in response to the engine operation conditions.

When the engine is cold or operated at high altitudes, the ignition timing is slightly advanced to provide optimum performance.

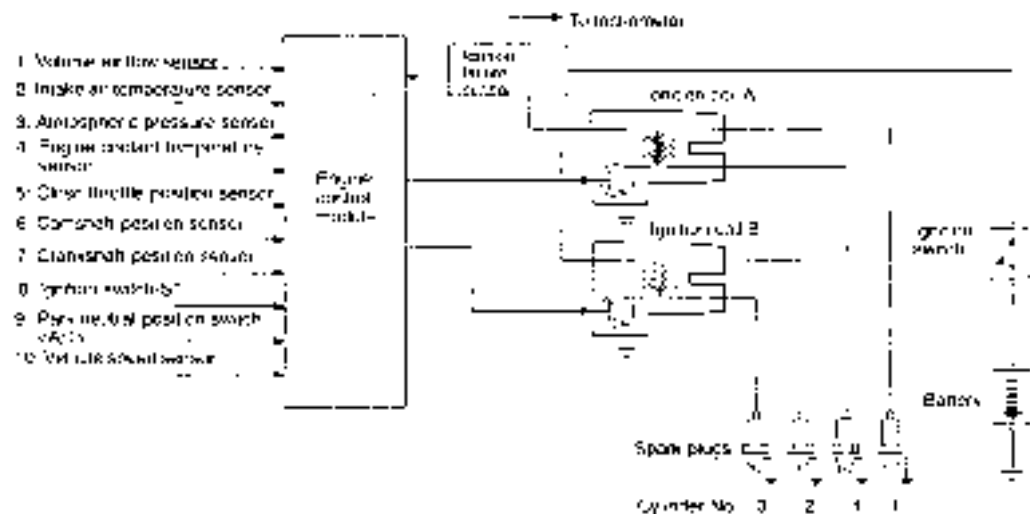
**SYSTEM DIAGRAM**



**DISTRIBUTOR SPECIFICATIONS**

|                   |   |
|-------------------|---|
| Items             | 1.5L Engine                                     |
| Type              | Contact (pointless) with built-in ignition coil |
| Advance mechanism | Electronic                                      |
| Firing order      | 1-3-4-2   |

**IGNITION COIL SPECIFICATION**

|       |  |               |
|-------|--|---------------|
| Items | 1.5L Engine                                    | 1.8L Engine   |
| Type  | Molded single-coil with a built-in distributor | Molded 2-coil |

**SPARK PLUG SPECIFICATION**

|       |          |             |             |
|-------|----------|-------------|-------------|
| Items |          | 1.5L Engine | 1.8L Engine |
| Type  | NGK      | BKR5ES 11   | BKR5E 11    |
|       | DENSO    | W16FR11     | K16FR-U11   |
|       | CHAMPION | PN11YC4     | HC15YC4     |

**OPERATION****<1.5L Engine>**

- Turn ignition switch to "ON" position, and battery positive voltage will be applied to primary winding of ignition coil (incorporated into the distributor).
- When the crankshaft position sensor signal is input to engine control module, ON-OFF control of ignition power transistor is performed by engine control module.
- When ignition power transistor is turned on, current flows from the ignition coil (primary winding) to ground through the ignition power transistor.
- When the ignition power transistor is turned off, high voltage is generated in the primary winding of ignition coil which induces even

higher voltage in the secondary winding, causing a spark at the spark plug(s).

**<1.8L Engine>**

- When the crankshaft position sensor signal is input into the engine control module, the engine control module turns each ignition power transistor ON-OFF, one by one.
- When the ignition power transistor A, (incorporated in the ignition coil 1) is turned from ON to OFF, the spark plugs of No.1 and No.4 cylinders spark. Turning ignition power transistor B, (incorporated in the ignition coil 2) from ON to OFF will produce sparking in spark plugs of No.2 and No.3 cylinders.
- The rest of the operation is the same as described for 1.5L engine.

**SERVICE SPECIFICATIONS**

TK20000172

| Items                                       |                                      | Standard value            | Limit     |
|---|--------------------------------------|---------------------------|-----------|
| Ignition coil                               | Primary coil resistance $\Omega$     | 1.5L Engine               | 0.5 - 0.7 |
|   |                                      | 1.8L Engine               | -         |
|   | Secondary coil resistance k $\Omega$ | 1.5L Engine               | 15 - 22   |
|   |                                      | 1.8L Engine               | 14 - 21   |
| Ignition failure sensor resistance $\Omega$ | 1.8L Engine                          | 2.1 or less               | -         |
| Spark plug gap (mm (in.))                   |                                      | 1.0 - 1.1 (0.039 - 0.043) | -         |
| Spark plug cable resistance k $\Omega$      |                                      | -                         | max. 22   |

## SPECIAL TOOLS

1630963-44

| Tool   | Tool number and name         | Supersession       | Application  |
|--|------------------------------|--------------------|--|
|  | M5991349<br>Test harness set | Tool not available | Inspection of ignition primary voltage (connection of ignition coil connector) |

## TROUBLESHOOTING

1670601009

## TROUBLESHOOTING HINTS

- Engine cranks, but does not start
  - Spark is insufficient or does not occur at all (on spark plug).
    - Check ignition coil
    - Check distributor. <1.5L Engine>
    - Check crankshaft position sensor <1.8L Engine>
    - Check spark plugs.
    - Check spark plug cable.
  - Spark is good
    - Check ignition timing
- Engine idles roughly or stalls
  - Check spark plug
  - Check ignition timing.
  - Check ignition coil.
  - Check spark plug cable
- Poor acceleration
  - Check ignition timing
  - Check spark plug cable
  - Check ignition coil.



## ON-VEHICLE SERVICE

1630000000

## SPARK PLUG CABLE TEST &lt;1.5L Engine&gt;

1. Disconnect, one at a time, each of the spark plug cables while the engine is idling to check whether the engine's running performance changes or not.

**Caution**

Wear rubber gloves and rubber-soled shoes while working on the ignition system.

2. If the engine performance does not change, check the resistance of the spark plug cable, and check the spark plug itself.

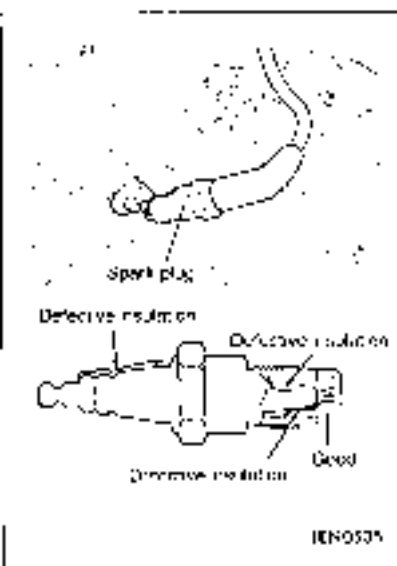

## SPARK PLUG TEST &lt;1.5L Engine&gt;

1630000000

1. Remove the spark plug from the engine and connect it to the spark plug cable boot.
2. Ground the spark plug outer electrode (body) and crank the engine. Check for spark across the electrodes.
3. Remove the spark plug from the boot and visually inspect it for cracks in its insulation.
4. Replace the spark plug if it has a weak spark and/or defective insulation.

## IGNITION COIL CHECK &lt;1.5L Engine&gt;

1630000000

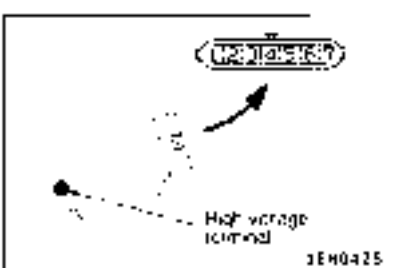

1. Measurement of the primary coil resistance  
Measure the resistance between connector terminal 1 and 2 of the distributor.

**Standard value:** 0.6 - 0.7 Ω

2. Measurement of secondary coil resistance  
Measure the resistance between the high-voltage terminal and connector terminal 1.

**Standard value:** 15 - 22 kΩ

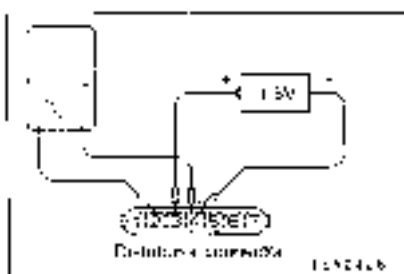

### IGNITION POWER TRANSISTOR CONTINUITY CHECK <1.5L Engine>

16C001261.2

#### NOTE

1. An analog-type ohmmeter should be used.
2. Connect the negative (-) probe of the ohmmeter to terminal 2.

#### Caution

This test must be performed quickly (in less than 10 seconds) to prevent coil from burning and ignition power transistor from breaking.

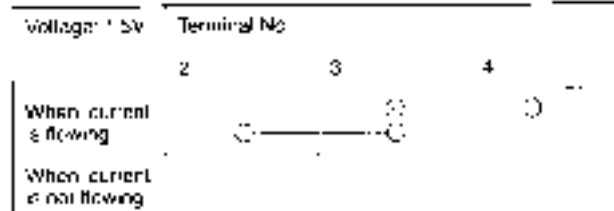

Replace the ignition power transistor if there is a malfunction.

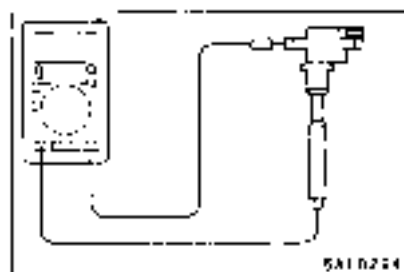

### IGNITION COIL (WITH BUILT-IN IGNITION POWER TRANSISTOR) CHECK <1.8L Engine>

16C001262.2

Check by the following procedure, and replace if there is a malfunction.

#### SECONDARY COIL RESISTANCE CHECK

Measure the resistance between the high-voltage terminals of the ignition coil.

Standard value: 14 - 21 kΩ

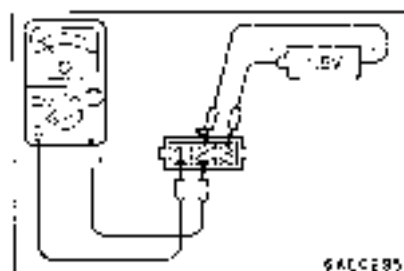

### PRIMARY COIL AND IGNITION POWER TRANSISTOR CONTINUITY CHECK

#### NOTE

1. An analog-type ohmmeter should be used.
2. Connect the negative (-) probe of the ohmmeter to terminal 1.

#### Caution

This test must be performed quickly (in less than 10 seconds) to prevent coil from burning and ignition power transistor from breaking.

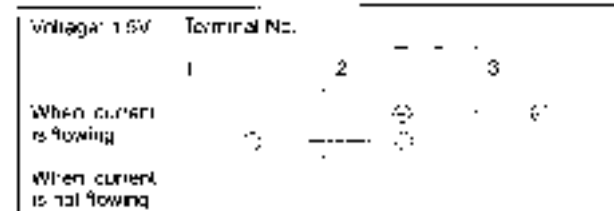

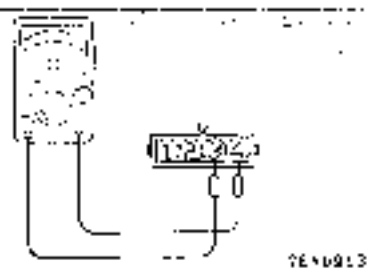

7E10913

### IGNITION FAILURE SENSOR CHECK <1.8L Engine>

1030038031

#### NOTE

An analog-type ohmmeter should be used.  
Check that the resistance between terminals 3 and 4 is at the standard value.

Standard value: 0.1 Ω or less

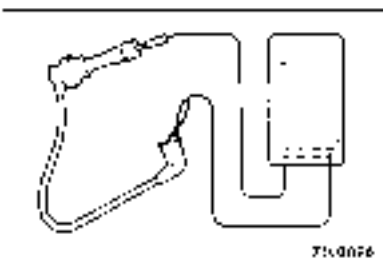

710076

### SPARK PLUG CABLE RESISTANCE CHECK

10300140011

Measure the resistance of the all spark plug leads

- (1) Check cap and coating for cracks.
- (2) Measure resistance.

Limit: max. 22 kΩ

### SPARK PLUG CHECK AND CLEANING

10300190200

1. Remove the spark plug cables

#### Caution

When pulling the spark plug cable boot from the plug, always hold the boot, not the cable.

2. Remove the spark plugs.
3. Check for a burned-out electrode or damaged insulator. Check for even burning.
4. Remove carbon deposits with wire brush or plug cleaner. Remove sand from plug screw with compressed air.

5. Use a gap gauge to check the plug gap.  
Standard value: 1.0 - 1.1 mm (.039 - .043 in.)  
If the plug gap is not within the standard value range, adjust by bending the ground electrode.
6. Clean the engine plug holes.

#### Caution

Do not allow foreign matter to enter the cylinders.

7. Install the spark plugs.

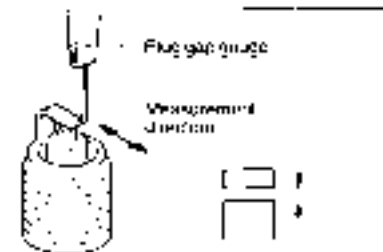

0910182

## CAMSHAFT POSITION SENSOR AND CRANKSHAFT POSITION SENSOR CHECK

14300280467

<4G15 Engine>

Refer to GROUP 13A - Troubleshooting

<4G93 Engine>

Refer to GROUP 13B - Troubleshooting

## IGNITION SECONDARY VOLTAGE WAVEFORM CHECK

14300170046

<1.5L Engine>

### MEASUREMENT METHOD

1. Clamp the spark plug cable of the No. 1 cylinder with the secondary pickup and check the waveforms for each cylinder.
2. Connect the secondary pickup to the other cylinder in turn and check the waveforms for each cylinder.

### STANDARD WAVEFORM

Observation conditions

|                |                  |
|----------------|------------------|
| FUNCTION       | SECONDARY        |
| PATTERN HEIGHT | HIGH (or LOW)    |
| PATTERN SPREAD | RASTER           |
| Engine Speed   | Crui. idle speed |

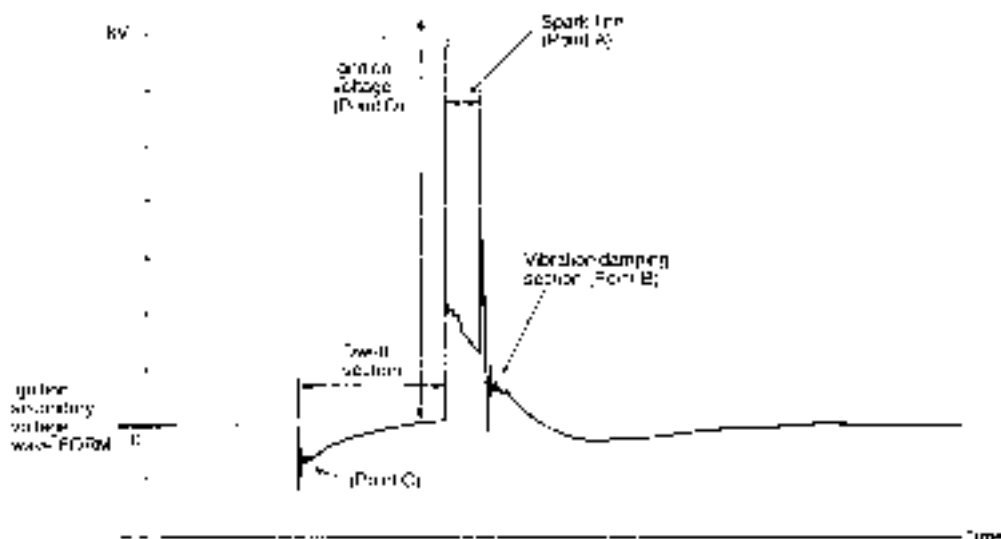

**WAVEFORM OBSERVATION POINTS**

**Point A:** The height, length and slope of the spark line (refer to Abnormal Waveform Examples 1, 2, 3 and 4) show the following trends.

| Spark line    | Plug gap | Condition of electrode | Compression force | Concentration of air mixture | Ignition timing | Spark plug cable |
|---------------|----------|------------------------|-------------------|------------------------------|-----------------|------------------|
| Length: Long  | Small    | Normal                 | Low               | Rich                         | Advanced        | Leak             |
| Length: Short | Large    | Large wear             | High              | Lean                         | Retarded        | High resistance  |
| Height: High  | Large    | Large wear             | High              | Lean                         | Retarded        | High Resistance  |
| Height: Low   | Small    | Normal                 | Low               | Rich                         | Advanced        | Leak             |
| Slope         | Large    | Plug is fouled         | -                 | -                            | -               | -                |

**Point B:** Number of vibrations in reduction vibration section  
(Refer to Abnormal Waveform Example 5)

| Number of vibrations | Cul and conciser |
|----------------------|------------------|
| Three or more        | Normal           |
| Except above         | Abnormal         |



**Point C:** Number of vibrations at beginning of dwell section  
(Refer to Abnormal Waveform Example 6)

| Number of vibrations | Cul      |
|----------------------|----------|
| 5-6 or higher        | Normal   |
| Except above         | Abnormal |

**Point D:** Ignition voltage height (distribution per each cylinder) shows the following trends

| Ignition voltage | Plug gap | Condition of electrode | Compression force | Concentration of air mixture | ignition timing | Spark plug cable |
|------------------|----------|------------------------|-------------------|------------------------------|-----------------|------------------|
| High             | Large    | Large wear             | High              | Lean                         | Retarded        | High resistance  |
| Low              | Small    | Normal                 | Low               | Rich                         | Advanced        | Leak             |

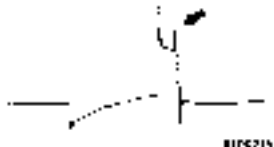
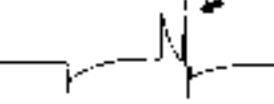
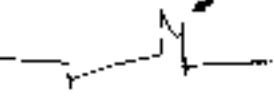
## ABNORMAL WAVEFORMS EXAMPLES

| Abnormal waveform   | Wave characteristics  | Cause of problem   |
|---|---|--|
| <p>Example 1</p>  <p>FIGURE 1</p>   | <p>Spark line is high and short.</p>  | <p>Spark plug gap is too large.</p>                                      |
| <p>Example 2</p>  <p>FIGURE 2</p>   | <p>Spark line is low and long, and is sloping.<br/>Also, the second half of the spark line is distorted. This could be a result of misfiring.</p> | <p>Spark plug gap is too small.</p>                                      |
| <p>Example 3</p>  <p>FIGURE 3</p>   | <p>Spark line is low and long, and is sloping. However, there is almost no spark line distortion.</p>   | <p>Spark plug gap is fouled.</p>   |
| <p>Example 4</p>  <p>FIGURE 4</p>  | <p>Spark line is high and short.<br/>Difficult to distinguish between this and abnormal wave pattern example 1.</p>                               | <p>Spark plug cable is nearly falling off (causing a dual ignition).</p> |
| <p>Example 5</p>  <p>FIGURE 5</p> | <p>No waves in wave damping section.</p>  | <p>Layer short in ignition coil.</p>                                     |



## &lt;1.8L Engine&gt;

**MEASUREMENT METHOD**

1. Clamp the SECONDARY PICKUP around the spark plug cable.

**NOTE**

1. The peak ignition voltage will be reversed when the spark cables No.2 and No.4, or No.1 and No.3 cylinders are clamped.
  2. Because of the two-cylinder simultaneous ignition system, the waveforms for two cylinders in each group appear during wave form observation (No.1 cylinder - No.4 cylinder - No.2 cylinder - No.3 cylinder). However, wave form observation is only applicable for the cylinder with the spark plug cable clamped by the secondary pickup.
  3. Identifying which cylinder waveform pattern is displayed can be difficult. For reference, remember that the waveform pattern of the cylinder attached to the secondary pickup will be displayed as stable.
2. Clamp the spark plug cable with the Trigger pickup.

**NOTE**

Clamp the trigger pickup to the same spark plug cable clamped by the secondary pickup.

**STANDARD WAVEFORM****Observation Conditions**

|                    |                |
|--------------------|----------------|
| FUNCTION           | SECONDARY      |
| PATTERN HEIGHT     | HIGH (or .75V) |
| PATTERN SELECTOR   | HASTFR         |
| Engine revolutions | Crabdle speed  |

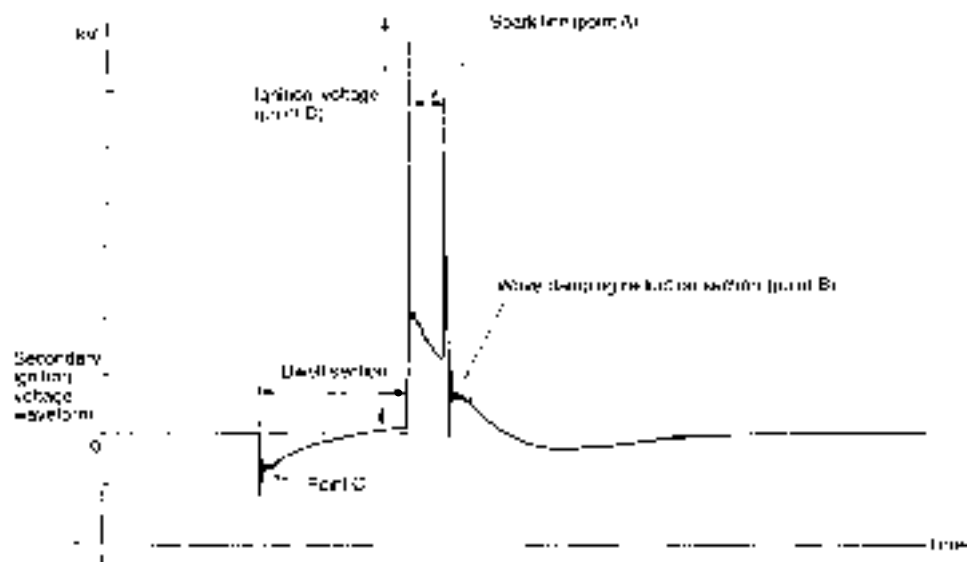

7 ELD147

Observation Condition (The only change from above condition is the pattern selector.)

|                  |           |
|------------------|-----------|
| PATTERN SELECTOR | D DISPLAY |
|------------------|-----------|

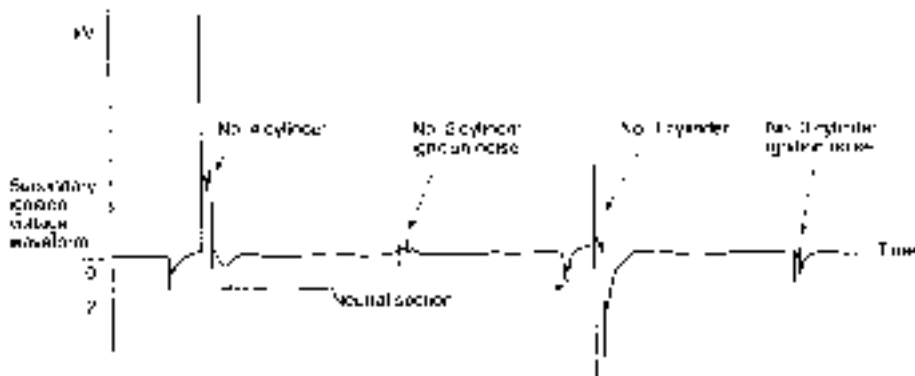

610742

#### WAVEFORM OBSERVATION POINTS

For waveform observation points, refer to P.16-39.

#### ABNORMAL WAVEFORMS EXAMPLES

For examples of abnormal waveforms, refer to P.16-45.

## IGNITION PRIMARY VOLTAGE WAVEFORM CHECK

16300-170007

<1.5L Engine>

### MEASUREMENT METHOD

1. Disconnect the distributor connector and connect the special tool (test harness MB891348) in between. (All of the terminals should be connected.)

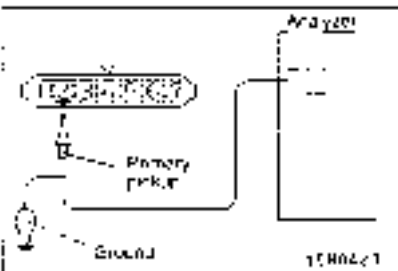

2. Connect the analyzer primary pickup to the distributor connector terminal 2.
3. Connect the primary pickup ground terminal
4. Clamp the spark plug cable with the trigger pickup.

### NOTE

The waveform of the cylinder clamped to the trigger pickup will appear at the left edge of the screen.

## STANDARD WAVEFORM

FIGURE 16-10

## Observation conditions

|                  |                 |
|------------------|-----------------|
| FUNCTION         | PRIMARY         |
| PATTERN HEIGHT   | HIGH (or LOW)   |
| PATTERN SELECTOR | MASTER          |
| Engine Speed     | Crab idle speed |

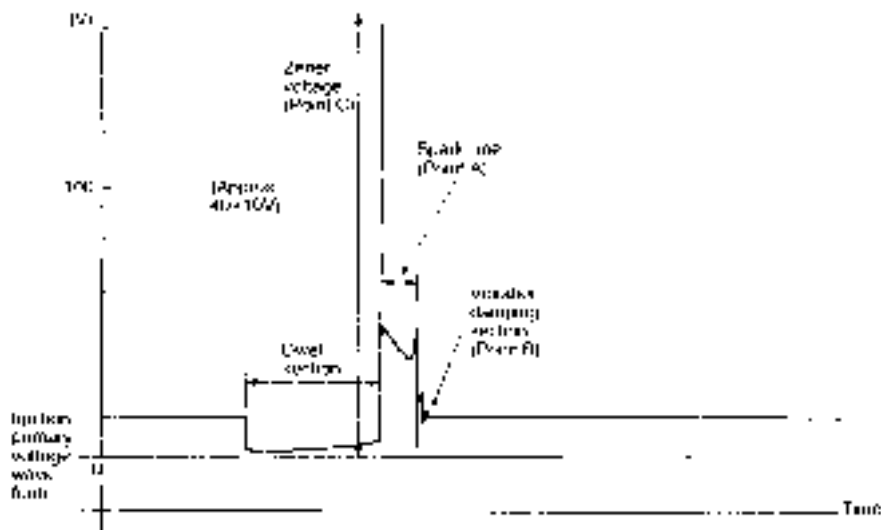

7ELD102

## Observation conditions

(Only the pattern selector shown here changes from the previous conditions)

|                  |         |
|------------------|---------|
| PATTERN SELECTOR | DISPLAY |
|------------------|---------|

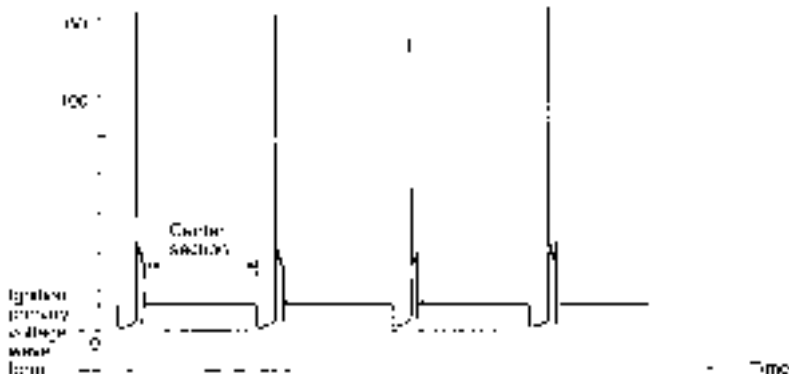

## WAVEFORM OBSERVATION POINTS

## Point A

The height, length and slope of the spark line (refer to Abnormal Waveform Examples 1, 2, 3 and 4) show the following trends:

| Spark line   | Plug gap | Condition of electrode | Compression force | Concentration of air mixture | Ignition timing | Spark plug cable |
|--------------|----------|------------------------|-------------------|------------------------------|-----------------|------------------|
| Length Long  | Small    | Normal                 | Low               | Rich                         | Advanced        | Loak             |
| Length Short | Large    | Large wear             | High              | Lean                         | Retarded        | High resistance  |
| Height High  | Large    | Large wear             | High              | Lean                         | Retarded        | High Resistance  |
| Height Low   | Small    | Normal                 | Low               | Rich                         | Advanced        | Loak             |
| Slope        | Large    | Plug is fouled         | -                 | -                            | -               | -                |

## Point B



Number of vibrations in reduction vibration section  
(Refer to Abnormal Waveform Example 5)

| Number of vibrations | Coil condition |
|----------------------|----------------|
| 3 or higher          | Except above   |
| Normal               | Abnormal       |

## Point C: Height of Zener voltage

| Height of Zener voltage | Probable cause                              |
|-------------------------|---|
| High                    | Problem in Zener diode                      |
| Low                     | Abnormal resistance in primary coil circuit |

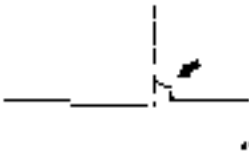
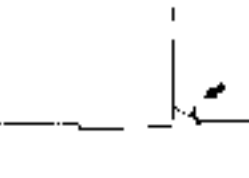
## ABNORMAL WAVEFORM EXAMPLES

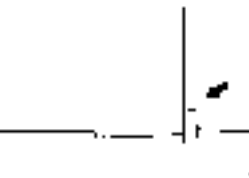
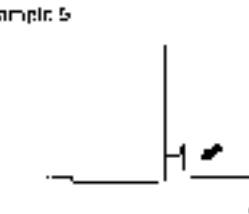
| Abnormal waveform   | Wave characteristics   | Cause of problem             |
|---|--|------------------------------|
| Example 1   | Spark line is high and short   | Spark plug gap is too large  |
|   | Spark line is low and long, and is sloping. Also, the second half of the spark line is distorted. This could be a result of misfiring. | Spark plug gap is too small  |
| Example 2   | Spark line is low and long, and is sloping. However, there is almost no spark line distortion.   | Spark plug gap is fouled     |
|   | Example 3  | Spark line is high and short |
|   | Spark plug cable is nearly falling off (causing a dual ignition)   |                              |
| Example 4   | No waves in wave damping section   | Layer short in ignition coil |
|  |    |                              |
| Example 5   |  |                              |

## IGNITION SYSTEM &lt;1.5L Engine&gt;

14C0007012A

## REMOVAL AND INSTALLATION

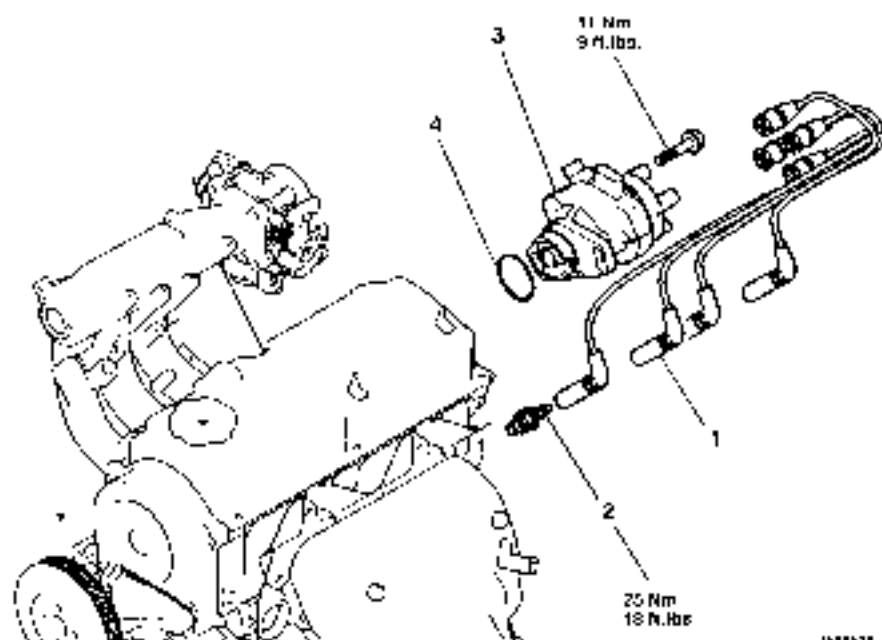

## Removal steps

- 1 Spark plug cable
- 2 Spark plug
- ▶A◀ 3 Distributor
- 4 O-ring

## INSTALLATION SERVICE POINT

## ▶A◀ DISTRIBUTOR INSTALLATION

- (1) Turn the crankshaft so that the No. 1 cylinder is at top dead center.
- (2) Install the distributor to the engine while aligning the distributor housing and coupling mating marks.



## IGNITION SYSTEM &lt;1.8L Engine&gt;

6820-6-01

## REMOVAL AND INSTALLATION

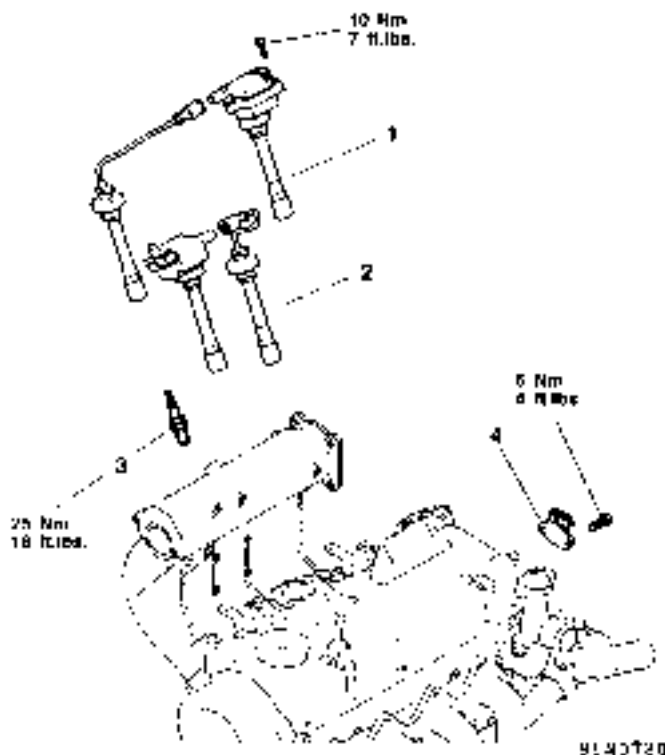

## Removal Step:

1. Ignition coil
2. Spark plug wire
3. Spark plug
4. Ignition failure sensor



**DISTRIBUTOR <1.5L Engine>**

16-00020126

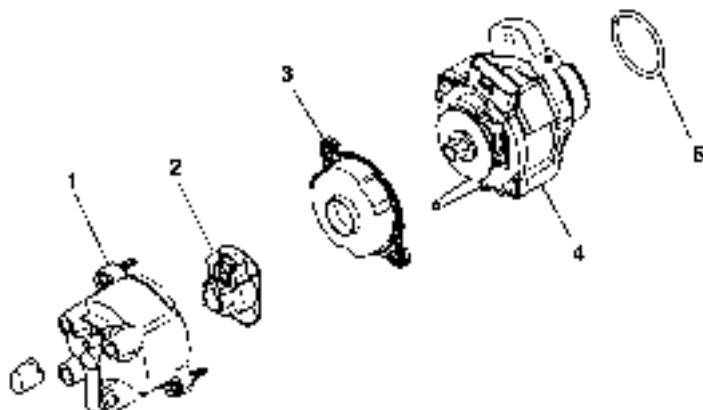
**DISASSEMBLY AND REASSEMBLY**

16-49-1A

**Disassembly steps**

1. Distributor cap
2. Rotor
3. Cover
4. O-ring
5. Distributor housing

**INSPECTION**

16-00030088

Check the following points, repair or replace if a problem is found.

**CAP ROTOR**

- (1) There must be no cracking in the cap.
- (2) There must be no damage to the cap's electrode or the rotor's electrode.
- (3) Clean away any dirt from the cap and rotor.

# CAMSHAFT POSITION SENSOR AND CRANKSHAFT POSITION SENSOR

16300780-100

## REMOVAL AND INSTALLATION

&lt;1.6L Engine&gt;

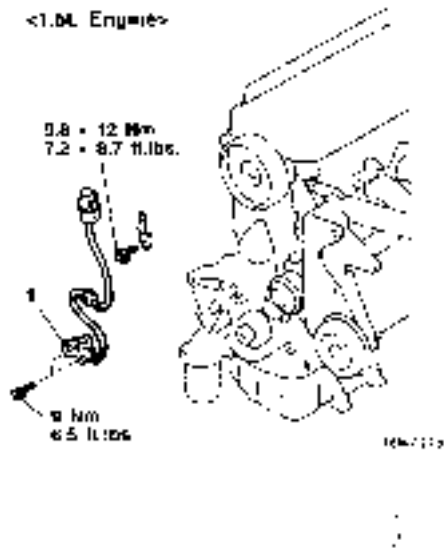

&lt;1.8L Engine&gt;

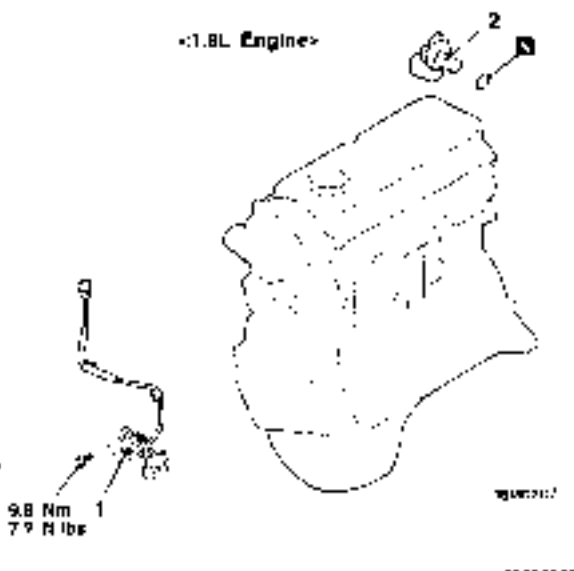

4

1. Crankshaft position sensor
2. Crankshaft position sensor

## INSPECTION

1630026050

### CAMSHAFT POSITION SENSOR, CRANKSHAFT POSITION SENSOR CHECK

Refer to GROUP 13A - Troubleshooting <1.5L Engine>, GROUP 13B - Troubleshooting <1.8L Engine - Crankshaft position sensor>, or GROUP 13B - Troubleshooting <1.8L Engine - Camshaft position sensor>.