

Handbook



PEUGEOT **208**



Exterior

Stop & Start

This system puts the engine temporarily into standby during stops in the traffic (red lights, traffic jams, etc...). The engine restarts automatically as soon as you want to move off. Perfectly suited to urban use, the Stop & Start system reduces fuel consumption, exhaust emissions and the noise level when stationary.

▶ 95



Cornering lighting

At low speed this system provides additional lighting in corners, at junctions, when parking..., making use of the corresponding front foglamp.

▶ 114

Electronic stability programme

This system allows you to maintain the directional stability of the vehicle, within the laws of physics.

▶ 123

Exterior

Temporary puncture repair kit

This kit is a complete system consisting of a compressor and a sealant cartridge, to allow the temporary repair of a tyre.

▶ 143

Panoramic sunroof

Equipped with configurable light guides, this large sunroof provides incomparable visibility and lighting in the passenger compartment.

▶ 56



Rear parking sensors

This system provides a warning when manoeuvring backwards by detecting obstacles located behind the vehicle.

▶ 104

Open

Remote control key

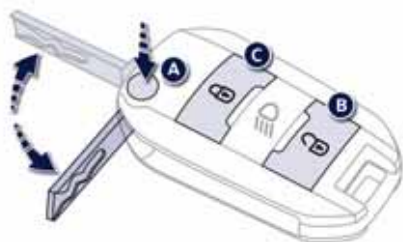

- A. Unfolding / Folding the key.
- B. Unlocking the vehicle.

- i** Other functions...
- C. Normal locking of the vehicle
Vehicle location.

▶ 44

Fuel tank



- 1. Opening the fuel filler flap.
- 2. Opening the fuel filler cap.

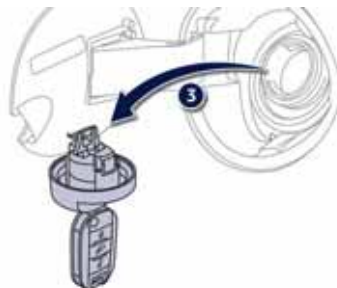

- 3. Hooking the fuel filler cap.
- Tank capacity: approximately 50 litres.

▶ 186

Bonnet

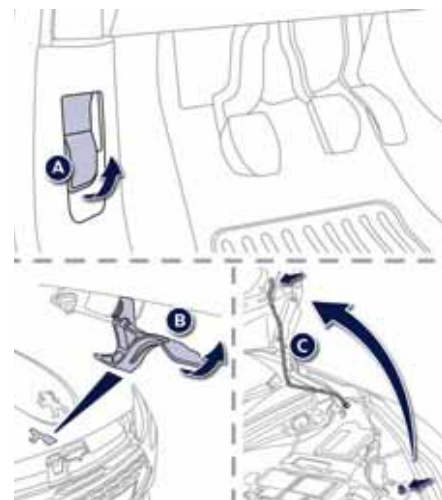

- A. Interior release lever.
- B. Exterior safety catch
- C. Bonnet stay.

▶ 183

Interior

Interior mood lighting

This subdued passenger compartment lighting improves visibility inside the vehicle in low lighting conditions. It comprises several lamps, located below the instrument panel, in the footwells, in the courtesy lamp and on each side of the panoramic sunroof.

▶ 120

Electronic gearbox

This gearbox provides driving that combines a completely automatic mode and a manual mode.

5-speed

▶ 85

6-speed

▶ 88

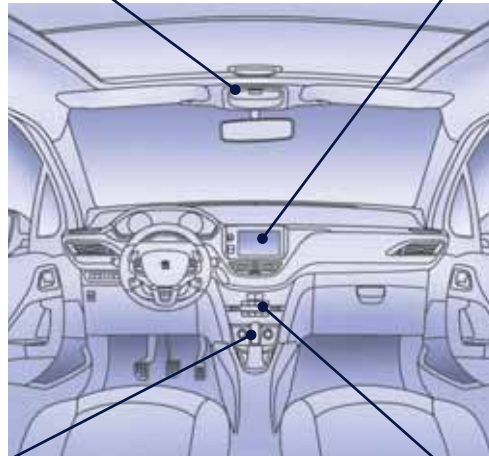

Audio and communication systems

These systems benefit from the latest technology: MP3 compatible audio systems, USB player, Bluetooth hands-free system, satellite navigation system with colour screen, auxiliary inputs, Hi-Fi audio system, ...

Touch screen

▶ 211

Bluetooth audio system

▶ 271

Audio system

▶ 297

Dual zone digital air conditioning

After setting the desired level of comfort, the system then automatically controls this level according to the ambient conditions.

▶ 70

Instruments and controls

1. Cruise control / speed limiter controls.
2. Steering mounted controls for the touch screen.
3. Lighting and direction indicator stalk.
4. Wiper / screenwash / trip computer stalk.
5. Bonnet release lever.
6. Steering wheel adjustment control.
7. Driver's airbag.
Horn.
8. Headlamp height adjustment.
9. Switch panel.
10. Side adjustable air vents.
11. Front side window demisting/defrosting vent.
12. Instrument panel.
13. Windscreen demisting/defrosting vent.
14. Sunshine sensor.
15. Glove box / Passenger's airbag deactivation.
16. Passenger's airbag.
17. Multifunction screen / Audio system.
18. Central adjustable air vents.
19. Central locking and hazard warning buttons.
20. Heating / air conditioning controls.
21. 12 V accessory socket.
USB port / auxiliary socket.
Additional USB port.
22. Open storage.
Cup holder.
23. Gear lever.
24. Central armrest with storage.
25. Parking brake.

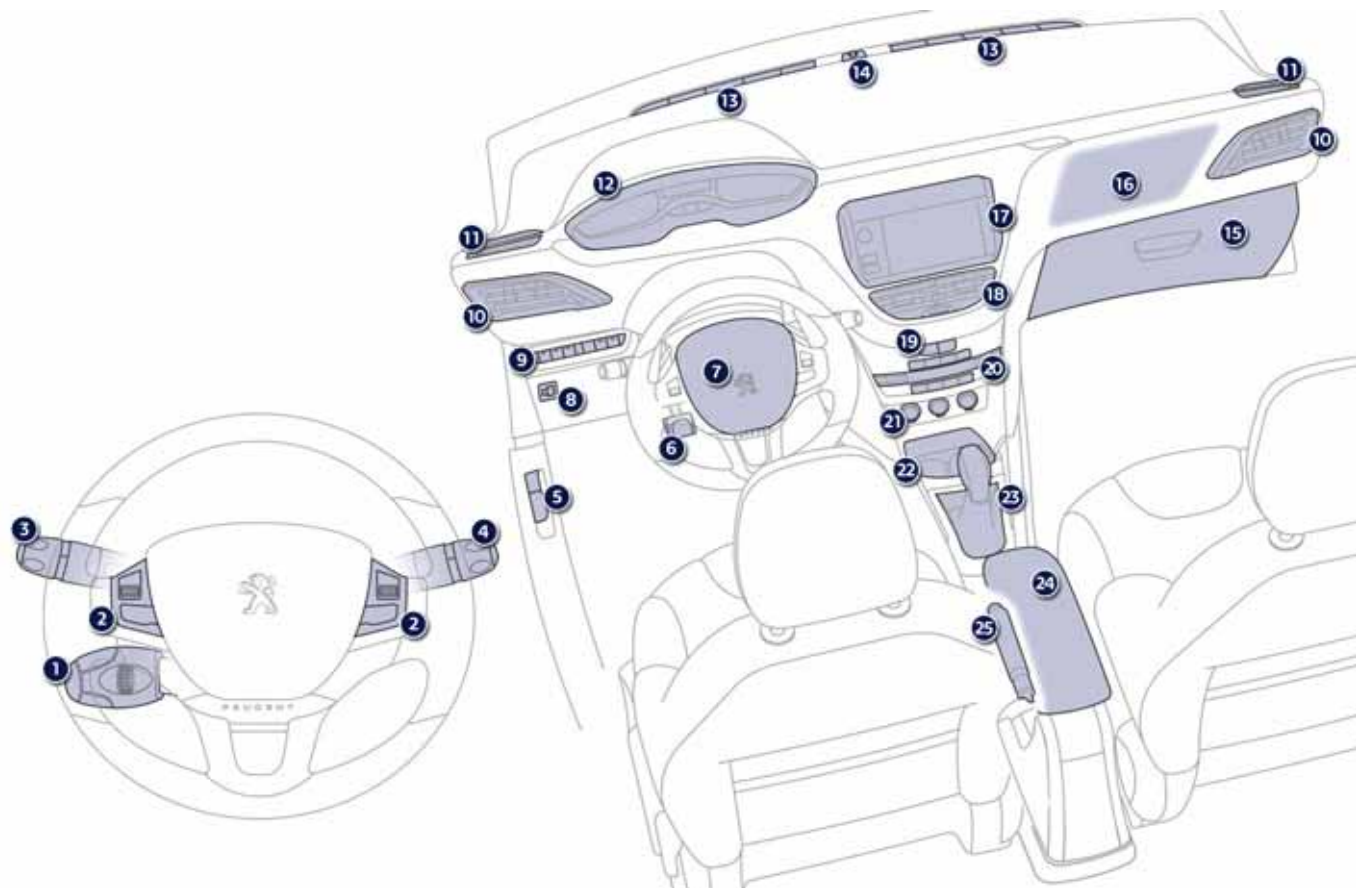

Sitting comfortably

Front seats

Manual adjustments

1. Head restraint height adjustment.
2. Backrest angle adjustment.
3. Seat cushion height adjustment.
4. Seat forwards-backwards adjustment.

▶ 57



Sitting comfortably

Head restraint adjustment



To raise the head restraint, pull it upwards.
To lower it, press the lug **A** and down on the head restraint at the same time.

▶ 58

Steering wheel adjustment

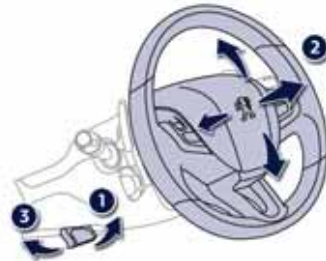

1. Release the adjustment mechanism.
2. Adjust for height and reach.
3. Lock the adjustment mechanism.

! For reasons of safety, these operations must only be carried out with the vehicle stationary.

▶ 65

Heated seats control

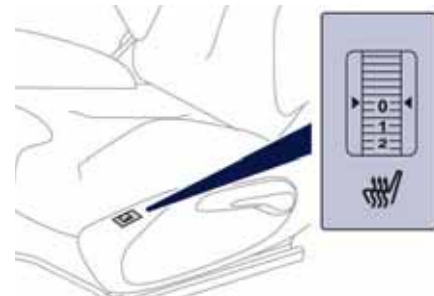

- 0: off.
- 1: low.
- 2: medium.
- 3: high.

▶ 59

Sitting comfortably

Door mirrors



Adjustment

- A. Selection of the mirror.
- B. Adjusting the position of the mirror glass.
- C. De-selection of the mirror.

▶ 63

i Other functions...
Folding / Unfolding.

Rear view mirror

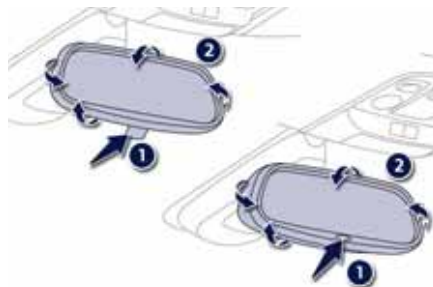

Manual day/night type

1. Selecting the "day" position of the rear view mirror.
2. Rear view mirror adjustment.

Automatic day/night type

1. Automatic detection of day/night mode.
2. Rear view mirror adjustment.

▶ 64

Front seat belts

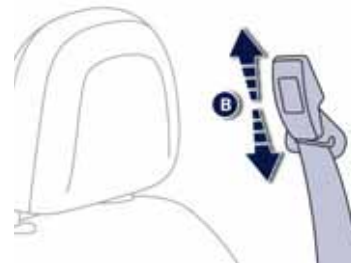
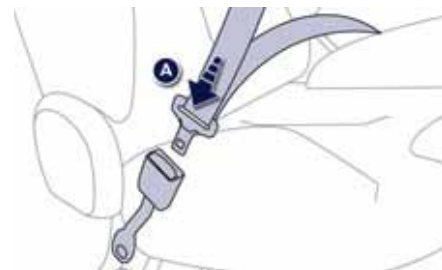

- A. Fastening.
- B. Height adjustment (5-door).

▶ 126

Seeing clearly

Lighting

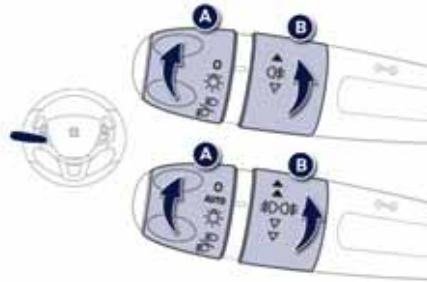

Ring A



Lighting off.



Automatic illumination of headlamps.



Sidelamps.



Dipped / main beam headlamps.

Ring B



Rear foglamp.

or



Front and rear foglamps.



Wipers

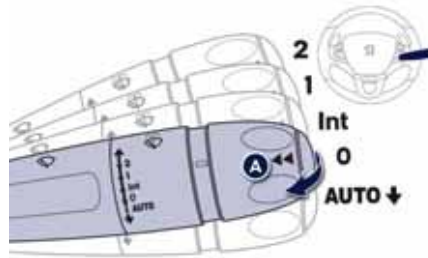

Control stalk A: windscreen wipers

2. Fast wipe.

1. Normal wipe.

Int. Intermittent wipe.

0. Park.

AUTO Automatic wiping.

↓ Single wipe: Brief pull on the stalk towards.

Screenwash: Long pull on stalk towards you.

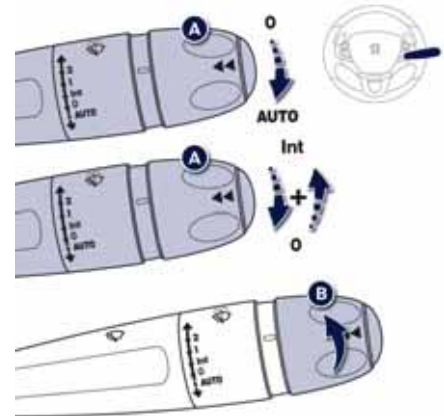

Switching on "AUTO" mode

☞ Briefly push the stalk downwards.

Switching off "AUTO" mode

☞ Briefly push the stalk downwards or place the stalk in another position: Int, 1 or 2.



Ring B: rear wiper



Park.



Intermittent wipe.











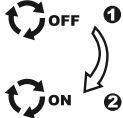

Screenwash.

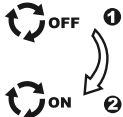

Ventilation

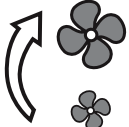
Recommended interior settings

I require...	Heating or Manual air conditioning				
	Air distribution	Air flow	Air recirculation/ Intake of exterior air	Temperature	Manual AC
HOT					
COLD					ON
DEMISTING DEFROSTING					ON

Digital air conditioning: use the automatic mode in preference by pressing the "AUTO" button.

Monitoring

Instrument panels

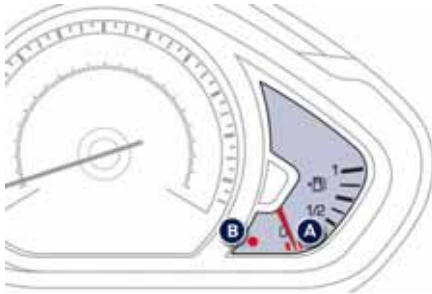

On switching on, the dial needles go to the extent of their travel then return to 0.

- A. With the ignition on, the needle should indicate the fuel remaining.
- B. With the engine running, the associated low level warning lamp should go off.

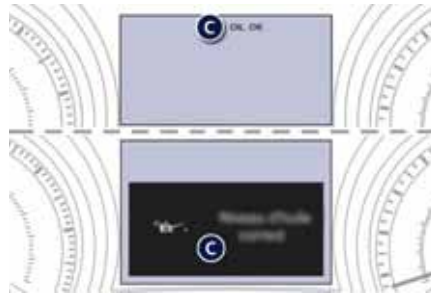

- C. With the ignition on, the instrument panel screen should indicate the level of oil. If the levels are not correct, top up the level which is low.

▶ 21

Warning lamps

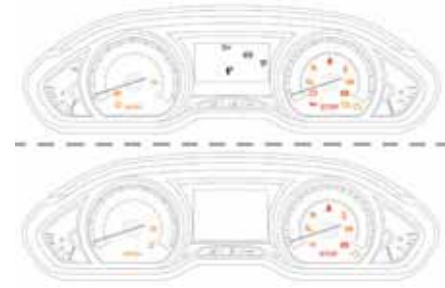

1. With the ignition on, the orange and red warning lamps come on.
2. With the engine running, these warning lamps should go off.

If a warning lamp remains on, refer to the page concerned.

▶ 23, 28

Monitoring Switch panel

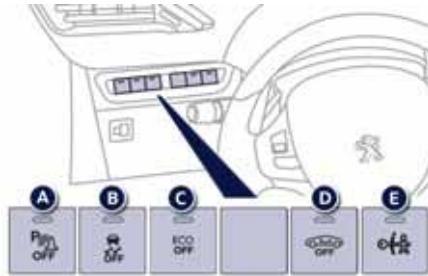

Illumination of the lamp indicates the status of the corresponding function.

A. Deactivation of rear parking sensors.

▶ 105

B. Deactivation of the DSC/ASR system.

▶ 125

C. Deactivation of the Stop & Start system.

▶ 96

D. Volumetric alarm monitoring off.

▶ 52

E. Electric child lock on.

▶ 142

Passenger safety Front passenger's airbag



1. Open the glove box.
2. Insert the key.
3. Select position:
"ON" (activation), with front passenger or "forwards facing" child seat,
"OFF" (deactivation), with "rear facing" child seat.
4. Remove the key keeping the switch in the new position.

▶ 130

Front seat belts and passenger's front airbag



A. Front seat belts not fastened or unfastened warning lamp.

B. Airbag fault warning lamp.

▶ 32

C. Front passenger's airbag deactivation warning lamp.

▶ 27

Driving safely

Stop & Start

Going into engine STOP mode

ECO The "ECO" warning lamp comes on in the instrument panel and the engine goes into standby:

- **with a manual gearbox**, at speeds below 12 mph (20 km/h), when you put the gear lever into neutral, and you release the clutch pedal,
- **with an electronic gearbox**, at speeds below 5 mph (8 km/h), when you press the brake pedal or you put the gear lever into position **N**.

In certain circumstances, STOP mode may not be available; the "ECO" warning lamp flashes for a few seconds, then goes off.



95

Going into engine START mode

ECO The "ECO" warning lamp goes off and the engine restarts:

- **with a manual gearbox**, when you press the clutch pedal,
- **with an electronic gearbox**:
 - with the gear lever in position **A** or **M**, when you release the brake pedal,
 - or with the gear lever in position **N** and brake pedal released, when you move the gear lever to position **A** or **M**,
 - or when you engage reverse.

In certain circumstances, START mode may be invoked automatically; the "ECO" warning lamp flashes for a few seconds, then goes off.



96

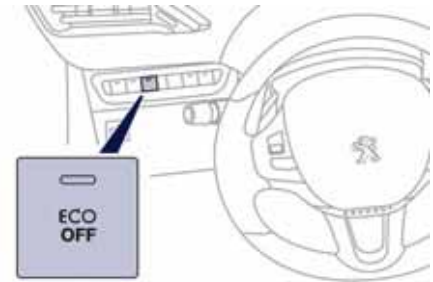

Deactivation / Reactivation

You can deactivate the system at any time by pressing the "ECO OFF" button; the button's warning lamp comes on.

i The system is automatically reactivated every time the engine is started with the key.

! Before refuelling or doing anything under the bonnet, you must switch off the ignition with the key.



96

Driving safely

Speed limiter "LIMIT"

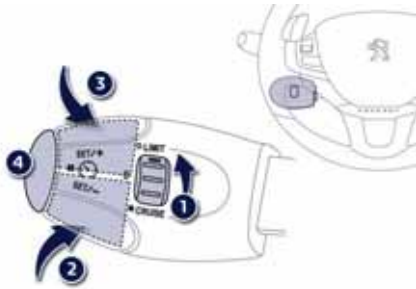

1. Selecting speed limiter mode.
2. Decrease the programmed value.
3. Increase the programmed value.
4. Speed limiter On / Off.

The values must be set with the engine running.

▶ 99

Cruise control "CRUISE"

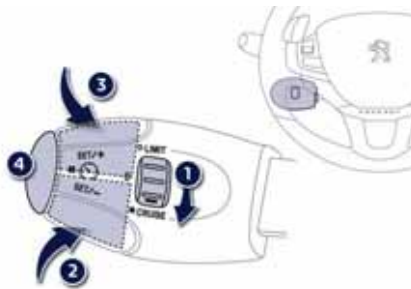

1. Selecting cruise control mode.
2. Decrease the programmed value.
3. Increase the programmed value.
4. Cruise control Off / Resume.

In order to be programmed or activated, the vehicle speed must be higher than 25 mph (40 km/h), with at least 4th gear engaged on a manual gearbox (2nd gear on an electronic or automatic gearbox).

▶ 101

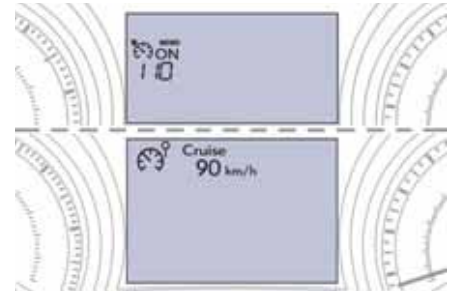

Display in the instrument panel

The cruise control or speed limiter mode appears in the instrument panel when it is selected.



Cruise control



Speed limiter

Eco-driving

Eco-driving is a range of everyday practices that allow the motorist to optimise their fuel consumption and CO₂ emissions.

Optimise the use of your gearbox

With a manual gearbox, move off gently, change up without waiting and drive by changing up quite soon. If your vehicle has the system, the gear shift indicator invites you to change up; it is displayed in the instrument panel, follow its instructions.

With an automatic or electronic gearbox, stay in Drive "**D**" or Auto "**A**", according to the type of gearbox, without pressing the accelerator pedal heavily or suddenly.

Drive smoothly

Maintain a safe distance between vehicles, use engine braking rather than the brake pedal, and press the accelerator progressively. These practices contribute towards a reduction in fuel consumption and CO₂ emissions and also helps reduce the background traffic noise.

If your vehicle has cruise control, make use of the system at speeds above 25 mph (40 km/h) when the traffic is flowing well.

Control the use of your electrical equipment

Before moving off, if the passenger compartment is too warm, ventilate it by opening the windows and air vents before using the air conditioning.

Above 30 mph (50 km/h), close the windows and leave the air vents open.

Remember to make use of equipment that can help keep the temperature in the passenger compartment down (sunroof and window blinds...).

Switch off the air conditioning, unless it has automatic digital regulation, as soon as the desired temperature is attained.

Switch off the demisting and defrosting controls, if not automatic.

Switch off the heated seat as soon as possible.

Switch off the headlamps and front foglamps when the level of light does not require their use.

Avoid running the engine before moving off, particularly in winter; your vehicle will warm up much faster while driving.

As a passenger, if you avoid connecting your multimedia devices (film, music, video game...), you will contribute towards limiting the consumption of electrical energy, and so of fuel.

Disconnect your portable devices before leaving the vehicle.

Limit the causes of excess consumption

Spread loads throughout the vehicle; place the heaviest items in the bottom of the boot, as close as possible to the rear seats.

Limit the loads carried in the vehicle and reduce wind resistance (roof bars, roof rack, bicycle carrier, trailer...). Use a roof box in preference.

Remove roof bars and roof racks after use.

At the end of winter, remove snow tyres and refit your summer tyres.

Observe the recommendations on maintenance

Check the tyre pressures regularly, when cold, referring to the label in the door aperture, driver's side.

Carry out this check in particular:

- before a long journey,
- at each change of season,
- after a long period out of use.

Don't forget the spare wheel and the tyres on any trailer or caravan.

Have your vehicle serviced regularly (engine oil, oil filter, air filter...) and observe the schedule of operations recommended by the manufacturer.

When refuelling, do not continue after the 3rd cut-off of the nozzle to avoid any overflow.

At the wheel of your new vehicle, it is only after the first 1 800 miles (3 000 kilometres) that you will see the fuel consumption settle down to a consistent average.

LCD instrument panel



Dials and screens

1. Engine coolant temperature gauge.
2. Rev counter (x 1 000 rpm or tr/min), graduation according to engine (petrol or Diesel).
3. Engine oil level indicator.
4. Gear shift indicator for a manual gearbox or gear lever position and gear for an electronic or automatic gearbox.
5. Digital speedometer (mph or km/h)
This can be switched off with a long press on **B**.
6. Cruise control or speed limiter settings.
7. Service indicator, then total distance recorder (miles or km).
These functions are displayed successively on switching on the ignition.
8. Trip distance recorder (miles or km).
9. Analogue speedometer (mph or km/h).
10. Fuel gauge.

Control buttons

- A.** General lighting dimmer.
- B.** Recall the service information. Reset the function selected (service indicator or trip distance recorder). Setting the time. Switching the digital speedometer on and off.

Active matrix instrument panel



Dials and screens

1. Engine coolant temperature gauge.
2. Rev counter (x 1 000 rpm or tr/min), graduation according to engine (petrol or Diesel).
3. Cruise control or speed limiter settings.
4. Gear shift indicator for a manual gearbox or gear lever position and gear for an electronic or automatic gearbox.
5. Speedometer (mph or km/h).
6. Service indicator, then total distance recorder (miles or km). These functions are displayed successively on switching on the ignition.
7. Trip distance recorder (miles or km).
8. Analogue speedometer (mph or km/h).
9. Fuel gauge.

Control buttons

- A. Main lighting dimmer.
- B. Instrument panel mood lighting.
- C. Recall of the service information. Reset the selected function (service indicator or trip distance recorder).

Indicator and warning lamps

Visual indicators informing the driver that a system is in operation, switched off or has a fault.



When the ignition is switched on

Certain warning lamps come on for a few seconds in the instrument panel and/or instrument panel screen when the vehicle's ignition is switched on.

When the engine is started, these same warning lamps should go off.

If they remain on, before moving off, refer to the information on the warning lamp concerned.

Associated warnings

The switching on of certain warning lamps may be accompanied by an audible signal and a message in the instrument panel or multifunction screen.







The warning lamps may come on continuously (fixed) or flash.



Certain warning lamps may come on in one of two modes. Only by relating the type of lighting to the operating status of the vehicle can it be ascertained whether the situation is normal or whether a fault has occurred.



Operation indicator lamps



If one of the following indicator lamps comes on in the instrument panel and/or instrument panel screen, this confirms that the corresponding system has come into operation.

Warning / indicator lamp	State	Cause	Action / Observations
 Left-hand direction indicator	flashing with buzzer.	The lighting stalk is pushed down.	
 Right-hand direction indicator	flashing with buzzer.	The lighting stalk is pushed up.	
 Sidelamps	fixed.	The lighting stalk is in the "Sidelamps" position.	
 Dipped beam headlamps	fixed.	The lighting stalk is in the "Dipped beam headlamps" position.	
 Main beam headlamps	fixed.	The lighting stalk is pulled towards you.	Pull the stalk to return to dipped beam headlamps.
 Front foglamps	fixed.	The front foglamps are switched on.	Turn the ring on the stalk rearwards twice to switch off the front foglamps.
 Rear foglamp	fixed.	The rear foglamp is switched on.	Turn the ring on the stalk rearwards to switch off the rear foglamp.



For more information on the lighting controls, refer to the "Visibility" section.



Warning / indicator lamp		State	Cause	Action / Observations
	Diesel engine pre-heating	fixed.	The ignition switch is at the 2nd position (ignition on).	Wait until the warning lamp goes off before starting. The period of illumination of the warning lamp is determined by the climatic conditions (up to about thirty seconds in extreme climatic conditions). If the engine does not start, switch the ignition off and then on, wait until the warning lamp goes off again, then start the engine.
	Parking brake	fixed.	The parking brake is applied or not properly released.	Release the parking brake to switch off the warning lamp, keeping your foot on the brake pedal. Observe the safety recommendations. For further information on the parking brake, refer to the "Driving" section.
	Foot on the brake pedal	fixed.	The brake pedal must be pressed.	With an electronic gearbox, press the brake pedal to start the engine (lever in position N). With an automatic gearbox, with the engine running, press the brake pedal before releasing the parking brake, to unlock the lever and come out of position P . If you wish to release the parking brake without pressing the brake pedal, this warning lamp will remain on.
		flashing.	With an electronic gearbox, if you hold the vehicle on an incline using the accelerator for too long, the clutch overheats.	Use the brake pedal and/or the parking brake.

Warning / indicator lamp	State	Cause	Action / Observations
 Foot on the clutch*	fixed.	In the STOP mode of Stop & Start, changing to START mode is refused because the clutch pedal is not fully down.	You must declutch fully to allow the change to engine START mode.
 Automatic wiping	fixed.	The wiper control is pushed downwards.	Automatic front wiping is activated. To deactivate automatic wiping, operate the control stalk downwards or put the stalk into another position.
 Stop & Start	fixed.	When the vehicle stops (red lights, traffic jams,...) the Stop & Start system has put the engine into STOP mode.	The warning lamp goes off and the engine restarts automatically in START mode, as soon as you want to move off.
	flashes for a few seconds, then goes off.	STOP mode is temporarily unavailable. or START mode is invoked automatically.	Refer to "Driving - § Stop & Start" for special cases with STOP mode and START mode.

* Except for the active matrix instrument panel.

Deactivation indicator lamps

If one of the following indicator lamps comes on, this confirms that the corresponding system has been switched off intentionally. This is may be accompanied by an audible signal and a message in the screen.

Warning / indicator lamp		State	Cause	Action / Observations
	Passenger's airbag system	fixed.	The control, located in the glove box, is set to the OFF position. The passenger's front airbag is deactivated. In this case you can install a "rear facing" child seat.	Set the control to the ON position to activate the passenger's front airbag. In this case, do not fit a child seat in the rear-facing position.
	Dynamic stability control (DSC/ASR)	fixed.	The button, located at the bottom left of the dashboard, is pressed. Its indicator lamp is on. The DSC/ASR is deactivated. DSC: dynamic stability control. ASR: anti-slip regulation.	Press the button to activate the DSC/ASR. Its indicator lamp goes off. The DSC/ASR system is activated automatically when the vehicle is started. If deactivated, the system is reactivated automatically from around 30 mph (50 km/h).



Warning lamps





When the engine is running or the vehicle is being driven, illumination of one of the following warning lamps indicates a fault which requires action on the part of the driver.



Any fault resulting in the illumination of a warning lamp must be investigated further by reading the associated message in the screen.



If you encounter any problems, contact a PEUGEOT dealer or a qualified workshop.

Warning / indicator lamp		State	Cause	Action / Observations
STOP	STOP	fixed, associated with another warning lamp.	It is associated with the engine oil pressure or the engine coolant temperature.	Stop as soon as it is safe to do so. Park, switch off the ignition and call a PEUGEOT dealer or qualified workshop.
SERVICE	Service	on temporarily.	Minor faults have occurred for which there is no specific warning lamp.	Identify the fault by reading the message shown in the screen, such as, for example: <ul style="list-style-type: none"> - the engine oil level, - saturation of the particle emissions filter (Diesel). - the power steering, - a minor electrical fault. - ... For any other faults, contact a PEUGEOT dealer or a qualified workshop.
		fixed.	Major faults have occurred for which there is no specific warning lamp.	Identify the fault by reading the message shown in the screen and then contact a PEUGEOT dealer or qualified workshop.

Warning / indicator lamp	State	Cause	Action / Observations
 Braking	fixed.	The braking system fluid level has dropped significantly.	You must stop as soon as it is safe to do so. Top up with brake fluid listed by PEUGEOT. If the problem persists, have the system checked by a PEUGEOT dealer or a qualified workshop.
	fixed, associated with the ABS warning lamp.	The electronic brake force distribution (EBFD) system has a fault.	You must stop as soon as it is safe to do so. Have it checked by a PEUGEOT dealer or a qualified workshop.
 Maximum coolant temperature	fixed with the needle in the red zone.	The temperature of the cooling system is too high.	Stop as soon as it is safe to do so. Wait until the engine has cooled down before topping up the level, if necessary. If the problem persists, contact a PEUGEOT dealer or a qualified workshop.

Warning / indicator lamp		State	Cause	Action / Observations
	Anti-lock Braking System (ABS)	fixed.	The anti-lock braking system has a fault.	The vehicle retains conventional braking. Drive carefully at reduced speed and contact a PEUGEOT dealer or a qualified workshop without delay.
	Dynamic stability control (DSC/ASR)	flashing.	The DSC/ASR regulation is operating.	The system optimises traction and improves the directional stability of the vehicle.
		fixed.	Unless it has been deactivated (button pressed and its indicator lamp on) the DSC/ASR system has a fault.	Have it checked by a PEUGEOT or a qualified workshop.
 	Engine autodiagnosis system	fixed.	The emission control system has a fault.	The warning lamp should go off when the engine is started. If it does not go off, contact a PEUGEOT dealer or qualified workshop without delay.
		flashing.	The engine management system has a fault.	Risk of destruction of the catalytic converter. Have it checked by a PEUGEOT dealer or a qualified workshop.
	Low fuel level	fixed with the needle in the red zone.	When it first comes on there remains approximately 5 litres of fuel in the tank. At this point, you begin to use the fuel reserve.	Refuel as soon as possible to avoid running out of fuel. This warning lamp will come on every time the ignition is switched on, until a sufficient addition of fuel is made. Fuel tank capacity: approximately 50 litres . Never continue to drive until you run out of fuel, as this could damage the emission control and injection systems.

Warning / indicator lamp		State	Cause	Action / Observations
	Engine oil pressure	fixed.	There is a fault with the engine lubrication system.	You must stop as soon it is safe to do so. Park, switch off the ignition and contact a PEUGEOT dealer or a qualified workshop.
	Battery charge	fixed.	The battery charging circuit has a fault (dirty or loose terminals, slack or cut alternator belt, ...).	The warning lamp should go off when the engine is started. If it does not go off, contact a PEUGEOT dealer or a qualified workshop.
	Door(s) open	fixed, associated with a message identifying the door, if the speed is below 6 mph (10 km/h).	A door or the boot is still open.	Close the door or boot.
		fixed, associated with a message identifying the door, and accompanied by an audible signal if the speed is above 6 mph (10 km/h).		

Warning / indicator lamp	State	Cause	Action / Observations
 Seat belt(s) not fastened / unfastened	fixed then flashing accompanied by an increasing audible signal.	A seat belt has not been fastened or has been unfastened.	Pull the strap then insert the tongue in the buckle.
 Airbags	on temporarily.	This lamp comes on for a few seconds when you turn on the ignition, then goes off.	This lamp should go off when the engine is started. If it does not go off, contact a PEUGEOT dealer or a qualified workshop.
	fixed.	One of the airbag or seat belt pretensioner systems has a fault.	Have it checked by a PEUGEOT dealer or a qualified workshop.
 Power steering	fixed.	The power steering has a fault.	Drive carefully at reduced speed. Have it checked by a PEUGEOT dealer or a qualified workshop.